

200 : TIGER-MATE CASE IH FIELD CULTIVATOR

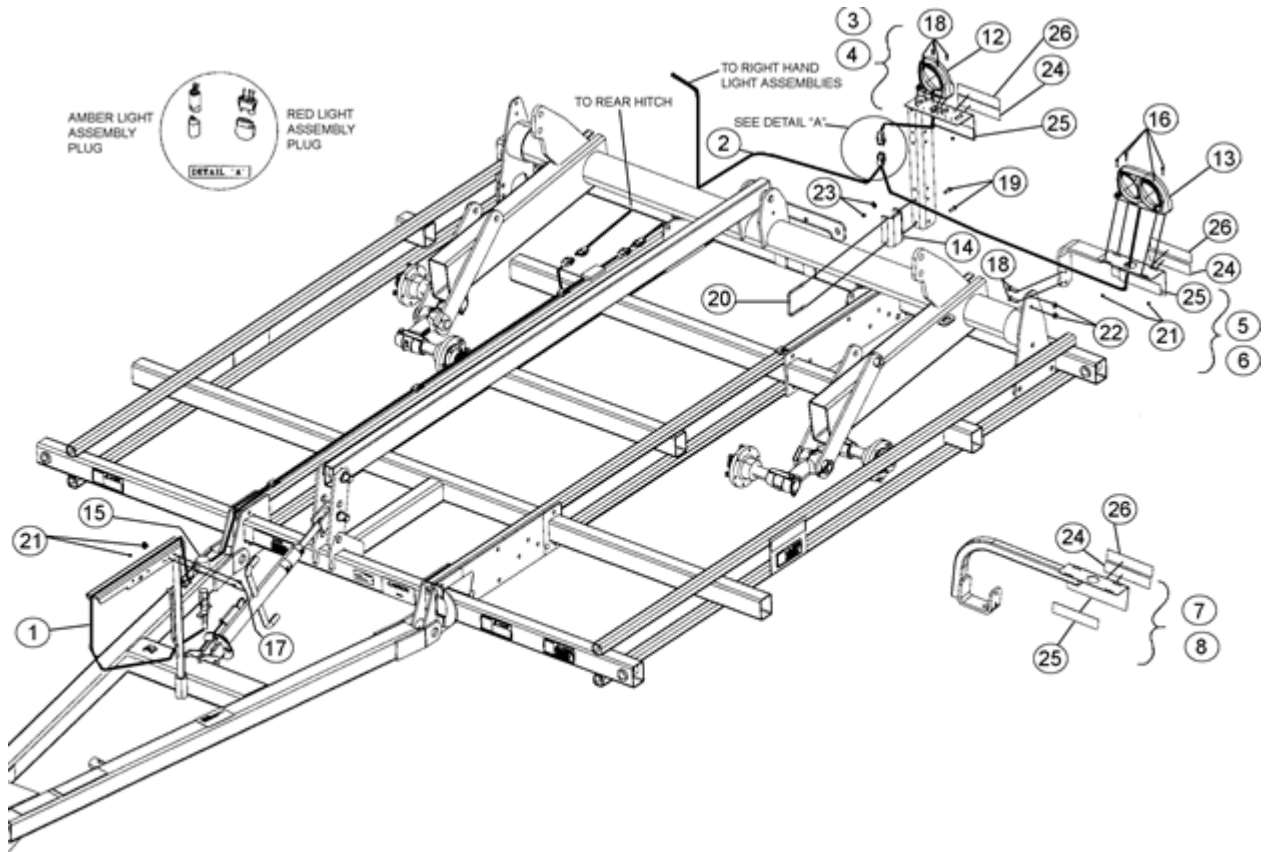













































55.404.01 - WARNING AND TAIL LIGHT KIT SINGLE FOLD 12-1/2 THROUGH 38-1/2



GS08A003

200 : TIGER-MATE CASE IH FIELD CULTIVATOR

55.404.01 - WARNING AND TAIL LIGHT KIT SINGLE FOLD 12-1/2 THROUGH 38-1/2

Ссылка	Кол-во	Номер по каталогу	Описание	ОН	Индикаторы
1	1	8755578	HARNESS, WIRE Front		 
2	1	87446754	HARNESS, WIRE Rear		  
3	1	87328898	BRACKET Left, Assembly Inc. 24 - 26, Used On All Sizes Of Units		
4	1	87328897	BRACKET Right, Assembly Inc. 24 - 26, Used On All Sizes Of Units		
5	1	87556829	BRACKET Left, Assembly Inc. 24 - 26, Used On 20 And 22 Foot Units Only		
6	1	87556828	BRACKET Right Assembly Inc. 24 - 26, Used On 20 And 22 Foot Units Only		
7	1	87556815	BRACKET Left, Assembly Inc. 24 - 26, Used On 18, 24, 28-32, & 38 Foot Units Only		
8	1	87556814	BRACKET Right, Assembly Inc. 24 - 26, Used On 18, 24, 28-32, & 38 Foot Units Only		
12	1	87520382	LIGHT Red, Single, Rh		
12	1	87519398	LIGHT Red, Single, Lh		
13	2	87519394	LIGHT Amber		
14	2	87415482	BRACKET		
15	1	27601214	HOLDER Plug		
16	16	413-420	BOLT Hex, 1/4"-20 x 1 1/4", G5,		 
17	2	413-412	BOLT Hex, 1/4"-20 x 3/4", G5, Full Thd,		  
18	4	413-824	BOLT Hex, 1/2"-13 x 1 1/2", G5, Full Thd,		 
19	4	413-620	BOLT Hex, 3/8"-16 x 1 1/4", G5, Full Thd,		  
20	2	87629083	U-BOLT		
21	18	86992211	NUT, LOCK 1/4, NC		 
22	4	86992215	NUT, LOCK 1/2"-13, GC, Stover		  
23	8	86992213	NUT, LOCK 3/8, NC, Stover		 
24	4	311863A1	REFLECTOR Red		  
25	4	311864A1	REFLECTOR Yellow		  
26	4	311865A1	REFLECTOR Flouresent		  
27	1	87435657	HARNESS Rear, Hitch, Wesbar, 2005 And Prior Units		  
27	1	87446767	HARNESS, WIRE Rear Hitch, Cobo, 2006 And After Units		
28	UAR	533959R1	STRAP, CABLE .135" x 11", (Not Shown)		 
28	UAR	386170C1	STRAP, CABLE .30" x 27 1/2", 27-1/2, Tie, (Not Shown)		   
29	UAR	27601215	LENS Replacement, Amber (Not Shown)		
29	UAR	27601216	LENS Replacement, Red (Not Shown)		

200 : TIGER-MATE CASE IH FIELD CULTIVATOR



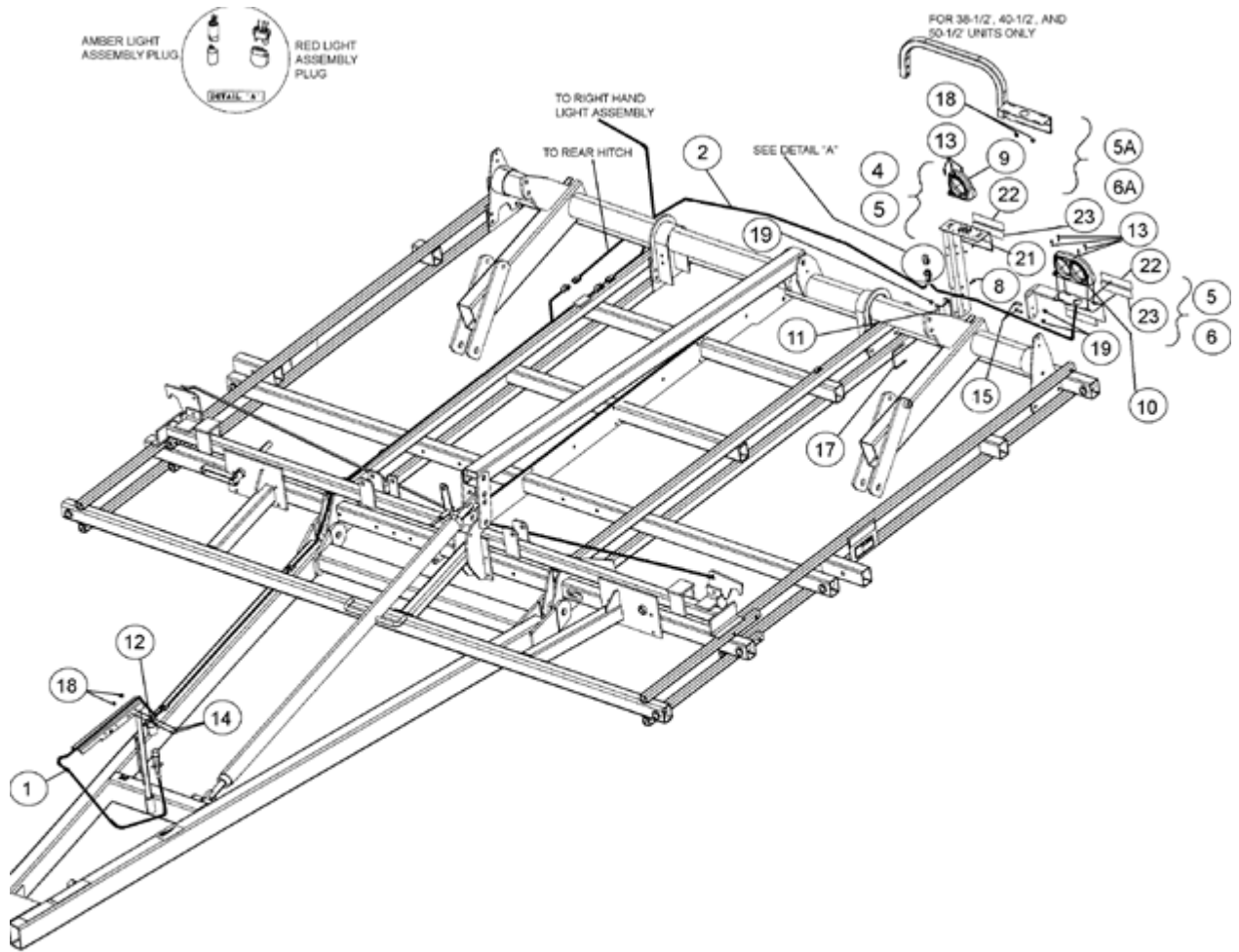











































55.404.02 - WARNING AND TAILLIGHT KIT 38-1/2 TO 50-1/2 MODELS



GS08A004

200 : TIGER-MATE CASE IH FIELD CULTIVATOR

55.404.02 - WARNING AND TAILLIGHT KIT 38-1/2 TO 50-1/2 MODELS

Ссылка	Кол-во	Номер по каталогу	Описание	ОН	Индикаторы
1	1	8755578	HARNESS, WIRE Front		 
2	1	87446754	HARNESS, WIRE Rear		  
3	1	87328898	BRACKET Left, Assembly, Inc. 21 - 23		
4	1	87328897	BRACKET Right, Assembly, Inc. 21 - 23		
5	1	87556837	BRACKET Right, Assembly, Inc. 21 - 23		
5A	1	87556831	BRACKET Right, Assembly , Inc. 21 - 23, Used On 2007 Models And After, 38.5, 40.5, and 50.5 Units		
5A	1	06402130	SUPPORT Light, Right, Inc. 21 - 23, Used On 2006 And Prior Models, 38.5, 40.5, and 50.5 Units		
6	1	87556841	BRACKET Left, Assembly, Inc. 21 - 23		
6A	1	87556834	BRACKET Left, Assembly, Inc 21 - 23, Used On 2007 And After Models, 38.5, 40.5, and 50.5 Units		
6A	1	06402120	SUPPORT Left, Assembly, Inc. 21 - 23, Used On 2006 And Prior Models, 38.5, 40.5, and 50.5 Units		
9	1	87520382	LIGHT Red, Single, Rh		
9	1	87519398	LIGHT Red, Single, Lh		
10	2	87519394	LIGHT Amber		
11	2	87415482	BRACKET		
12	1	27601214	HOLDER Plug		
13	16	413-420	BOLT Hex, 1/4"-20 x 1 1/4", G5,		 
14	2	413-412	BOLT Hex, 1/4"-20 x 3/4", G5, Full Thd,		  
15	4	413-824	BOLT Hex, 1/2"-13 x 1 1/2", G5, Full Thd,		 
16	4	413-620	BOLT Hex, 3/8"-16 x 1 1/4", G5, Full Thd,		  
17	2	87629083	U-BOLT		
18	18	86992211	NUT, LOCK 1/4, NC		 
19	4	86992215	NUT, LOCK 1/2"-13, GC, Stover		  
20	8	86992213	NUT, LOCK 3/8, NC, Stover		 
21	4	311864A1	REFLECTOR Yellow		  
22	4	311865A1	REFLECTOR Fluorescent		  
23	4	311863A1	REFLECTOR Red		  
24	1	87435657	HARNESS Rear Hitch		  
25	UAR	533959R1	STRAP, CABLE .135" x 11", (Not Shown)		 
25	UAR	386170C1	STRAP, CABLE .30" x 27 1/2", Tie (Not Shown)		   
26	UAR	27601215	LENS Amber (Not Shown)		

200 : TIGER-MATE CASE IH FIELD CULTIVATOR

55.404.02 - WARNING AND TAILLIGHT KIT 38-1/2 TO 50-1/2 MODELS

Ссылка	Кол-во	Номер по каталогу	Описание	ОН	Индикаторы
26	UAR	27601216	LENS Red (Not Shown)		
26	UAR	84178558	LENS Amber (Not Shown), Oval, Used On 87519394 Light Assembly		
26	UAR	84178560	LENS Red (Not Shown), Oval		

200 : TIGER-MATE CASE IH FIELD CULTIVATOR



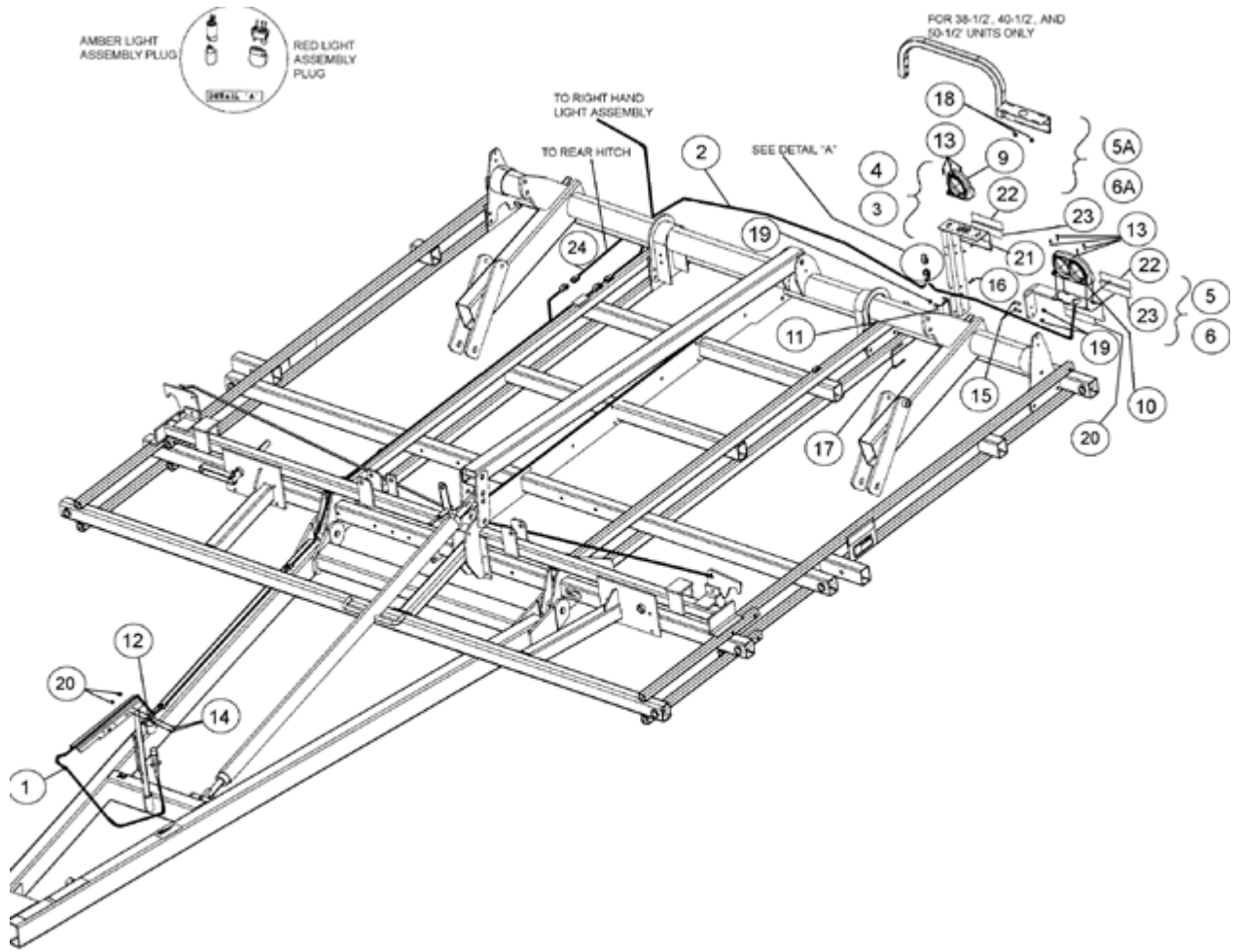











































55.404.03 - WARNING AND TAILLIGHT KIT 54-1/2 THROUGH 60-1/2 MODELS



GS08A004

200 : TIGER-MATE CASE IH FIELD CULTIVATOR

55.404.03 - WARNING AND TAILLIGHT KIT 54-1/2 THROUGH 60-1/2 MODELS

Ссылка	Кол-во	Номер по каталогу	Описание	ОН	Индикаторы
1	1	87555578	HARNESS, WIRE Front		 
2	1	87446754	HARNESS, WIRE Rear		  
3	1	87328898	BRACKET Left, Assembly, Inc. 21 - 23		
4	1	87328897	BRACKET Right, Assembly, Inc. 21 - 23		
5	1	87556837	BRACKET Right, Assembly, Inc. 21 - 23		
5A	1	87556831	BRACKET Light, Right, Inc. 21 - 23, Used On 2007 And After Models		
5A	1	06402130	SUPPORT Light, Right, Inc. 21 - 23, Used On 2006 And Prior Models		
6	1	87556841	BRACKET Left, Assembly, Inc. 21 - 23		
6A	1	87556834	BRACKET Light, Left, Inc. 21 - 23, Used On 2007 And After Models		
6A	1	06402120	SUPPORT Light, Left, Inc. 21 - 23, Used On 2006 And Prior Models		
9	1	87520382	LIGHT Red, Single, Rh		
9	1	87519398	LIGHT Red, Single, Lh		
10	2	87519394	LIGHT Amber		
11	2	87415482	BRACKET		
12	1	27601214	HOLDER Plug		
13	16	413-420	BOLT Hex, 1/4"-20 x 1 1/4", G5,		 
14	2	413-412	BOLT Hex, 1/4"-20 x 3/4", G5, Full Thd,		  
15	4	413-824	BOLT Hex, 1/2"-13 x 1 1/2", G5, Full Thd,		 
16	4	413-620	BOLT Hex, 3/8"-16 x 1 1/4", G5, Full Thd,		  
17	2	87629083	U-BOLT		
18	18	86992211	NUT, LOCK 1/4, NC		 
19	4	86992215	NUT, LOCK 1/2"-13, GC, Stover		  
20	8	86992213	NUT, LOCK 3/8, NC, Stover		 
21	4	311864A1	REFLECTOR Yellow		  
22	4	311865A1	REFLECTOR Flouresent		  
23	4	311863A1	REFLECTOR Red		  
24	1	87435657	HARNESS Rear Hitch		  
	UAR	533959R1	STRAP, CABLE .135" x 11", (Not Shown)		 
	UAR	386170C1	STRAP, CABLE .30" x 27 1/2", (Not Shown)		   
	UAR	27601215	LENS Amber (Not Shown)		
	UAR	27601216	LENS Red (Not Shown)		





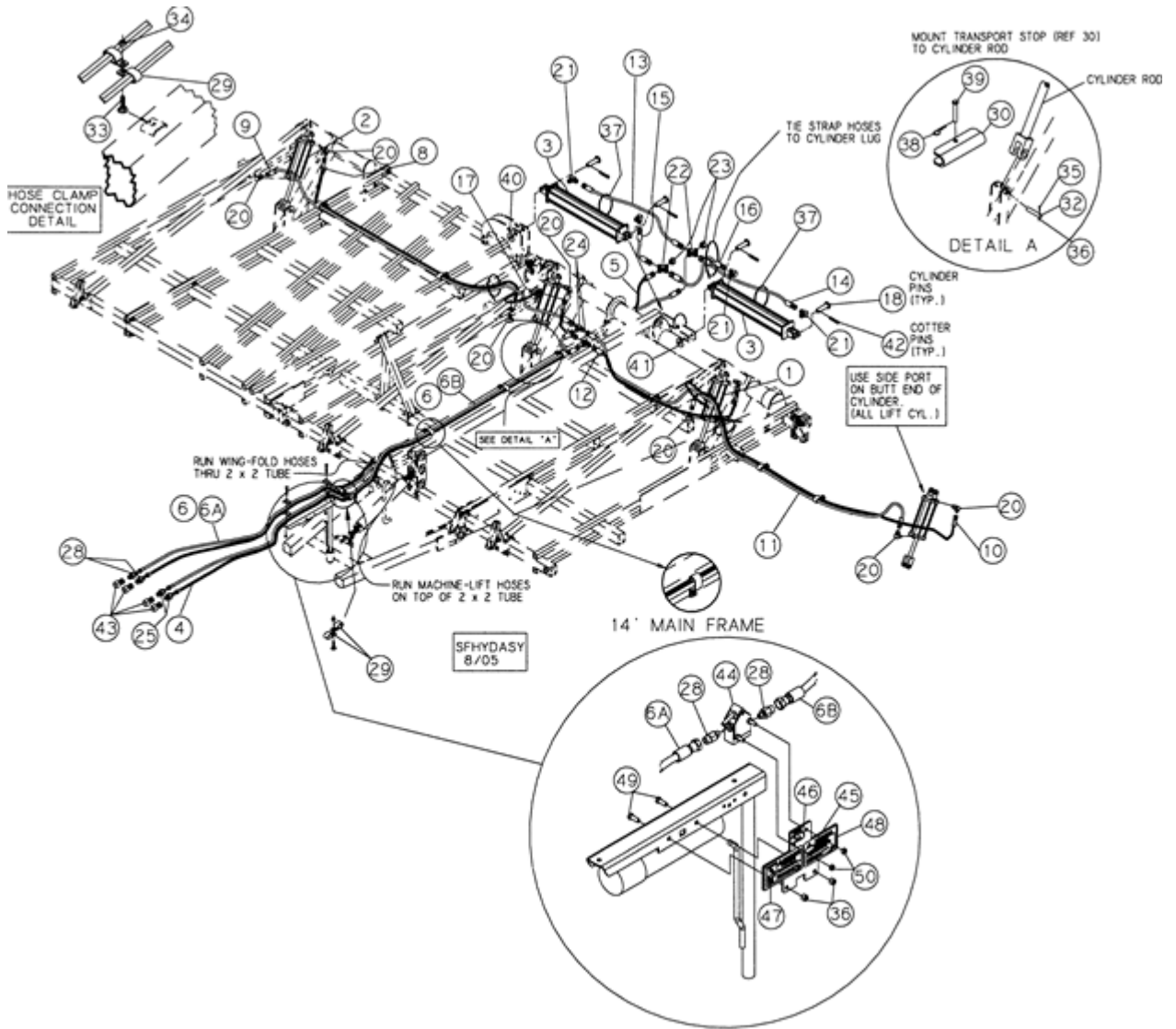

















200 : TIGER-MATE CASE IH FIELD CULTIVATOR

35.100.01 - HYDRAULICS SINGLE FOLD MODELS 12-1/2 THROUGH 38-1/2

















200 : TIGER-MATE CASE IH FIELD CULTIVATOR

35.100.01 - HYDRAULICS SINGLE FOLD MODELS 12-1/2 THROUGH 38-1/2

Ссылка	Кол-во	Номер по каталогу	Описание	ОН	Индикаторы
1	2	87423771	CYLINDER ASSY. 3-1/2 x 8, Rephase		 
2	2	87423770	HYDRAULIC CYLINDER 3-1/4 x 8, Rephase		 
3	2	25340301	CYLINDER ASSY. 4 x 30, 3000 p.s.i.		 
3	2	25340362	CYLINDER ASSY. 4 x 36, 3000 p.s.i., 34-1/2 To 38-1/2 Models		 
4	2	407167A1	HOSE ASSY. 1/4 x 175, 10 Mainframe		
4	2	1264171C1	HOSE 1/4 x 215, 12 Mainframe		
4	2	227185A1	HOSE 1/4 x 250, 14 Mainframe		
5	2	1254530C2	HOSE 1/4 x 130		
6	1	1337374C1	HOSE 1/2 x 270, 10 Mainframe		
6	1	113710A1	HOSE 1/2 x 295, 12 Mainframe		
6	1	134209A1	HOSE 1/2 x 345, 14 Mainframe		
6A	1	91202C1	HOSE 1/2 x 85, All Mainframes		 
6B	1	1337360C1	HOSE ASSY. 1/2 x 175, 10 Mainframe		
6B	1	91205C1	HOSE 1/2 x 210, 12 Mainframe		
6B	1	1978106C1	HOSE 1/2 x 240, 14 Mainframe		
8	1	25600676	HOSE ASSY. 3/8 x 88, 20-1/2 And 22-1/2 Models		
8	1	25600669	HOSE ASSY. 3/8 x 114, 24-1/2, 26-1/2, And 28-1/2 Models		
8	1	25600671	HOSE ASSY. 3/8 x 138, 30-1/2, 32-1/2, 34-1/2, And 36-1/2 Models		
8	1	25600752	HOSE ASSY. 3/8 x 161, 38-1/2 Model		
9	1	25600692	HOSE ASSY. 3/8 x 108, 20-1/2 And 22-1/2 Models		
9	1	25600684	HOSE ASSY. 3/8 x 132, 24-1/2, 26-1/2, And 28-1/2 Models		 
9	1	25600717	HOSE ASSY. 3/8 x 155, 30-1/2 And 32-1/2 Models		
9	1	25600752	HOSE ASSY. 3/8 x 161, 34-1/2 And 36-1/2 Models		
9	1	25600667	HOSE ASSY. 3/8 x 187, 38-1/2 Model		
10	1	25600724	HOSE ASSY. 3/8 x 104-1/2, 20-1/2 And 22-1/2 Models		
10	1	25600734	HOSE ASSY. 3/8 x 124-1/2, 24-1/2, 26-1/2, And 28-1/2 Models		
10	1	25600814	HOSE ASSY. 3/8 x 148, 30-1/2, 32-1/2, 34-1/2, And 36-1/2 Models		
10	1	25600615	HOSE ASSY. 3/8 x 173, 38-1/2 Model		
11	1	25600606	HOSE ASSY. 3/8 x 150, 20-1/2 And 22-1/2 Models		

























200 : TIGER-MATE CASE IH FIELD CULTIVATOR

35.100.01 - HYDRAULICS SINGLE FOLD MODELS 12-1/2 THROUGH 38-1/2

Ссылка	Кол-во	Номер по каталогу	Описание	ОН	Индикаторы
11	1	25600615	HOSE ASSY. 3/8 x 173, 24-1/2, 26-1/2, And 28-1/2 Models		
11	1	25600733	HOSE ASSY. 3/8 x 197, 30-1/2 Model With 10 Mainframe		
11	1	25600718	HOSE ASSY. 3/8 x 215, 30-1/2 And 32-1/2 Models With 12 Mainframe		
11	1	25600759	HOSE ASSY. 3/8 x 245, 34-1/2 And 36-1/2 Models		
11	1	25600760	HOSE ASSY. 3/8 x 269, 38-1/2 Model		
12	1	25600678	HOSE ASSY. 3/8 x 78, 10-1/2 Mainframe		
12	1	25600704	HOSE ASSY. 3/8 x 97, 12-1/2 Mainframe		
12	1	25600681	HOSE ASSY. 3/8 x 121, 14-1/2 Mainframe		 
13	1	25600429	HOSE ASSY. 1/4 x 26, 10-1/2 Mainframe		
13	1	25600422	HOSE ASSY. 1/4 x 30, 12-1/2 Mainframe		
13	1	25600434	HOSE ASSY. 1/4 x 34, 14-1/2 Mainframe		
14	1	147878C1	HOSE 1/4 x 65, 10-1/2 Mainframe		
14	1	25600436	HOSE ASSY. 1/4 x 84, 12-1/2 Mainframe		
14	1	1284366C1	HOSE 1/4 x 100, 14-1/2 Mainframe		
15	1	25600429	HOSE ASSY. 1/4 x 26, 10-1/2 Mainframe		
15	1	25600438	HOSE ASSY. 1/4 x 16, 12-1/2 Mainframe		
15	1	1284278C1	HOSE 1/4 x 41, 14-1/2 Mainframe		
16	1	25600422	HOSE ASSY. 1/4 x 30, 10-1/2 Mainframe		
16	1	25600437	HOSE ASSY. 1/4 x 48, 12-1/2 Mainframe		
16	1	1277717C1	HOSE 1/4 x 60, 14-1/2 Mainframe		
17	1	25600713	HOSE ASSY. 3/8 x 27-1/2, 10-1/2 Mainframe		
17	1	25600738	HOSE ASSY. 3/8 x 33-1/2, 12-1/2 Mainframe		
17	1	25600614	HOSE ASSY. 3/8 x 36, 14-1/2 Mainframe		
18	4	14891660	PIN, SPECIAL 1 x 4.30		
20	8	218-5106	ELBOW 90°, 3/4"-16, 37° x 3/4"-16, O-Ring,		  
21	4	218-5128	ELBOW 90°, 9/16"-18, 37° x 3/4"-16, O-Ring,		 

200 : TIGER-MATE CASE IH FIELD CULTIVATOR

35.100.01 - HYDRAULICS SINGLE FOLD MODELS 12-1/2 THROUGH 38-1/2





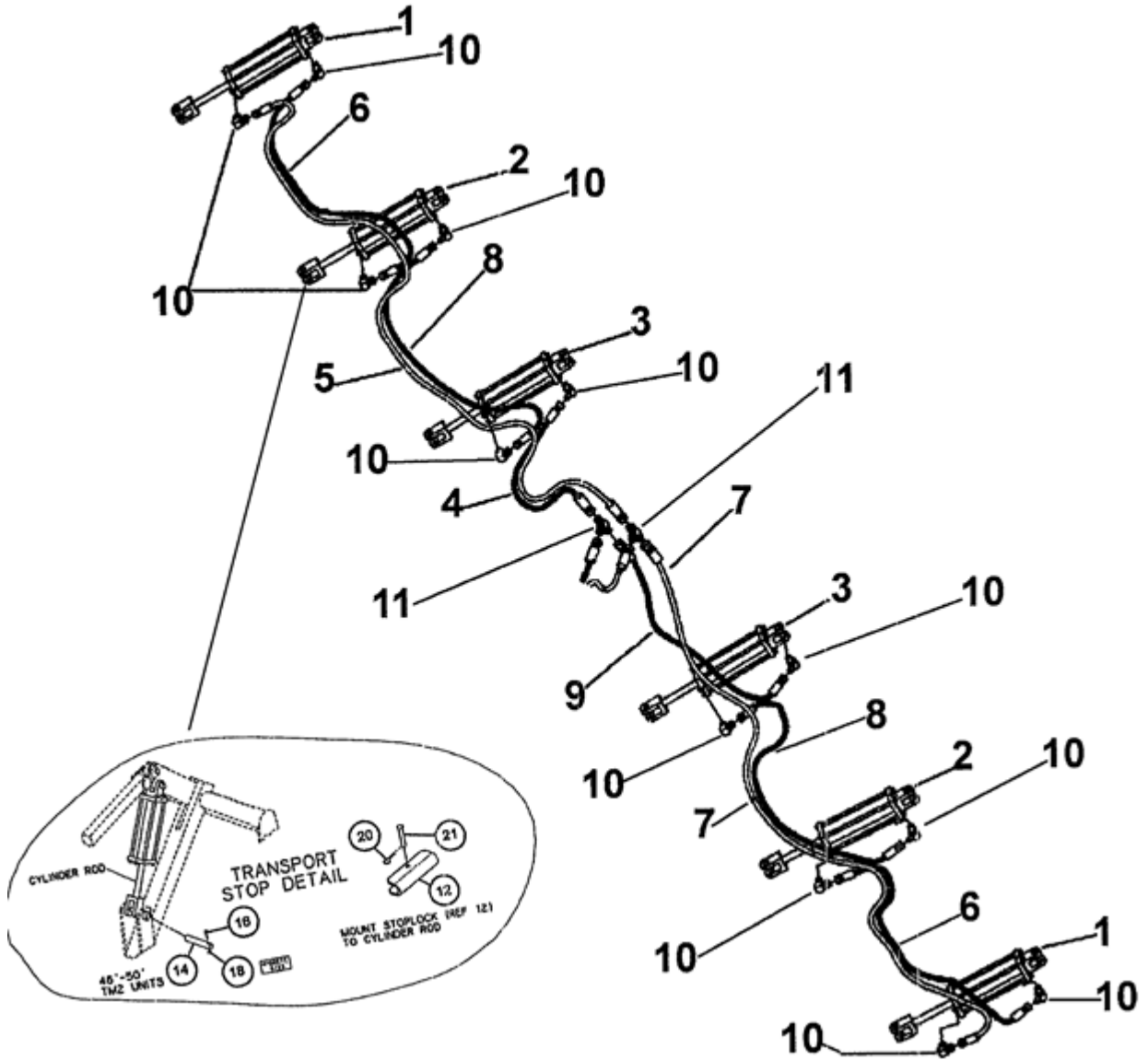













Ссылка	Кол-во	Номер по каталогу	Описание	ОН	Индикаторы
22	2	218-653	CONNECTION, 4 WAY 9/16"-18, 37°		
23	2	218-754	CAP 37°, 9/16"-18,		 
24	2	218-594	TEE 3/4"-16, 37°		
25	2	218-5058	CONNECTOR, HYD. 9/16"-18, 37° x 3/4"-18, O-Ring,		 
28	4	218-5059	CONNECTOR, HYD. 3/4"-16, 37° x 3/4"-16, O-Ring,		 
29	UAR	22510700	CLAMP, HOSE 5/8		
29	UAR	22510710	CLAMP, HOSE 3/4		
30	2	87404919	STOP 12, Transport		
32	4	14891630	PIN, SPECIAL 1 x 5.75		
33	UAR	433-616	BOLT, CARRIAGE Short NK, 3/8"-16 x 1", G5,		
35	2	413-640	BOLT Hex, 3/8"-16 x 2 1/2", G5,		 
36	UAR	86992213	NUT, LOCK 3/8, NC, Stover		 
37	UAR	289862C1	STRAP, CABLE 3/16" x 7",		 
38	2	14720411	PIN, SPLIT (COTTER) 1/8 x 2, Hairpin		 
39	2	14810251	PIN, HEADED 5/8 x 3		 
40	2	495-21106	WASHER 1", Standard		
41	2	17616011	BUSHING, LARGE 1, Machine, 10 ga		
42	UAR	432-1632	PIN, SPLIT (COTTER) 1/4" x 2",		 
43	4	25705041	COUPLING ISO, 3/4 SAEF		
44	1	87328528	VALVE, SHUT-OFF Hydraulic Shut Off		
45	1	87328931	PLATE Bracket		
46	1	87343258	DECAL Hydraulic Transport Operation		
47	1	87353780	DECAL Warning Crushing Hazard		
48	1	87353782	DECAL Transport Hazard		
49	2	413-616	BOLT Hex, 3/8"-16 x 1", G5, Full Thd,		 
50	2	86992212	NUT, LOCK 5/16 Hex, Stover		

200 : TIGER-MATE CASE IH FIELD CULTIVATOR
 35.100.02 - TRANSPORT HYDRAULICS 38-1/2 THROUGH 50-1/2 MODELS











200 : TIGER-MATE CASE IH FIELD CULTIVATOR

35.100.02 - TRANSPORT HYDRAULICS 38-1/2 THROUGH 50-1/2 MODELS

Ссылка	Кол-во	Номер по каталогу	Описание	ОН	Индикаторы
1	2	87423768	HYDRAULIC CYLINDER 3 x 8, Rephase, 38-1/2 To 48-1/2 Models		 
1	2	87423766	CYLINDER 3-3/4 x 8, 50 Foot Models		 
2	2	87423770	HYDRAULIC CYLINDER 3-1/4 x 8, Rephase, 38-1/2 To 50-1/2 Models		 
3	2	87423771	CYLINDER ASSY. 3-1/2 x 8, Rephase, 38-1/2 To 50-1/2 Models		 
4	1	25600758	HOSE ASSY. 3/8 x 39, 38 To 44 Models		
4	1	25600614	HOSE ASSY. 3/8 x 36, 46 To 48 Models		
5	1	25600761	HOSE ASSY. 3/8 x 218, 38 To 40 Models		
5	1	25600756	HOSE ASSY. 3/8 x 242, 42 To 46 Models		
5	1	25600750	HOSE ASSY. 3/8 x 263, 48 To 50 Models		
6	2	25600711	HOSE ASSY. 3/8 x 93, 38 To 46 Models		
6	2	25600727	HOSE ASSY. 3/8 x 116-1/2, 48 To 50 Models		
7	1	25600653	HOSE ASSY. 3/8 x 294, 38 To 40 Models		
7	1	25600737	HOSE ASSY. 3/8 x 300, 42 To 46 Models		
7	1	25600725	HOSE ASSY. 3/8 x 335, 48 To 50 Models		
8	2	25600734	HOSE ASSY. 3/8 x 124-1/2, 38 To 40 Models		
8	2	25600716	HOSE ASSY. 3/8 x 139-1/2, 42 To 46 Models		
8	2	25600814	HOSE ASSY. 3/8 x 148, 48 To 50 Models		
9	1	25600720	HOSE ASSY. 3/8 x 90, 38 To 44 Models		
9	1	25600691	HOSE ASSY. 3/8 x 99, 46 To 50 Models		
10	12	218-5106	ELBOW 90°, 3/4"-16, 37° x 3/4"-16, O-Ring,		  
11	2	218-594	TEE 3/4"-16, 37°,		
12	1	87404919	STOP 12, Transport		
14A	2	14891623	PIN, SPECIAL 1 x 5.50, 12 Mainframe Only		
14B	6	14891630	PIN, SPECIAL 1 x 5.75, 14 Mainframe And Wings		
16	6	413-840	BOLT Hex, 1/2"-13 x 2 1/2", G5,		

200 : TIGER-MATE CASE IH FIELD CULTIVATOR

35.100.02 - TRANSPORT HYDRAULICS 38-1/2 THROUGH 50-1/2 MODELS





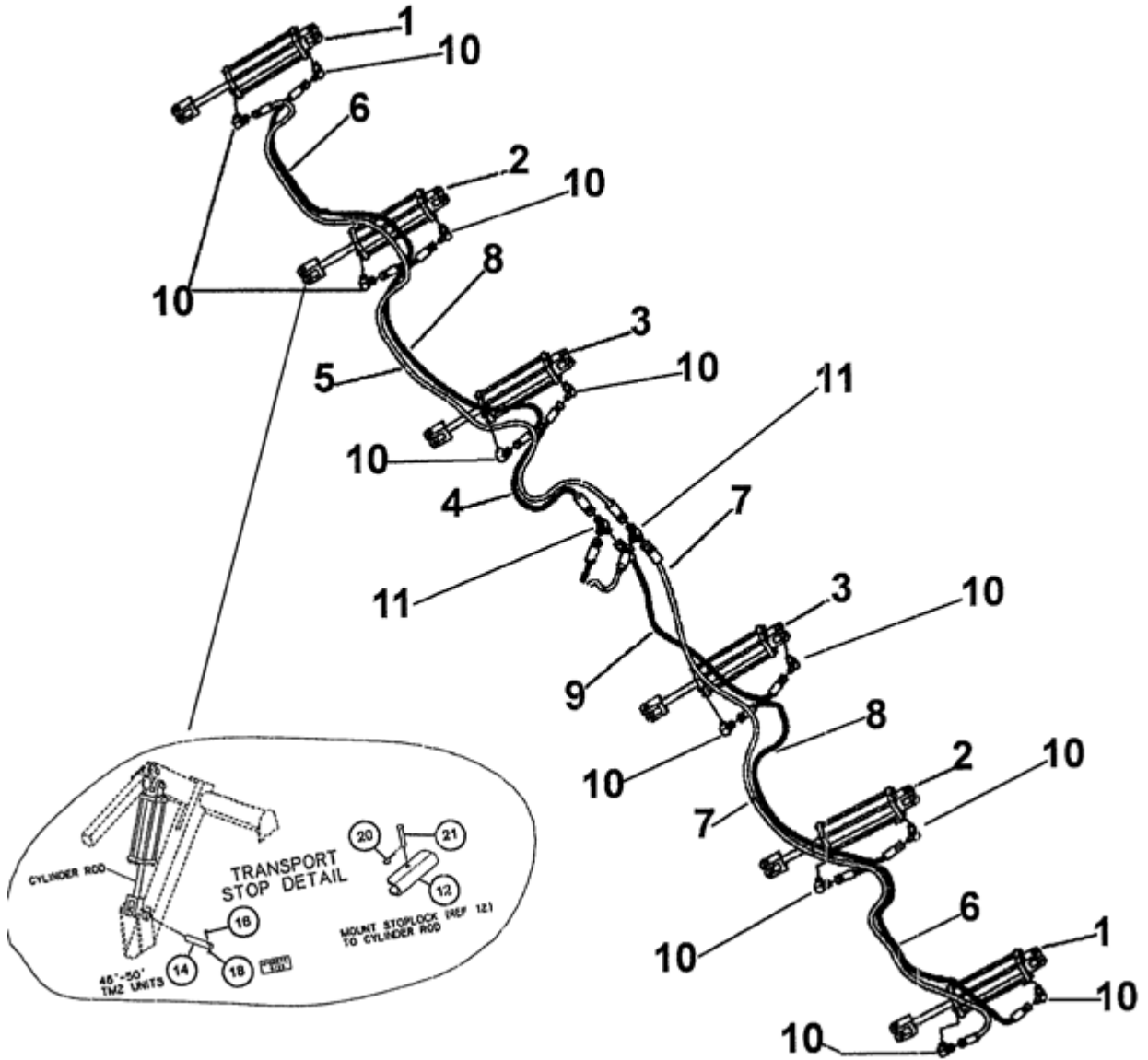























Ссылка	Кол-во	Номер по каталогу	Описание	ОН	Индикаторы
18	6	86992213	NUT, LOCK 3/8, NC, Stover		 
19	2	83918746	WASHER 5/16", .354" x .688" x .08" Thk,		 
20	1	14810251	PIN, HEADED 5/8 x 3-1/4		 
21	1	14720411	PIN, SPLIT (COTTER) 1/8 x 2, Hair		 

200 : TIGER-MATE CASE IH FIELD CULTIVATOR
 35.100.03 - TRANSPORT HYDRAULICS 54-1/2 THROUGH 60-1/2 MODELS



200 : TIGER-MATE CASE IH FIELD CULTIVATOR

35.100.03 - TRANSPORT HYDRAULICS 54-1/2 THROUGH 60-1/2 MODELS

Ссылка	Кол-во	Номер по каталогу	Описание	ОН	Индикаторы
1	2	87423770	HYDRAULIC CYLINDER 3-1/4 x 8, Rephase, 54-1/2 Models		 
1	2	87423771	CYLINDER ASSY. 3-1/2 x 8, Rephase, 58-1/2 - 60-1/2 Models		 
2	2	87423771	CYLINDER ASSY. 3-1/2 x 8, Rephase, 54-1/2 Models		 
2	2	87423766	CYLINDER 3-3/4 x 8, Rephase. 58-1/2 - 60-1/2 Models		 
3	2	87423766	CYLINDER 3-3/4 x 8, Rephase, 54-1/2 Models		 
3	2	87423777	HYDRAULIC CYLINDER 4 x 8, Rephase, 58-1/2 - 60-1/2 Models		
4	1	25600630	HOSE ASSY. 3/8 x 30		
5	1	25600609	HOSE ASSY. 3/8 x 311		
6	1	25600669	HOSE ASSY. 3/8 x 114-1/2, 54 Model Only		
6	1	25600709	HOSE ASSY. 3/8 x 141, 58 To 60 Model		
7	1	25600610	HOSE ASSY. 3/8 x 359, 54 Model Only		
7	1	25600611	HOSE ASSY. 3/8 x 383, 58 To 60 Model		
8	1	25600615	HOSE ASSY. 3/8 x 173		
9	1	25600669	HOSE ASSY. 3/8 x 114		
10	12	218-5106	ELBOW 90°, 3/4"-16, 37° x 3/4"-16, O-Ring,		  
11	2	218-594	TEE 3/4"-16, 37°,		
12	1	87404919	STOP 12, Transport		
14	6	14891630	PIN, SPECIAL 1 x 5.75		
16	6	413-640	BOLT Hex, 3/8"-16 x 2 1/2", G5,		 
18	6	86992213	NUT, LOCK 3/8, NC, Stover		 
19	1	87437414	HOSE ASSY. 3/8 x 178		
20	1	14720411	PIN, SPLIT (COTTER) 1/8 x 2, Hair		 
21	1	14810251	PIN, HEADED 5/8 x 3-1/4		 
22	1	25600681	HOSE ASSY. 3/8 x 121 (54-1/2 Model), Not Shown		 
22	1	25600814	HOSE ASSY. 3/8 x 148 (58-1/2 - 60-1/2) Model, Not Shown		





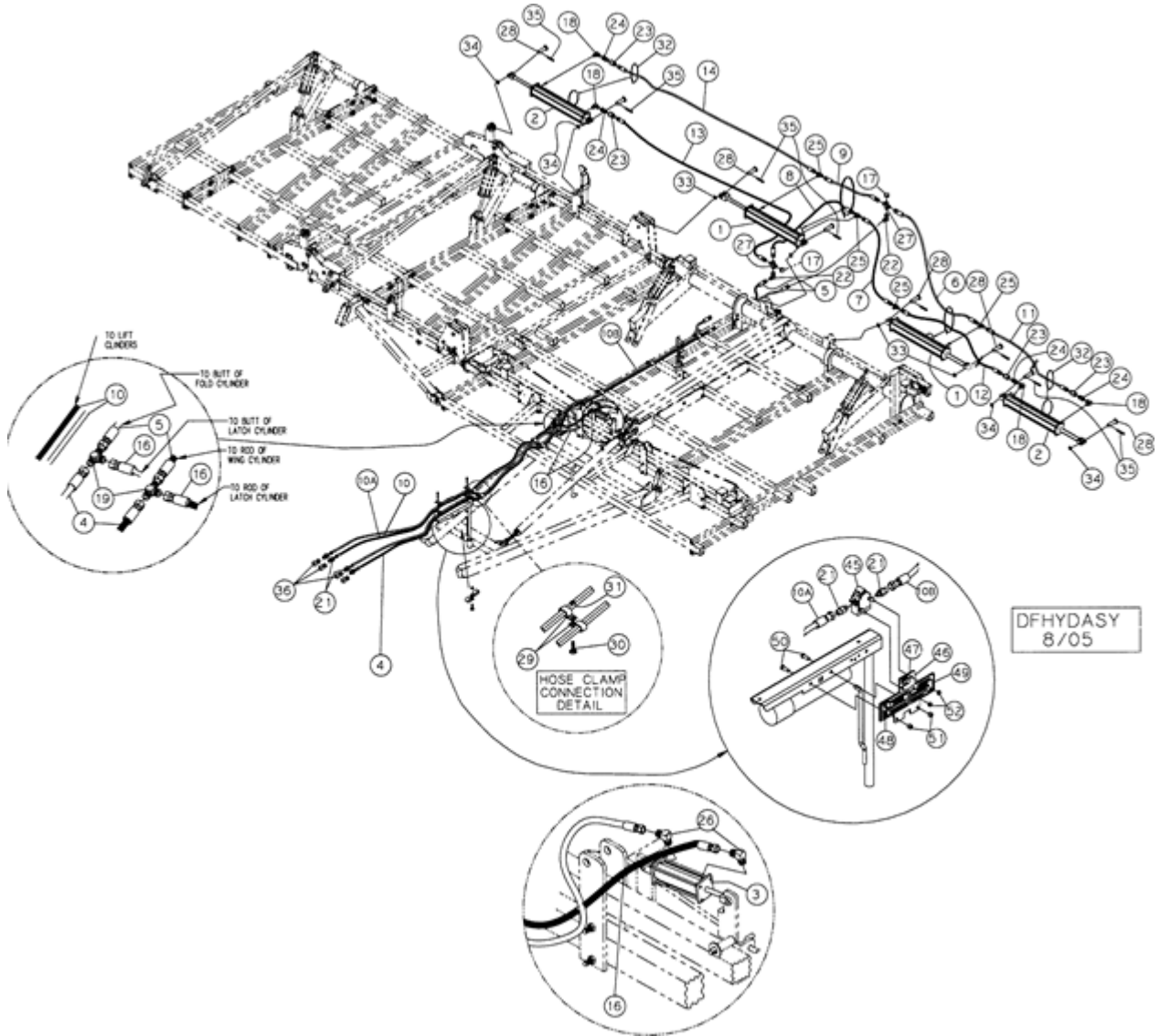





































200 : TIGER-MATE CASE IH FIELD CULTIVATOR

35.100.04 - DOUBLE FOLD WING LIFT HYDRAULICS 38-1/2 THROUGH 46-1/2





















200 : TIGER-MATE CASE IH FIELD CULTIVATOR

35.100.04 - DOUBLE FOLD WING LIFT HYDRAULICS 38-1/2 THROUGH 46-1/2

Ссылка	Кол-во	Номер по каталогу	Описание	ОН	Индикаторы
1	2	25340362	CYLINDER ASSY. 4 x 36, 3000 p.s.i.		 
2	2	25340242	CYLINDER ASSY. 4 x 24, 3000 p.s.i.		 
3	1	25320040	CYLINDER ASSY. 2 x 4, 3000 p.s.i.		 
4	2	25600747	HOSE ASSY. 3/8 x 212		
5	2	25600726	HOSE ASSY. 3/8 x 130-1/2		
6	1	25600739	HOSE ASSY. 3/8 x 86-1/2		
7	1	25600721	HOSE ASSY. 3/8 x 32		
8	1	25600622	HOSE ASSY. 3/8 x 22		
9	1	25600713	HOSE ASSY. 3/8 x 27-1/2		
10	1	113710A1	HOSE 1/2 x 295		
10A	1	91202C1	HOSE 1/2 x 85, 12 Mainframe		 
10B	1	91205C1	HOSE 1/2 x 210, 12 Mainframe		
11	1	25600711	HOSE ASSY. 3/8 x 93, 38-1/2 To 40-1/2 Models		
11	1	25600681	HOSE ASSY. 3/8 x 121, 42-1/2 To 46-1/2 Models		 
12	1	25600724	HOSE ASSY. 3/8 x 104-1/2, 38-1/2 To 40-1/2 Models		
12	1	25600684	HOSE ASSY. 3/8 x 132, 42-1/2 To 46-1/2 Models		 
13	1	25600711	HOSE ASSY. 3/8 x 93, 38-1/2 To 40-1/2 Models		
13	1	25600650	HOSE ASSY. 3/8 x 128, 42-1/2 To 46-1/2 Models		 
14	1	25600720	HOSE ASSY. 3/8 x 90, 38-1/2 To 40-1/2 Models		
14	1	25600681	HOSE ASSY. 3/8 x 121, 42-1/2 To 46-1/2 Models		 
16	2	25600614	HOSE ASSY. 3/8 x 36		
17	2	218-755	CAP 37°, 3/4"-16,		 
18	4	218-5106	ELBOW 90°, 3/4"-16, 37° x 3/4"-16, O-Ring,		   
19	2	218-594	TEE 3/4"-16, 37°,		 
21	6	218-5059	CONNECTOR, HYD. 3/4"-16, 37° x 3/4"-16, O-Ring,		  
22	2	218-5230	ELBOW 90°, 3/4"-16, 37° x 3/4"-16, 37° Fem Sw,		  
23	4	25405013	VALVE, CONTROL Throttle, Purple		
24	4	25707534	ADAPTER 3/4 SAEM x 3/4 JICF		
25	4	218-5183	TEE 3/4"-16, 37° x 3/4"-16, O-Ring Br,		  
26	2	218-5280	ELBOW 90°, 3/4"-16, 37° x 9/16"-18, O-Ring,		 
27	2	218-654	CONNECTION, 4 WAY 3/4"-16, 37°,		 
28	8	14891660	PIN, SPECIAL 1 x 4.30		
29	UAR	22510700	CLAMP, HOSE 5/8		

200 : TIGER-MATE CASE IH FIELD CULTIVATOR

35.100.04 - DOUBLE FOLD WING LIFT HYDRAULICS 38-1/2 THROUGH 46-1/2

Ссылка	Кол-во	Номер по каталогу	Описание	ОН	Индикаторы
29	UAR	22510710	CLAMP, HOSE 3/4		
30	UAR	413-616	BOLT Hex, 3/8"-16 x 1", G5, Full Thd,		  
31	UAR	86992213	NUT, LOCK 3/8, NC, Stover		 
32	UAR	289862C1	STRAP, CABLE 3/16" x 7",		 
33	2	87374	WASHER 1", Standard, Flat		 
34	6	17616011	BUSHING, LARGE 1, Machine, 10 ga		
35	UAR	432-1632	PIN, SPLIT (COTTER) 1/4" x 2",		 
36	4	25705041	COUPLING Male ISO, 3/4 SAEF		
45	1	87328528	VALVE, SHUT-OFF Hydraulic Shut Off		
46	1	87328931	PLATE Plate		
47	1	87343258	DECAL Hydraulic Transport Operation		
48	1	87353780	DECAL Warning Crushing Hazard		
49	1	87353782	DECAL Transport Hazard		
50	2	413-616	BOLT Hex, 3/8"-16 x 1", G5, Full Thd,		  
51	2	86992213	NUT, LOCK 3/8, Hex, Stover		 
52	2	86992212	NUT, LOCK 5/16, Hex, Stover		





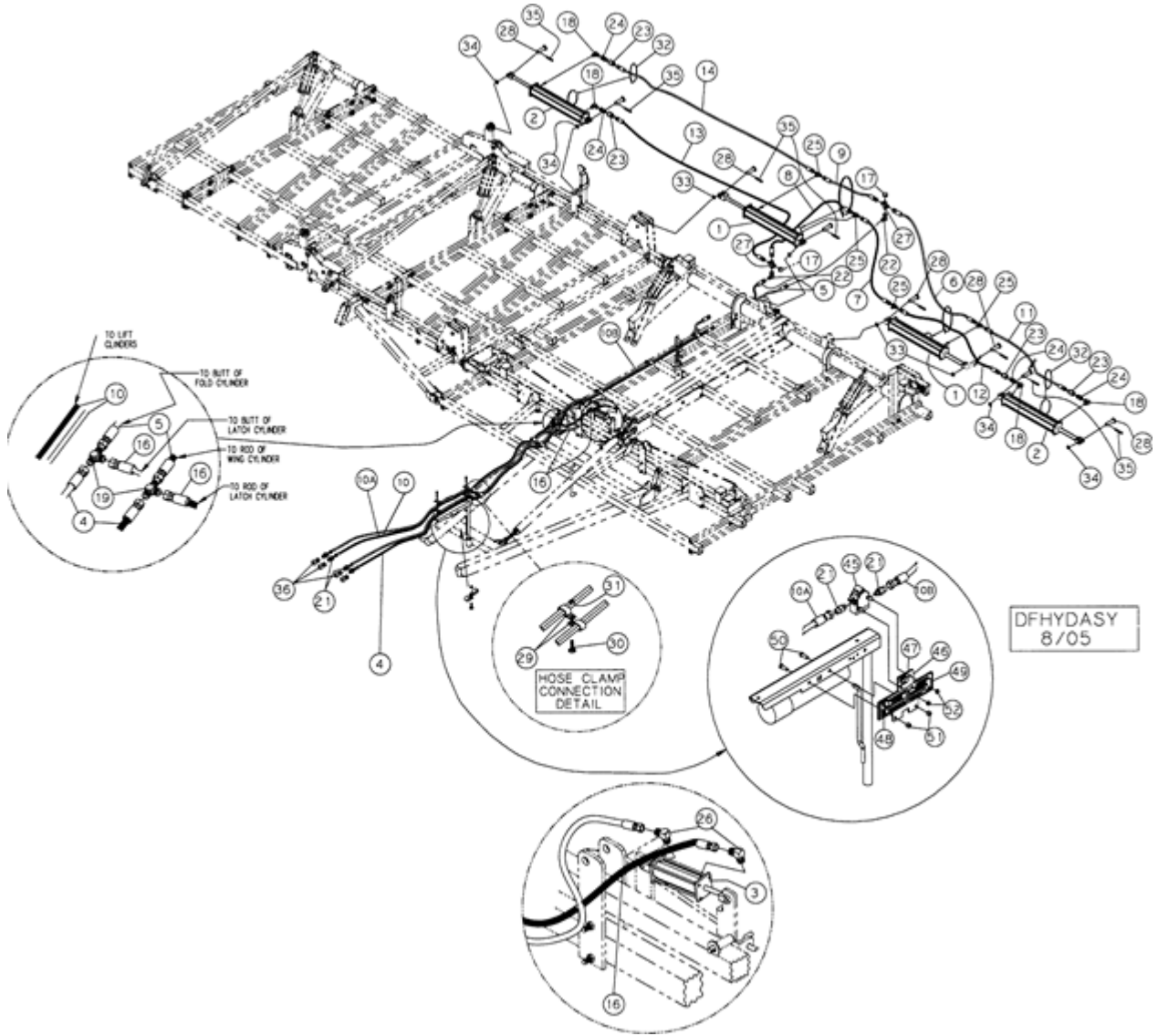



















































200 : TIGER-MATE CASE IH FIELD CULTIVATOR

35.100.05 - DOUBLE FOLD WING LIFT HYDRAULICS 46-1/2 THROUGH 50-1/2



200 : TIGER-MATE CASE IH FIELD CULTIVATOR

35.100.05 - DOUBLE FOLD WING LIFT HYDRAULICS 46-1/2 THROUGH 50-1/2

Ссылка	Кол-во	Номер по каталогу	Описание	ОН	Индикаторы
1	2	25340362	CYLINDER ASSY. 4 x 36, 3000 p.s.i.		 
2	2	25340242	CYLINDER ASSY. 4 x 24, 3000 p.s.i.		 
3	1	25320040	CYLINDER ASSY. 2 x 4, 3000 p.s.i.		 
4	2	25600707	HOSE ASSY. 3/8 x 246		
5	2	25600726	HOSE ASSY. 3/8 x 130-1/2		
6	1	25600724	HOSE ASSY. 3/8 x 104-1/2		
7	1	25600708	HOSE ASSY. 3/8 x 50		
8	1	25600613	HOSE ASSY. 3/8 x 12		
9	1	25600738	HOSE ASSY. 3/8 x 33-1/2		
10	1	134209A1	HOSE 1/2 x 345		
10A	1	91202C1	HOSE 1/2 x 85		 
10B	1	1978106C1	HOSE 1/2 x 240		
11	1	25600681	HOSE ASSY. 3/8 x 121		 
12	1	25600684	HOSE ASSY. 3/8 x 132		 
13	1	25600650	HOSE ASSY. 3/8 x 128		 
14	1	25600681	HOSE ASSY. 3/8 x 121		 
16	2	25600614	HOSE ASSY. 3/8 x 36		
17	2	218-755	CAP 37°, 3/4"-16,		 
18	4	218-5106	ELBOW 90°, 3/4"-16, 37° x 3/4"-16, O-Ring,		   
19	2	218-594	TEE 3/4"-16, 37°,		 
21	6	218-5059	CONNECTOR, HYD. 3/4"-16, 37° x 3/4"-16, O-Ring,		  
22	2	218-5230	ELBOW 90°, 3/4"-16, 37° x 3/4"-16, 37° Fem Sw,		  
23	4	25405013	VALVE, CONTROL Throttle, Purple		
24	4	25707534	ADAPTER 3/4 SAEM x 3/4 JICF		
25	4	218-5183	TEE 3/4"-16, 37° x 3/4"-16, O-Ring Br,		  
26	2	218-5280	ELBOW 90°, 3/4"-16, 37° x 9/16"-18, O-Ring,		  
27	2	218-654	CONNECTION, 4 WAY 3/4"-16, 37°,		 
28	8	14891660	PIN, SPECIAL 1 x 4.30		
29	UAR	22510700	CLAMP, HOSE 5/8		
29	UAR	22510710	CLAMP, HOSE 3/4		
30	UAR	413-616	BOLT Hex, 3/8"-16 x 1", G5, Full Thd,		   
31	UAR	86992213	NUT, LOCK 3/8, NC, Stover		 
32	UAR	289862C1	STRAP, CABLE 3/16" x 7",		  
33	2	495-21106	WASHER 1", Standard, Flat		 
34	6	17616011	BUSHING, LARGE 1, Machine, 10 ga		
35	UAR	432-1632	PIN, SPLIT (COTTER) 1/4" x 2",		  
36	4	25705041	COUPLING Male, ISO, 3/4 SAEF		





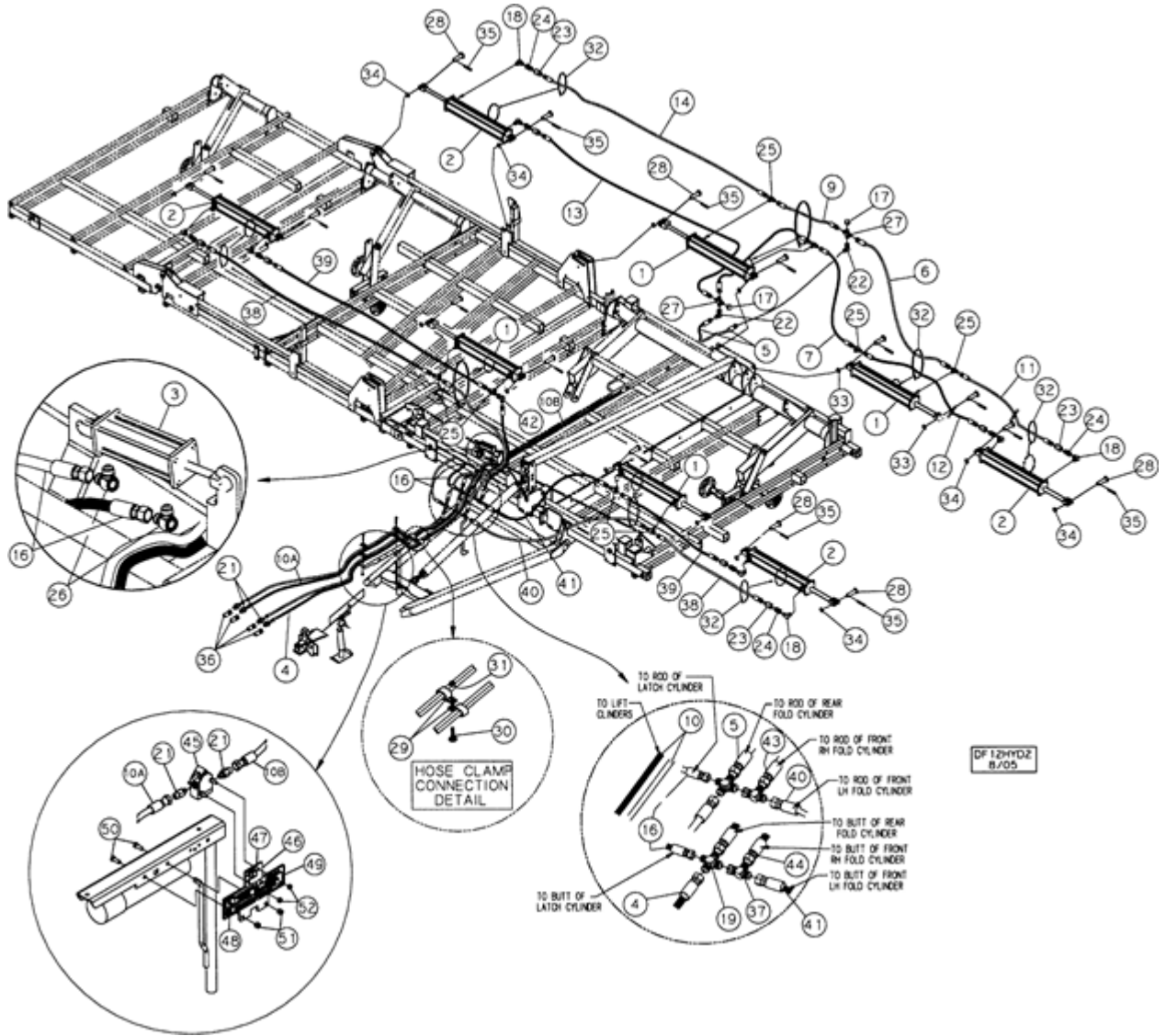





































200 : TIGER-MATE CASE IH FIELD CULTIVATOR

35.100.06 - FRONT WING LIFT HYDRAULICS OPTION 38-1/2 THROUGH 46-1/2



200 : TIGER-MATE CASE IH FIELD CULTIVATOR

35.100.06 - FRONT WING LIFT HYDRAULICS OPTION 38-1/2 THROUGH 46-1/2

Ссылка	Кол-во	Номер по каталогу	Описание	ОН	Индикаторы
1	2	25340362	CYLINDER ASSY. 4 x 36, 3000 psi., Rear Inner Wing		 
1	2	25330360	CYLINDER ASSY. 3 x 36, 3000 psi, Optional Front Inner Wing		
2	2	25340242	CYLINDER ASSY. 4 x 24, 3000 psi, Rear Outer Wing		 
2	2	25330241	CYLINDER ASSY. 3 x 24, 3000 psi, Optional Front Outer Wing		 
3	1	25320040	CYLINDER ASSY. 2 x 4, 3000 psi		 
4	2	25600747	HOSE ASSY. 3/8 x 212		
5	2	25600726	HOSE ASSY. 3/8 x 130-1/2		
6	1	25600739	HOSE ASSY. 3/8 x 86-1/2		
7	1	25600721	HOSE ASSY. 3/8 x 32		
8	1	25600622	HOSE ASSY. 3/8 x 22		
9	1	25600713	HOSE ASSY. 3/8 x 27-1/2		
10	1	113710A1	HOSE 1/2 x 295		
10A	1	91202C1	HOSE 1/2 x 85, 12 Mainframe		 
10B	1	91205C1	HOSE 1/2 x 210, 12 Mainframe		
11	1	25600711	HOSE ASSY. 3/8 x 93, 38-1/2 To 40-1/2 Models		
11	1	25600681	HOSE ASSY. 3/8 x 121, 42-1/2 To 46-1/2 Models		 
12	1	25600724	HOSE ASSY. 3/8 x 104-1/2, 38-1/2 To 40-1/2 Models		
12	1	25600684	HOSE ASSY. 3/8 x 132, 42-1/2 To 46-1/2 Models		 
13	1	25600711	HOSE ASSY. 3/8 x 93, 38-1/2 To 40-1/2 Models		
13	1	25600650	HOSE ASSY. 3/8 x 128, 42-12/ To 46-1/2 Models		 
14	1	25600720	HOSE ASSY. 3/8 x 90, 38-1/2 To 40-1/2 Models		
14	1	25600681	HOSE ASSY. 3/8 x 121, 42-1/2 To 46-1/2 Models		 
16	2	25600614	HOSE ASSY. 3/8 x 36		
17	2	218-755	CAP 37°, 3/4"-16,		 
18	10	218-5106	ELBOW 90°, 3/4"-16, 37° x 3/4"-16, O-Ring,		   
19	2	218-654	CONNECTION, 4 WAY 3/4"-16, 37°,		 
21	4	218-5059	CONNECTOR, HYD. 3/4"-16, 37° x 3/4"-16, O-Ring,		  
22	2	218-5230	ELBOW 90°, 3/4"-16, 37° x 3/4"-16, 37° Fem Sw,		  
23	8	25405013	VALVE, CONTROL Throttle, Purple		
24	8	25707534	ADAPTER 3/4 SAEM x 3/4 JICF		
25	8	218-5183	TEE 3/4"-16, 37° x 3/4"-16, O-Ring Br,		  
26	2	218-5280	ELBOW 90°, 3/4"-16, 37° x 9/16"-18, O-Ring,		 

200 : TIGER-MATE CASE IH FIELD CULTIVATOR

35.100.06 - FRONT WING LIFT HYDRAULICS OPTION 38-1/2 THROUGH 46-1/2

Ссылка	Кол-во	Номер по каталогу	Описание	ОН	Индикаторы
27	2	218-654	CONNECTION, 4 WAY 3/4"-16, 37°,		
28	8	14891660	PIN, SPECIAL 1 x 4.30		
29	UAR	22510700	CLAMP, HOSE 5/8		
29	UAR	22510710	CLAMP, HOSE 3/4		
30	UAR	433-616	BOLT, CARRIAGE Short NK, 3/8"-16 x 1", G5,		
31	UAR	86992213	NUT, LOCK 3/8, NC, Stover		
32	UAR	289862C1	STRAP, CABLE 3/16" x 7",		
33	4	495-21106	WASHER 1", Standard, Flat		
34	12	87374	WASHER 1", Machine, 10 ga		
35	UAR	432-1632	PIN, SPLIT (COTTER) 1/4" x 2",		
36	4	25705041	COUPLING Male, ISO, 3/4 SAEF		
37	2	218-845	TEE 37°, 3/4"-16 x 3/4"-16, Fem Sw Run, Tube, Slide Swivel		
38	2	25600711	HOSE ASSY. 3/8 x 93, 38-1/2 To 40-1/2 Models		
38	2	25600681	HOSE ASSY. 3/8 x 121, 42-1/2 To 46-1/2 Models		
39	2	25600711	HOSE ASSY. 3/8 x 93, 38-1/2 To 40-1/2 Models		
39	2	25600681	HOSE ASSY. 3/8 x 121, 42-1/2 To 46-1/2 Models		
40	1	25600735	HOSE ASSY. 3/8 x 82		
41	1	25600758	HOSE ASSY. 3/8 x 39		
42	1	218-5230	ELBOW 90°, 3/4"-16, 37° x 3/4"-16, 37° Fem Sw,		
43	1	25600614	HOSE ASSY. 3/8 x 36		
44	1	25600618	HOSE ASSY. 3/8 x 18		
45	1	87328528	VALVE, SHUT-OFF Hydraulic Shut Off		
46	1	87328931	PLATE Plate		
47	1	87343258	DECAL Hydraulic Transport Operation		
48	1	87353780	DECAL Warning Crushing Hazard		
49	1	87353782	DECAL Transport Hazard		
50	2	413-616	BOLT Hex, 3/8"-16 x 1", G5, Full Thd,		
51	2	86992213	NUT, LOCK 3/8, Hex, Stover		
52	2	86992212	NUT, LOCK 5/16 , Hex, Stover		





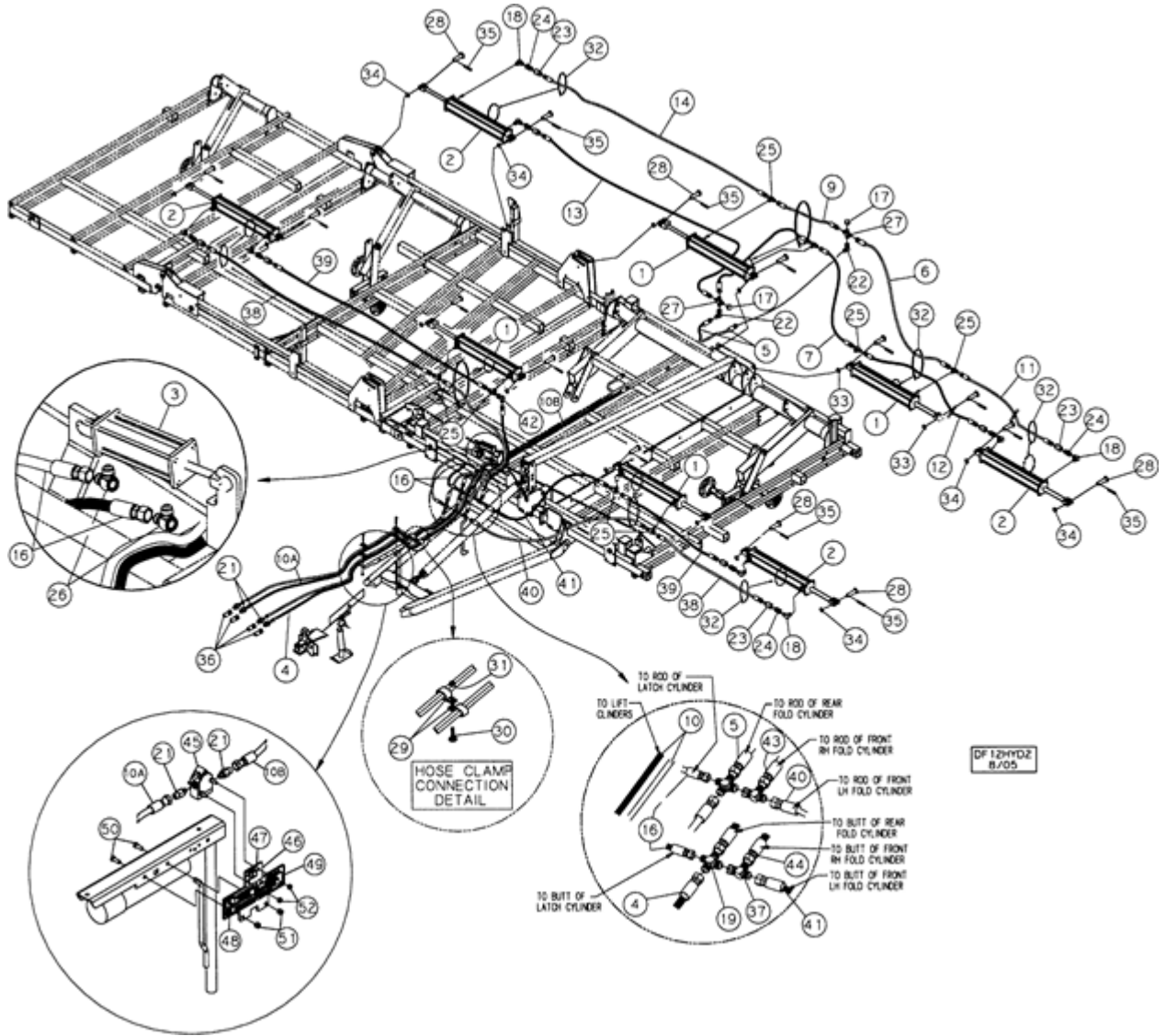













































200 : TIGER-MATE CASE IH FIELD CULTIVATOR

35.100.07 - FRONT WING LIFT HYDRAULICS OPTION 46-1/2 THROUGH 50-1/2



200 : TIGER-MATE CASE IH FIELD CULTIVATOR

35.100.07 - FRONT WING LIFT HYDRAULICS OPTION 46-1/2 THROUGH 50-1/2

Ссылка	Кол-во	Номер по каталогу	Описание	ОН	Индикаторы
1	2	25340362	CYLINDER ASSY. 4 x 36, 3000 psi, Rear Inner Wing		 
1	2	25335361	CYLINDER ASSY. 3-1/2 x 36, 3000 psi, Optional Front Inner Wing		 
2	2	25340242	CYLINDER ASSY. 4 x 24, 3000 psi, Rear Outer Wing		 
2	2	25335242	CYLINDER ASSY. 3-1/2 x 24, 3000 psi, Optional Front Outer Wing		 
3	1	25320040	CYLINDER ASSY. 2 x 4, 3000 psi		 
4	2	25600707	HOSE ASSY. 3/8 x 246		
5	2	25600726	HOSE ASSY. 3/8 x 130-1/2		
6	1	25600724	HOSE ASSY. 3/8 x 104-1/2		
7	1	25600708	HOSE ASSY. 3/8 x 50		
8	1	25600613	HOSE ASSY. 3/8 x 12		
9	1	25600738	HOSE ASSY. 3/8 x 33-1/2		
10	1	134209A1	HOSE 1/2 x 345		
10A	1	91202C1	HOSE 1/2 x 85		 
10B	1	1978106C1	HOSE 1/2 x 240		
11	1	25600681	HOSE ASSY. 3/8 x 121		 
12	1	25600684	HOSE ASSY. 3/8 x 132		 
13	1	25600650	HOSE ASSY. 3/8 x 128		 
14	1	25600681	HOSE ASSY. 3/8 x 121		 
15	2	25600841	HOSE ASSY. 1/2 x 246		
16	2	25600614	HOSE ASSY. 3/8 x 36		
17	2	218-755	CAP 37°, 3/4"-16,		 
18	8	218-5106	ELBOW 90°, 3/4"-16, 37° x 3/4"-16, O-Ring,		   
19	2	218-594	TEE 3/4"-16, 37°,		 
21	6	218-5059	CONNECTOR, HYD. 3/4"-16, 37° x 3/4"-16, O-Ring,		  
22	2	218-5230	ELBOW 90°, 3/4"-16, 37° x 3/4"-16, 37° Fem Sw,		  
23	8	25405013	VALVE, CONTROL Throttle, Purple		
24	8	25707534	ADAPTER 3/4 SAEM x 3/4 JICF		
25	8	218-5183	TEE 3/4"-16, 37° x 3/4"-16, O-Ring Br,		  
26	2	218-5280	ELBOW 90°, 3/4"-16, 37° x 9/16"-18, O-Ring,		  
27	2	218-654	CONNECTION, 4 WAY 3/4"-16, 37°,		 
28	8	14891660	PIN, SPECIAL 1 x 4.30		
29	UAR	22510700	CLAMP, HOSE 5/8		
29	UAR	22510710	CLAMP, HOSE 3/4		
30	UAR	433-616	BOLT, CARRIAGE Short NK, 3/8"-16 x 1", G5,		
31	UAR	86992213	NUT, LOCK 3/8, NC, Stover		 
32	UAR	289862C1	STRAP, CABLE 3/16" x 7", Tie		  

200 : TIGER-MATE CASE IH FIELD CULTIVATOR

35.100.07 - FRONT WING LIFT HYDRAULICS OPTION 46-1/2 THROUGH 50-1/2

Ссылка	Кол-во	Номер по каталогу	Описание	ОН	Индикаторы
33	4	495-21106	WASHER 1", Standard Flat		
34	12	87374	WASHER 1", Machine, 10 ga		
35	UAR	432-1632	PIN, SPLIT (COTTER) 1/4" x 2",		
36	4	25705041	COUPLING Male, ISO, 3/4 SAEF		
37	2	218-845	TEE 37°, 3/4"-16 x 3/4"-16, Fem Sw Run, Tube, Side Swive		
38	2	25600681	HOSE ASSY. 3/8 x 121		
39	2	25600684	HOSE ASSY. 3/8 x 132		
40	1	25600724	HOSE ASSY. 3/8 x 104-1/2		
41	1	25600664	HOSE ASSY. 3/8 x 60		
42	1	218-5230	ELBOW 90°, 3/4"-16, 37° x 3/4"-16, 37° Fem Sw,		
43	1	25600738	HOSE ASSY. 3/8 x 33-1/2		
44	1	25600618	HOSE ASSY. 3/8 x 18		
45	1	87328528	VALVE, SHUT-OFF Hydraulic Shut Off		
46	1	87328931	PLATE Bracket		
47	1	87343258	DECAL Hydraulic Transport Operation		
48	1	87353780	DECAL Warning Crushing Hazard		
49	1	87353782	DECAL Transport Hazard		
50	2	413-616	BOLT Hex, 3/8"-16 x 1", G5, Full Thd,		
51	2	86992213	NUT, LOCK 3/8, Hex, Stover		
52	2	86992212	NUT, LOCK 5/16, Hex, Stover		





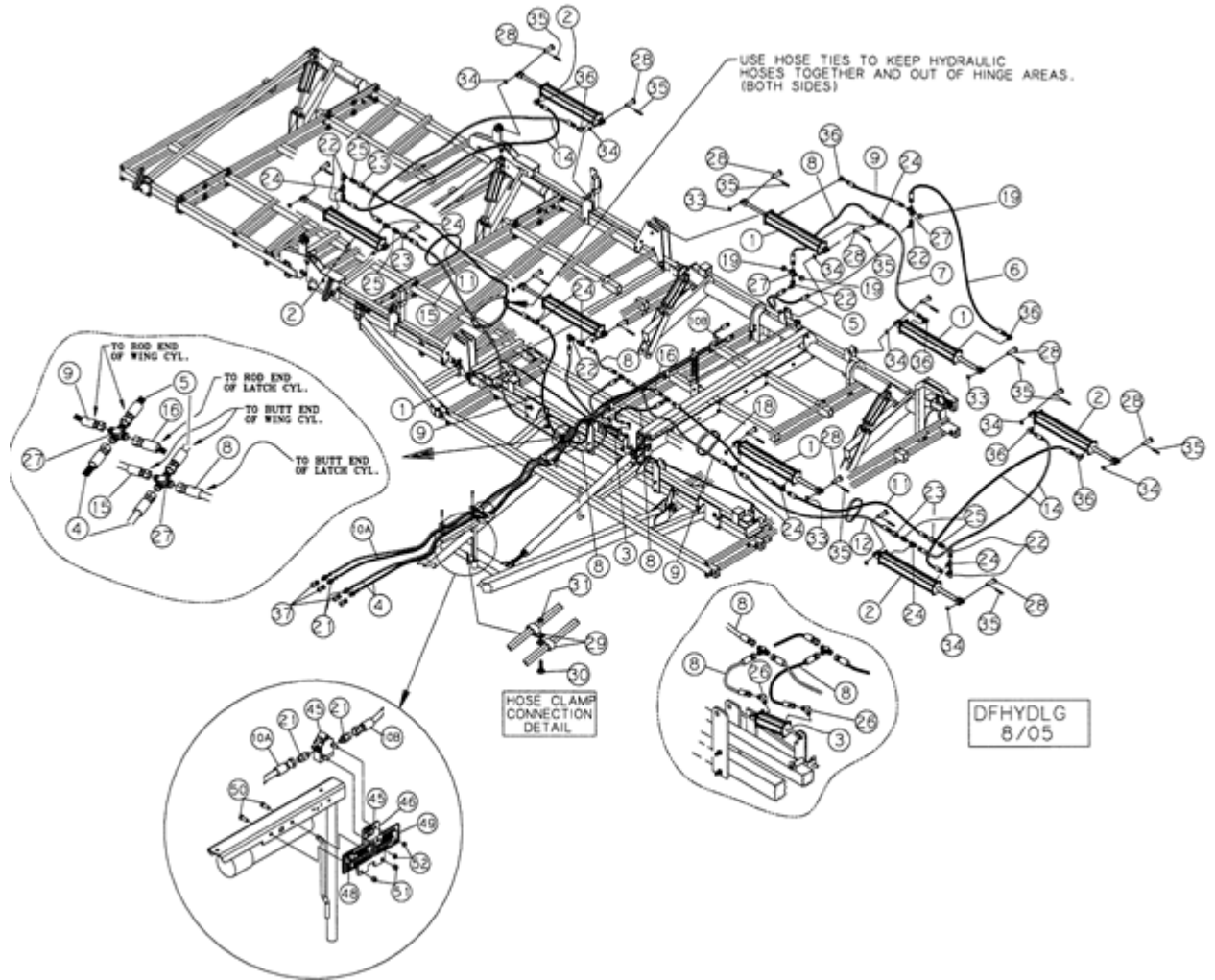

































200 : TIGER-MATE CASE IH FIELD CULTIVATOR

35.100.08 - WING FOLD HYDRAULICS 54-1/2 THROUGH 60-1/2









200 : TIGER-MATE CASE IH FIELD CULTIVATOR

35.100.08 - WING FOLD HYDRAULICS 54-1/2 THROUGH 60-1/2

Ссылка	Кол-во	Номер по каталогу	Описание	ОН	Индикаторы
1	2	25335361	CYLINDER ASSY. 3-1/2 x 36, 3000 psi, Front Inner Wing Lift		 
1	2	25340362	CYLINDER ASSY. 4 x 36, 3000 psi, Rear Inner Wing Lift		 
2	2	25335242	CYLINDER ASSY. 3-1/2 x 24, 3000 psi, Front Outer Wing Lift		 
2	2	25340242	CYLINDER ASSY. 4 x 24, 3000 psi, Rear Outer Wing Lift		 
3	1	25320040	CYLINDER ASSY. 2 x 4, 3000 psi		 
4	2	25600707	HOSE ASSY. 3/8 x 246		
5	2	25600726	HOSE ASSY. 3/8 x 130-1/2		
6	1	25600724	HOSE ASSY. 3/8 x 104-1/2		
7	1	25600708	HOSE ASSY. 3/8 x 50		
8	4	25600613	HOSE ASSY. 3/8 x 12		
9	3	25600614	HOSE ASSY. 3/8 x 36		
10	1	134209A1	HOSE 1/2 x 345		
10A	1	91202C1	HOSE 1/2 x 85		 
10B	1	1978106C1	HOSE 1/2 x 240		
11	2	25600606	HOSE ASSY. 3/8 x 150		
12	1	25600752	HOSE ASSY. 3/8 x 161		
14	4	25600706	HOSE ASSY. 3/8 x 144		
15	1	25600717	HOSE ASSY. 3/8 x 155		
16	1	25600714	HOSE ASSY. 3/8 x 26		
17	1	25600614	HOSE ASSY. 3/8 x 36		
18	1	25600607	HOSE ASSY. 3/8 x 76		
19	3	218-755	CAP 37°, 3/4"-16,		
21	6	218-5059	CONNECTOR, HYD. 3/4"-16, 37° x 3/4"-16, O-Ring,		 
22	6	218-5230	ELBOW 90°, 3/4"-16, 37° x 3/4"-16, 37° Fem Sw,		 
23	4	25405013	VALVE, CONTROL Throttle, Purple		
24	9	218-5183	TEE 3/4"-16, 37° x 3/4"-16, O-Ring Br,		 
25	4	25707534	ADAPTER 3/4 SAEM x 3/4 JICF		
26	2	218-5280	ELBOW 90°, 3/4"-16, 37° x 9/16"-18, O-Ring,		 
27	4	218-654	CONNECTION, 4 WAY 3/4"-16, 37°,		
28	16	14891660	PIN, SPECIAL 1 x 4.30		
29	UAR	22510700	CLAMP, HOSE 5/8		
29	UAR	22510710	CLAMP, HOSE 3/4		
30	UAR	433-616	BOLT, CARRIAGE Short NK, 3/8"-16 x 1", G5,		
31	UAR	86992213	NUT, LOCK 3/8, NC, Stover		 
32	UAR	289862C1	STRAP, CABLE 3/16" x 7",		 
33	4	495-21106	WASHER 1", Standard, Flat		
34	12	87374	WASHER 1", Machine, 10 ga		 
35	UAR	432-1632	PIN, SPLIT (COTTER) 1/4" x 2",		 
36	7	218-5106	ELBOW 90°, 3/4"-16, 37° x 3/4"-16, O-Ring,		 

200 : TIGER-MATE CASE IH FIELD CULTIVATOR

35.100.08 - WING FOLD HYDRAULICS 54-1/2 THROUGH 60-1/2

Ссылка	Кол-во	Номер по каталогу	Описание	ОН	Индикаторы
37	4	25705041	COUPLING Male, ISO, 3/4 SAEF		
38	2	25600618	HOSE ASSY. 3/8 x 18		
45	1	87328528	VALVE, SHUT-OFF Hydraulic Shut Off		
46	1	87328931	PLATE Bracket		
47	1	87343258	DECAL Hydraulic Transport Operation		
48	1	87353780	DECAL Warning Crushing Hazard		
49	1	87353782	DECAL Transport Hazard		
50	2	413-616	BOLT Hex, 3/8"-16 x 1", G5, Full Thd,		  
51	2	86992213	NUT, LOCK 3/8 Hex, Stover		 
52	2	86992212	NUT, LOCK 5/16, Hex, Stover		





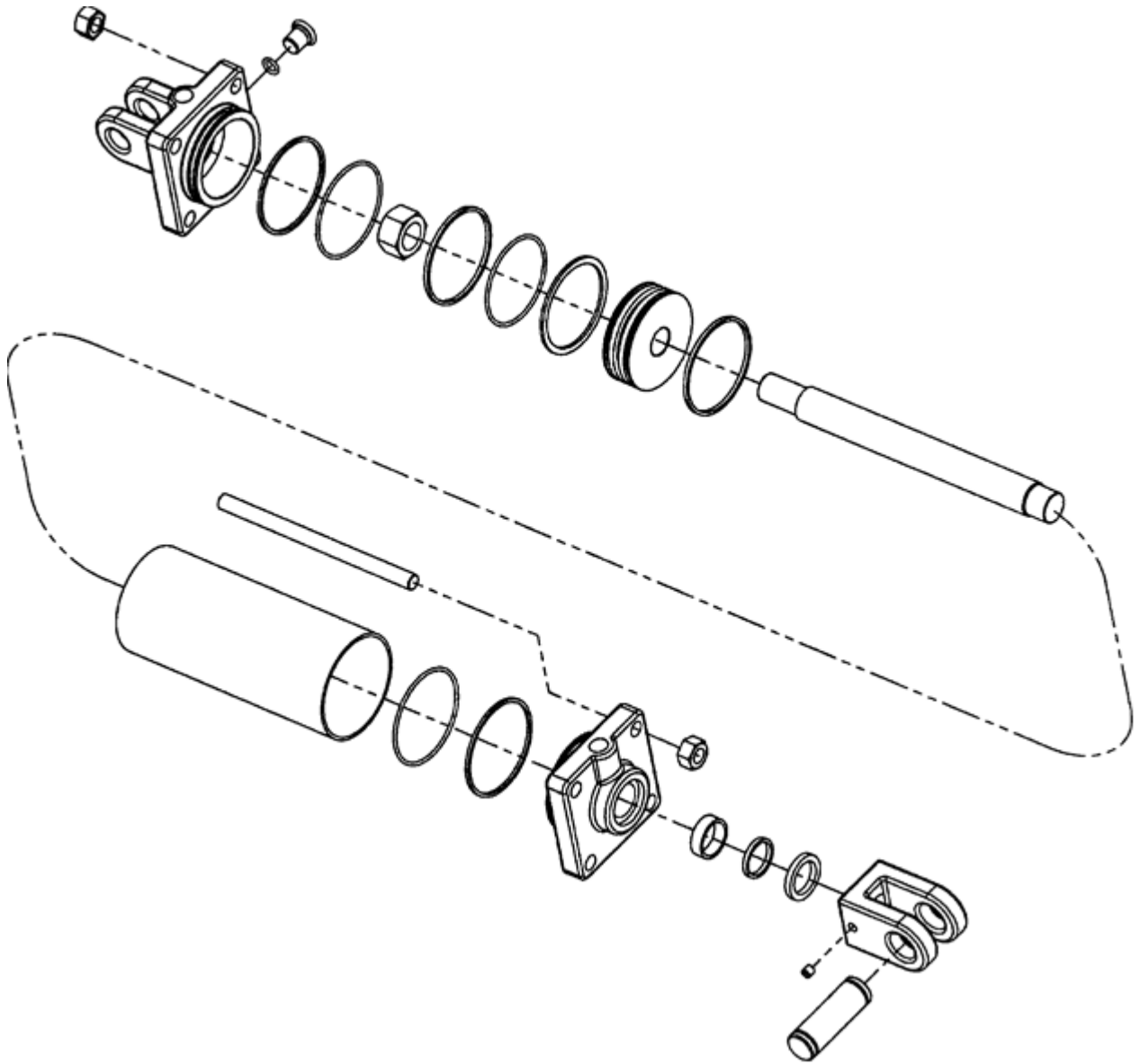

























200 : TIGER-MATE CASE IH FIELD CULTIVATOR

35.100.09 - HYDRAULIC CYLINDERS 3000 PSI



200 : TIGER-MATE CASE IH FIELD CULTIVATOR

35.100.09 - HYDRAULIC CYLINDERS 3000 PSI

Ссылка	Кол-во	Номер по каталогу	Описание	ОН	Индикаторы
1	1	87423770	HYDRAULIC CYLINDER 3-1/4 x 8, Rephase		 
1	1	87423771	CYLINDER ASSY. 3-1/2 x 8, Rephase		 
1	1	25340301	CYLINDER ASSY. 4 x 30		 
1	1	25340362	CYLINDER ASSY. 4 x 36		 
1	1	25320040	CYLINDER ASSY. 2 x 4		 
1	1	25330241	CYLINDER ASSY. 3 x 24		 
1	1	25330360	CYLINDER ASSY. 3 x 36		 
1	1	25335242	CYLINDER ASSY. 3-1/2 x 24		 
1	1	25335361	CYLINDER ASSY. 3-1/2 x 36		 
1	1	25340242	CYLINDER ASSY. 4 x 24		 
1	1	87423768	HYDRAULIC CYLINDER 3 x 8		 
1	1	87423766	CYLINDER 3-3/4 x 8, Rephase		 
1	1	87423777	HYDRAULIC CYLINDER 4 x 8		 
2	1	25833050	SEAL, HYD-CYLINDER 2 x 4		
2	1	25803100	SEAL, HYD-CYLINDER 3 x 8		
2	1	87409037	KIT, SEALS 3-1/4 x 8		
2	1	87409038	KIT, SEALS 3-1/2 x 8		
2	1	25834024	SEAL, HYD-CYLINDER 4 x 24 And 4 x 30 And 4 x 36		
2	1	25833007	KIT, SEALS 3 x 24 And 3 x 36		
2	1	25833527	SEAL, HYD-CYLINDER 3-1/2 x 24 And 3-1/2 x 36		
2	1	25803750	KIT 3-3/4 x 8		
2	1	87409033	KIT, SEALS 4 x 8		
3	1	25890100	KIT All Cylinders		 

200 : TIGER-MATE CASE IH FIELD CULTIVATOR

39.100.01 - SINGLE FOLD MAIN FRAME 12-1/2 THROUGH 38-1/2

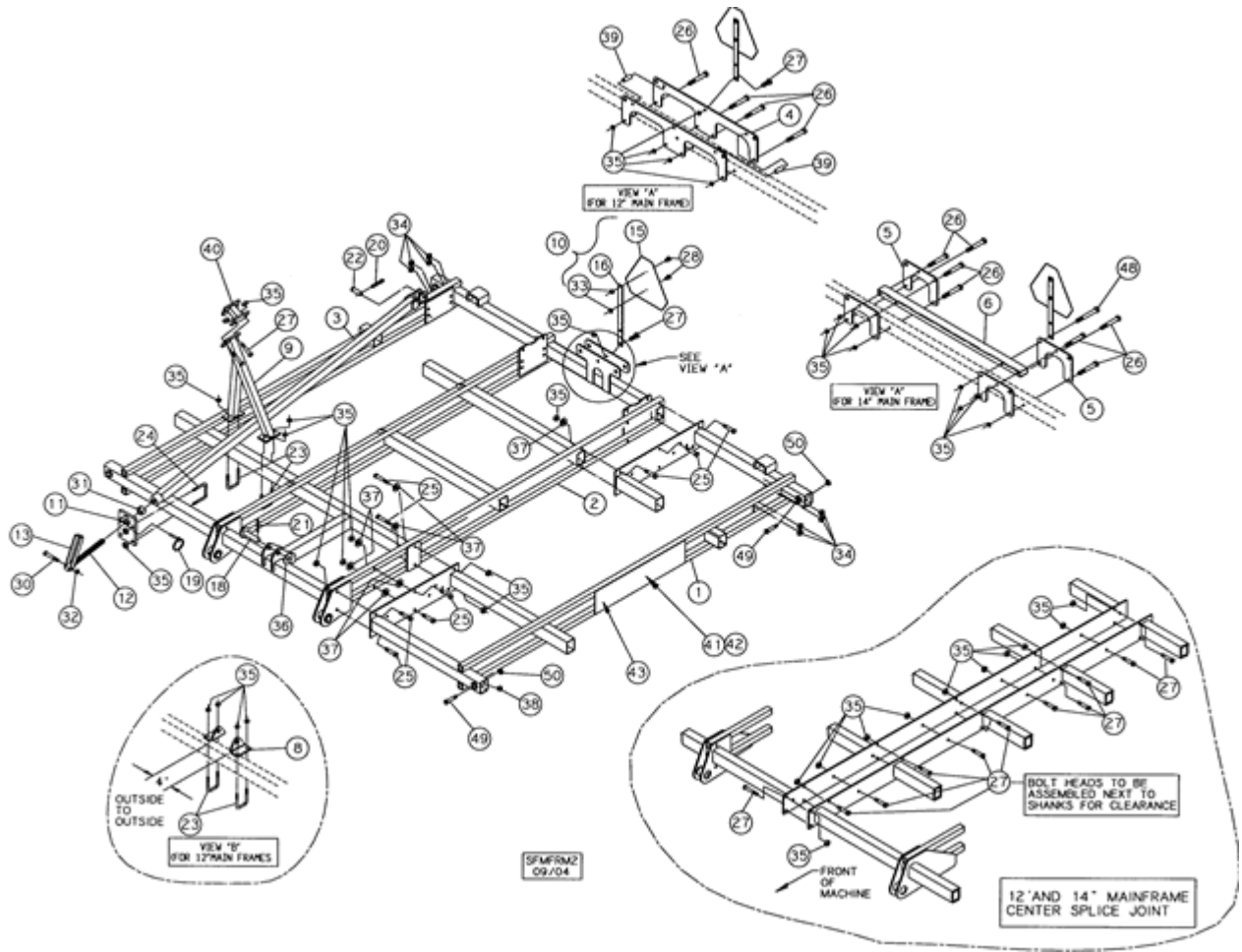

200 : TIGER-MATE CASE IH FIELD CULTIVATOR

39.100.01 - SINGLE FOLD MAIN FRAME 12-1/2 THROUGH 38-1/2

Ссылка	Кол-во	Номер по каталогу	Описание	ОН	Индикаторы
1	1	87394967	FRAME 10, Lh		
1	1	87394969	FRAME 12, Lh		
1	1	87394972	FRAME 14, Lh		
2	1	87394966	FRAME 10, Rh		
2	1	87394968	FRAME 12, Rh		
2	1	87394970	FRAME 14, Rh		
3	2	06400140	TUBE Depth, 2-1/2 x 2-1/2		
4	2	86993553	LUG 12, Mainframe		
5	4	86993577	LUG 14, Single Fold Mainframe		
6	2	86993579	BAR ASSY. 14, Single Fold Brace		
8	2	06400460	BRACKET Rocker Arm		
9	2	86993561	STOP DEVICE Wing, Single Fold		
10	1	18582000	PRODUCT GRAPHIC Kit		
11	2	06400130	PLATE, PIVOT Depth Adjust		
12	2	06400170	SCREW, ADJUSTMENT 1-1/4 Dia. Thread		
13	2	06400160	HANDLE, CRANKED Depth Adjust		
15	1	311860A1	EMBLEM SMV, Steel Back		
16	1	06200199	PRODUCT GRAPHIC SMV		
18	1	14820442	CLEVIS 1-1/4 Dia. x 5-1/2		
19	2	D33805	PIN 7/16 x 2		
20	2	432-1632	PIN, SPLIT (COTTER) 1/4" x 2",		
21	1	438-32440	PIN 3/8" x 2 1/2", Coiled,		
22	1	25890100	KIT 1, Cylinder		
23	UAR	87629102	U-BOLT		
24	4	87629089	U-BOLT		
25	12	413-1064	BOLT Hex, 5/8"-11 x 4", G5, 10 Mainframe		
26	14	413-1072	BOLT Hex, 5/8"-11 x 4 1/2", G5,		
27	UAR	413-1028	BOLT Hex, 5/8"-11 x 1 3/4", G5,		
28	2	413-412	BOLT Hex, 1/4"-20 x 3/4", G5, Full Thd,		
30	2	413-848	BOLT Hex, 1/2"-13 x 3", G5,		
31	2	25-1420	NUT Jam, 1 1/4"-7, G5,		
32	2	86992215	NUT, LOCK 1/2"-13, GC, Stover		
33	2	86992211	NUT, LOCK 1/4, NC, Hex		
34	UAR	280375	NUT, LOCK 3/4"-10, GC,		
35	UAR	85700693	NUT, LOCK 5/8"-11, GC,		
36	1	17620030	BUSHING 1-1/4 x 10 ga		
37	14	87613192	WASHER		
38	8	219-86	NIPPLE, LUBE 1/8" x .62" lg, Drive,		
39	2	06400430	SPACER		
40	2	06400440	STOP Wing		
41	1	18535012	DECAL TMII Case IH, Rh		
42	1	18535011	DECAL TMII Case IH, Lh		
43	2	311864A1	REFLECTOR Amber		
44	1	18534307	DECAL Helping Plants Thrive		

200 : TIGER-MATE CASE IH FIELD CULTIVATOR

39.100.01 - SINGLE FOLD MAIN FRAME 12-1/2 THROUGH 38-1/2

Ссылка	Кол-во	Номер по каталогу	Описание	ОН	Индикаторы
47	1	18534308	DECAL Depth Control		
48	1	88729	BOLT Hex, 5/8"-11 x 5", G5,		 
49	4	16902025	SCREW 1-1/4 x 6.56, Hex		 
50	4	86992220	NUT, LOCK 1-1/4, Stover		

200 : TIGER-MATE CASE IH FIELD CULTIVATOR

39.100.02 - SINGLE FOLD LIFT SYSTEM

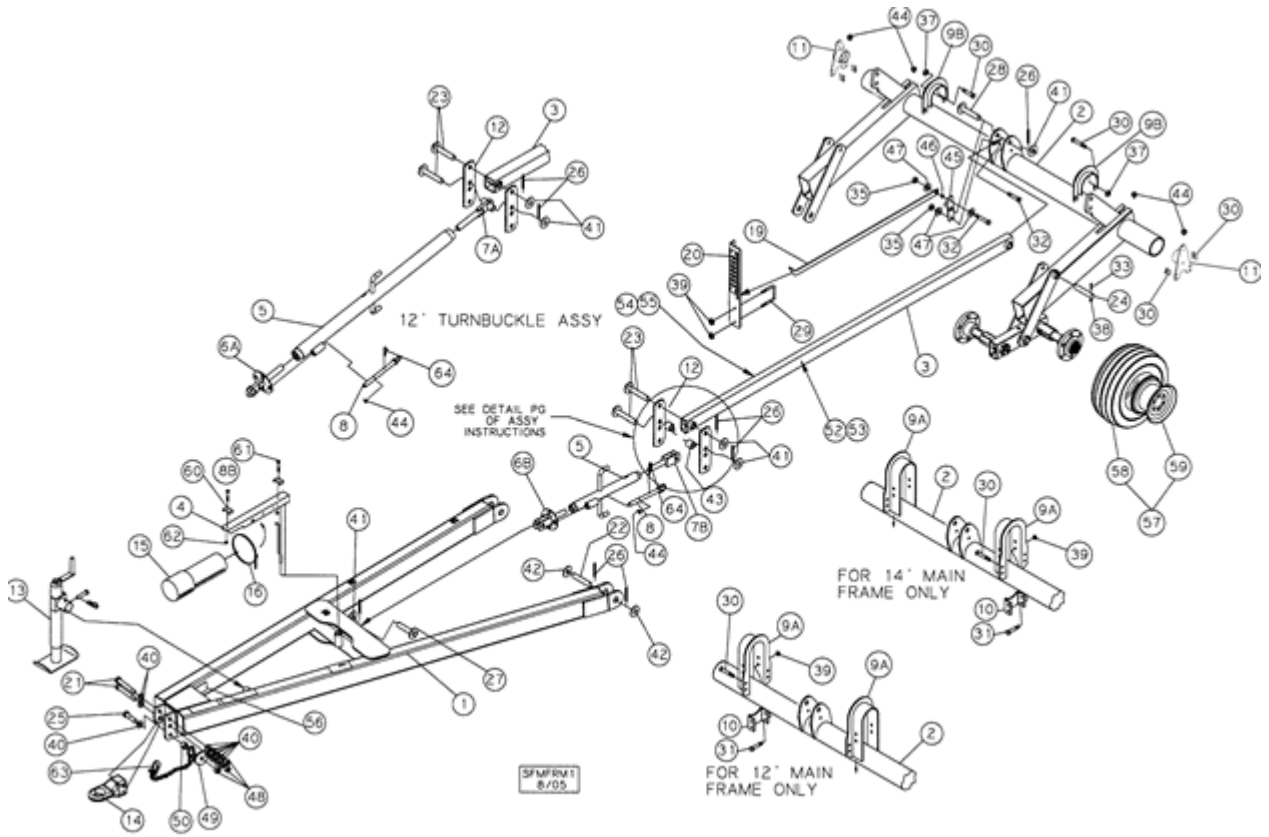

GS08A005













































200 : TIGER-MATE CASE IH FIELD CULTIVATOR

39.100.02 - SINGLE FOLD LIFT SYSTEM

Ссылка	Кол-во	Номер по каталогу	Описание	ОН	Индикаторы
1	1	87445705	FRAME ASSY 10 Mainframe		
1	1	87445707	FRAME ASSY 12 Mainframe		
1	1	87445709	FRAME, DRAWBAR 14 Mainframe		
2	1	87337184	ROCKSHAFT 10 Mainframe, With Tandems		
2	1	87455061	ROCKSHAFT 10 Mainframe, Without Tandems		
2	1	87337222	ROCKSHAFT 12 Mainframe, With Tandems		
2	1	06400200	AXLE 12 Mainframe, Without Tandems		
2	1	87337249	ROCKSHAFT 14 Mainframe, With Tandems		
2	1	06400400	AXLE 14 Mainframe, Without Tandems		
2	1	84235587	ROCKSHAFT 14 Mainframe, With Tandems, 2009 And After Models		
2	1	06400551	14 Mainframe, Without Tandems, 2009 And After Models		
3	1	87403177	LINK, CONNECTING Constant Level, Rear, 10 Mainframe		
3	1	86993573	LINK, CONNECTING Constant Level, Rear, 12 And 14 Mainframe		
4	1	05302150	STAND Hose		
5	1	87448226	TURNBUCKLE Assembly, 10 Mainframe		
5	1	87449029	TURNBUCKLE Assembly, 12 Mainframe		
5	1	87449031	TURNBUCKLE Assembly, 14 Single Fold, Mainframe		
6A	1	87449026	CLEVIS 1-1/2 Lh, 12 And 14 Mainframe		
6B	1	87448225	CLEVIS 1-1/4 Lh, 10 Mainframe		
7A	1	32408110	CLEVIS 1-1/2 Rh, 12 And 14 Mainframe		
7B	1	32408060	CLEVIS 1-1/4 Rh, 10 Mainframe		
8	1	395028A2	PIN, HITCH Turnbuckle, 10 Mainframe		
8B	1	32408130	NUT, LOCK 1-1/2 Jam, 12 And 14 Mainframe		
9A	2	06401020	CLAMP, DRAWBAR Rockshaft, 12 And 14 Mainframe		
9B	2	06401055	CLAMP, DRAWBAR Rockshaft, 10 Mainframe		
10	2	06401025	BRACKET Rockshaft, 12 And 14 Mainframe		
11	2	87458288	MOUNTING PARTS Rockshaft And Light		









200 : TIGER-MATE CASE IH FIELD CULTIVATOR

39.100.02 - SINGLE FOLD LIFT SYSTEM

Ссылка	Кол-во	Номер по каталогу	Описание	ОН	Индикаторы
12	2	06400590	BAR ASSY. 12 And 14, Single Fold		
12	2	06400690	BAR ASSY. 10 Mainframe		
13	1	32252000	JACK ASSY. 5000 lb		
14	1	362933A1	HITCH Catagory 3, 10 Mainframe		
14	1	362934A1	HITCH ASSY Catagory 4, 12 And 14 Mainframe		
15	1	30026030	TUBE Manual		
16	1	214-1452	CLAMP, HOSE #52, 2.81/3.75 Type F Worm,		 
19	1	06400760	INDICATOR		
20	1	06400770	GAUGE		
21	1	87030492	BOLT Hex, 1"-8 x 8 1/2", G8,		
22	2	14892649	PIN, SPECIAL 1-5/8 Dia. x 6.20, 12 And 14 Mainframe		
22	2	14892650	PIN, SPECIAL 1-5/8 Dia. x 5.83, 10 Mainframe		
23	2	14820442	CLEVIS 1-1/4 Dia. x 5.50		
24	2	14891630	PIN, SPECIAL 1 Dia. x 5.75		
25	1	413-1664	BOLT Hex, 1"-8 x 4", G5,		 
26	7	438-32440	PIN 3/8" x 2 1/2", Coiled,		 
27	1	14820211	CLEVIS 1-1/4 Dia. x 3.88		
28	1	14820461	CLEVIS 1-1/4 Dia. x 6.00		
29	1	87629089	U-BOLT		
30	UAR	413-1232	BOLT Hex, 3/4"-10 x 2", G5,		 
31	UAR	413-1028	BOLT Hex, 5/8"-11 x 1 3/4", G5,		  
32	2	413-824	BOLT Hex, 1/2"-13 x 1 1/2", G5, Full Thd,		  
33	2	413-640	BOLT Hex, 3/8"-16 x 2 1/2", G5,		 
35	2	86992215	NUT, LOCK 1/2"-13, GC, Stover		  
37	UAR	280375	NUT, LOCK 3/4"-10, GC,		 
38	2	86992213	NUT, LOCK 3/8, NC, Stover		 
39	UAR	85700693	NUT, LOCK 5/8"-11, GC,		 
40	10	87367	WASHER 1", SAE,		 
41	3	17620030	BUSHING 1-1/4 x 10 ga		
42	4	17627010	BUSHING 1-5/8 x 14 ga, Machine		
43	2	06401070	BUSHING, LARGE Turnbuckle, 10 Mainframe Only		
44	2	103-11100	RING, SNAP #100, .925", Ext, Retaining, External		
45	1	06400780	BRACKET Finger		
46	1	06400720	BUSHING, LARGE		
47	3	80700	WASHER 1/2",		  
48	3	86992219	NUT, LOCK 1, NC, Stover		
49	1	06400065	WASHER Heavy		
50	1	04681211	BUSHING		
51	1	413-1664	BOLT Hex, 1"-8 x 4", G5,		 
56	1	18534107	DECAL Patent		 
56	1	18534140	DECAL, WARNING Warning		



200 : TIGER-MATE CASE IH FIELD CULTIVATOR

39.100.02 - SINGLE FOLD LIFT SYSTEM

Ссылка	Кол-во	Номер по каталогу	Описание	ОН	Индикаторы
56	1	18534277	DECAL Warning, Spring Compression		
56	1	18534348	DECAL Warning, Towing Hazard		
57	4	10008256	WHEEL, LAND 9.5L x 15. 8 Ply Tire And Wheel, Tubeless, Silver, 18 Through 22 Models		
57	4	10008254	WHEEL, LAND 9.5L x 15, 8-Ply, Tire And Wheel, Tube, Silver, 18 Through 22 Models		
57	4	10008261	WHEEL, LAND 9.5L x 15, 12 Ply Tire And Wheel, Tube, Silver, 24 Through 30 Models, 10 Foot Mainframe		
57	4	10008258	WHEEL, LAND 9.5L x 15, 12 Ply Tire And Wheel, Tube, Silver, 24 Through 30, 10 Foot Mainframe		
57	4	10008262	WHEEL, LAND 9.5L x 15 FI (E), Tire And Wheel, Tubeless, Silver, 30 Through 38 Models, 12 Foot Mainframe		
57	4	10008263	WHEEL, LAND 9.5L x 15 FI (E), Tire And Wheel, Tube, Silver, 30 Through 38 Models, 12 Foot Mainframe		
57	4	84235573	9.5 x 15 FI (F), Tire And Wheel, Tubeless, Silver, 34 Through 38 Models, 14 Foot Mainframe, 2009 And After Models		
57	4	84235580	9.5 x 15 FI (F), Tire And Wheel, Tube, Silver, 34 Through 38 Models, 14 Foot Mainframe, 2009 And After Models		
58	4	10108254	WHEEL 8 x 15, 6-Hole With Guard, Silver		
58	4	10110281	WHEEL 8 x 15, 8 Hole With Guard, Silver		
59	4	NSS	NOT SERVICED SEPARATELY 9.5 x 15, 8-Ply, (1980928C1), 18 Through 22 Models		
59	4	NSS	NOT SERVICED SEPARATELY 9.5 x 15, 12 Ply, (11009152), 24 Through 30 Models, 10 Foot Mainframe		
59	4	NSS	NOT SERVICED SEPARATELY 9.5 x 15 FI (E), (11009160) 30 Through 38 Models, 12 Foot Mainframe		
59	4	NSS	NOT SERVICED SEPARATELY 9.5 x 15 FI (F) (84235555) 34 Through 38 Models, 2009 And After Models		

200 : TIGER-MATE CASE IH FIELD CULTIVATOR

39.100.02 - SINGLE FOLD LIFT SYSTEM

Ссылка	Кол-во	Номер по каталогу	Описание	ОН	Индикаторы
60	4	06200125	CLAMP, HOSE		 
61	2	413-648	BOLT Hex, 3/8"-16 x 3", G5,		 
62	2	86992213	NUT, LOCK 3/8, Stover		 
63	1	87393082	CHAIN 20,200 lb, Safety		
64	1	1978738C1	PIN, SPLIT (COTTER)		 
65	1	87348169	DECAL Tigermate II, Lh, Not Shown		
66	1	87348172	DECAL Tigermate II, Rh, Not Shown		

200 : TIGER-MATE CASE IH FIELD CULTIVATOR

39.100.03 - DOUBLE FOLD MAIN FRAME AND TRUSSES 38-1/2 THROUGH 50-1/2

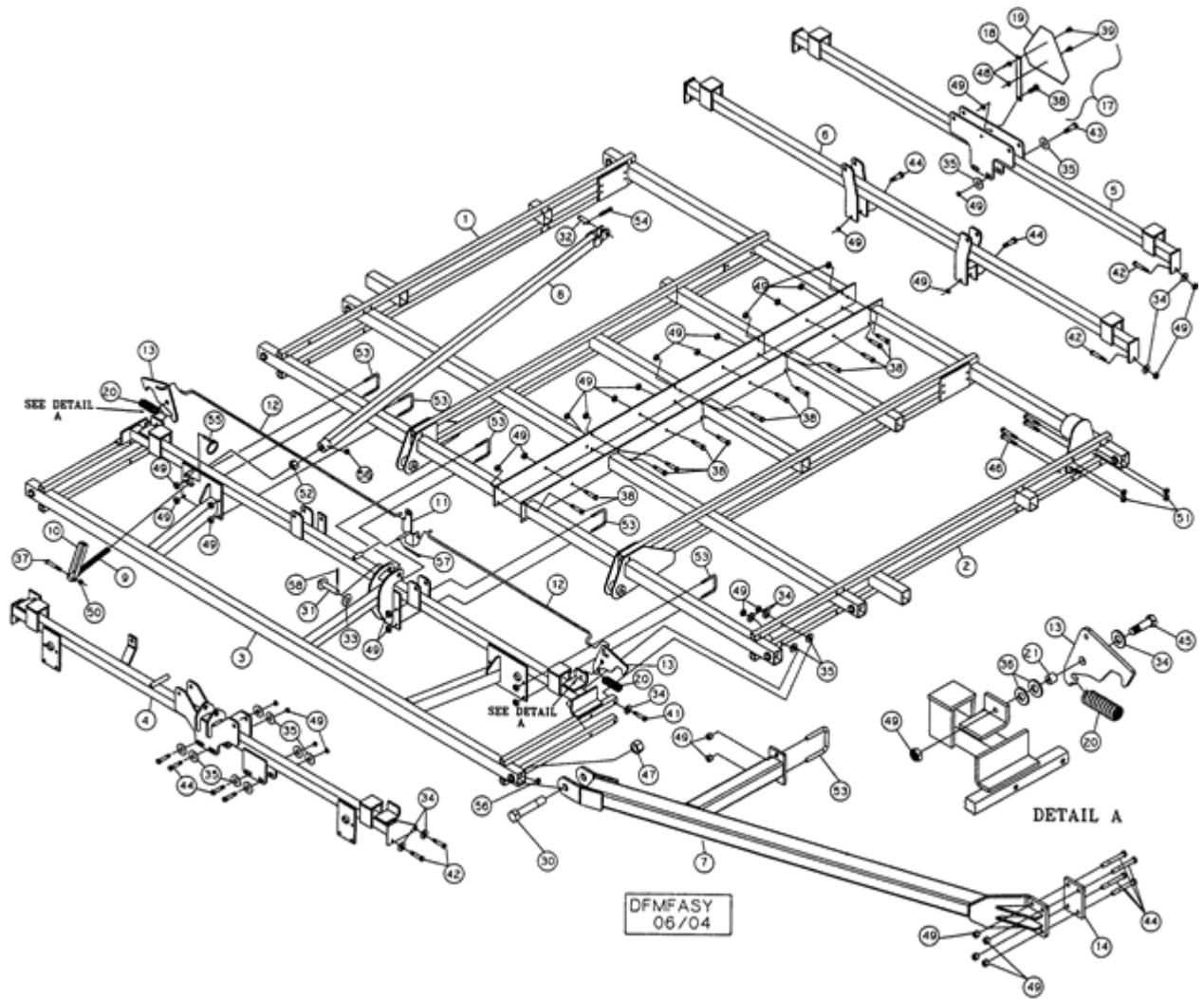



























200 : TIGER-MATE CASE IH FIELD CULTIVATOR

39.100.03 - DOUBLE FOLD MAIN FRAME AND TRUSSES 38-1/2 THROUGH 50-1/2

Ссылка	Кол-во	Номер по каталогу	Описание	ОН	Индикаторы
1	1	87394968	FRAME 12, Rh		
1	1	87394973	FRAME 14, Rh		
2	1	87394969	FRAME 12, Lh		
2	1	87394974	FRAME 14, Lh		
3	1	86993583	BAR ASSY. Front Bar, 14		
4	1	86993566	BAR ASSY. Front Truss, 12		
5	1	86993569	BAR ASSY. Rear Truss, 12		
6	1	86993572	BAR ASSY. Rear Truss, 14		
7	1	87453418	FRAME ASSY Inner Wing		
8	2	06400140	TUBE Depth Adjust, 2-1/2 x 2-1/2		
9	2	06400170	SCREW, ADJUSTMENT Depth Adjust, 1-1/4 Dia, Thread		
10	2	06400160	HANDLE, CRANKED Handle		
11	1	06400630	PIVOT ASSY. Cylinder Latch, 14		
11	1	06400634	LATCH Cylinder Latch, 12		
12	1	06400506	BRACKET Latch, 12, Rh		
12	1	06400507	BRACKET Latch, 12, Lh		
12	2	06400636	LATCH ASSY. Latch, 14		
13	2	06400640	LATCH ASSY. Wing		
14	2	87453387	PLATE, MOUNTING Mount		
15	2	06400670	SUPPORT Light		
17	1	18582000	PRODUCT GRAPHIC SMV		
18	1	06200199	PRODUCT GRAPHIC SMV		
19	1	311860A1	EMBLEM SMV		
20	2	24117700	SPRING, COMPRESSION Compression		
21	2	44006200	BUSHING		
30	UAR	16902025	SCREW 1-1/4 x 6.56, A-325, Hex		
31	1	14820442	CLEVIS 1-1/4 Dia. x 5-1/2 Lg.		
32	2	25890100	KIT 1, Bag		
33	7	17620030	BUSHING 1-1/4 x 10 ga, Machine		
34	1	87613192	WASHER		
35	UAR	80299	WASHER 5/8", Standard, Flat		
36	4	17618041	BUSHING, LARGE 1.125 Machine, 18 ga		
37	2	413-848	BOLT Hex, 1/2"-13 x 3", G5,		
38	15	413-1028	BOLT Hex, 5/8"-11 x 1 3/4", G5,		
39	2	413-412	BOLT Hex, 1/4"-20 x 3/4", G5, Full Thd,		
41	8	280232	BOLT Hex, 5/8"-11 x 5 1/2", G5,		
42	6	413-1056	BOLT Hex, 5/8"-11 x 3 1/2", G5, , For 12 Rear Truss		
42	2	413-1060	BOLT Hex, 5/8"-11 x 3 3/4", G5, , For 14 Rear Truss		
43	2	413-1072	BOLT Hex, 5/8"-11 x 4 1/2", G5,		
44	UAR	88729	BOLT Hex, 5/8"-11 x 5", G5,		
45	2	413-1040	BOLT Hex, 5/8"-11 x 2 1/2", G5,		

200 : TIGER-MATE CASE IH FIELD CULTIVATOR

39.100.03 - DOUBLE FOLD MAIN FRAME AND TRUSSES 38-1/2 THROUGH 50-1/2

Ссылка	Кол-во	Номер по каталогу	Описание	ОН	Индикаторы
46	8	413-1232	BOLT Hex, 3/4"-10 x 2", G5,		
47	UAR	86992220	NUT, LOCK 1-1/4, Stover		
48	10	86992211	NUT, LOCK 1/4, NC, Hex		 
49	UAR	85700693	NUT, LOCK 5/8"-11, GC,		 
50	2	86992215	NUT, LOCK 1/2"-13, GC, Stover		  
51	8	280375	NUT, LOCK 3/4"-10, GC,		 
52	2	25-1420	NUT Jam, 1 1/4"-7, G5,		
53	UAR	87629089	U-BOLT		
54	2	432-1632	PIN, SPLIT (COTTER) 1/4" x 2",		 
55	2	D33805	PIN 7/16 x 2, Klik		 
56	UAR	219-86	NIPPLE, LUBE 1/8" x .62" lg, Drive,		  
57	1	432-1232	PIN, SPLIT (COTTER) 3/16" x 2",		 
58	1	438-32440	PIN 3/8" x 2 1/2", Coiled,		 
40	8	413-420	BOLT Hex, 1/4"-20 x 1 1/4", G5,		 

200 : TIGER-MATE CASE IH FIELD CULTIVATOR

39.100.04 - DOUBLE FOLD LIFT SYSTEM AND PULL FRAME 38-1/2 THROUGH 50-1/2...

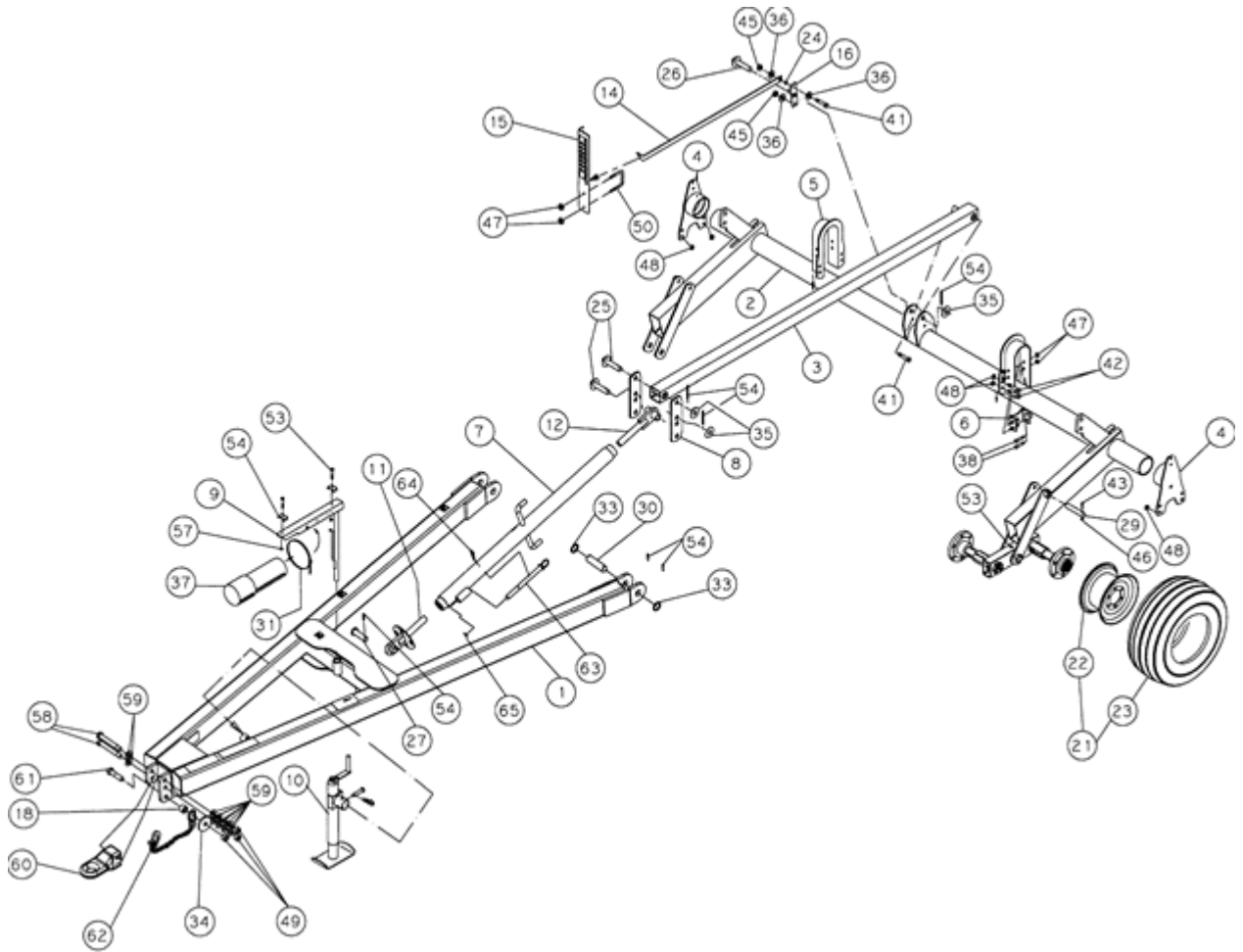

GS08A006























200 : TIGER-MATE CASE IH FIELD CULTIVATOR

39.100.04 - DOUBLE FOLD LIFT SYSTEM AND PULL FRAME 38-1/2 THROUGH 50-1/2...

Ссылка	Кол-во	Номер по каталогу	Описание	OH	Индикаторы
1	1	87445707	FRAME ASSY 12 Mainframe		
1	1	87445709	FRAME, DRAWBAR 14 Mainframe		
2	1	06400505	ROCKSHAFT 12 Mainframe, Without Tandems		
2	1	87337404	ROCKSHAFT 12 Mainframe, With Tandems		
2	1	87527143	ROCKSHAFT 14 Mainframe, Without Tandems		
2	1	87337427	ROCKSHAFT 14 Mainframe, With Tandems		
3	1	86993573	LINK, CONNECTING Constant Level, Rear		
4	2	87458288	MOUNTING PARTS Rock Shaft		
5	2	06401020	CLAMP, DRAWBAR Rock Shaft		
6	2	06401025	BRACKET Rock Shaft		
7	1	87449029	TURNBUCKLE 12 Mainframe		
7	1	87449031	TURNBUCKLE 14 Mainframe		
8	2	06400690	BAR ASSY. Rocker		
9	1	05302150	STAND Hose		
10	1	32252000	JACK ASSY. 5000 lb		
11	1	87449026	CLEVIS 1-1/2, Lh		
12	1	87449028	CLEVIS 1-1/2, Rh		
14	1	06400760	INDICATOR		
15	1	06400770	GAUGE		
16	1	06400780	BRACKET Finger		
18	1	04681211	BUSHING		
21	4	10010284	WHEEL, LAND 11L x 15 FI (F), Silver, Tube, 38 Through 46 Models		
21	4	10010283	WHEEL, LAND 11L x 15 FI (F), Silver, Tubeless, 38 Through 46 Models		
21	4	10010285	WHEEL ASSY. 12.5 x 15 FI (F), Silver, Tube, 48 Through 50 Models		
21	4	10010286	WHEEL ASSY. 12.5L x 15 FI (F), Silver, Tubeless, 48 Through 50 Models		
21	4	NSS	NOT SERVICED SEPARATELY 235/75R - 17.5 (H), Silver, Tube, 38 Through 46, 84188606		
21	4	NSS	NOT SERVICED SEPARATELY 235/75R - 17.5 (H), Silver Tubeless, 38 Through 46, 84188605		
21	4	NSS	NOT SERVICED SEPARATELY 12.5L - 16.5 (14 PR), Silver, Tube, 48 Through 60, 84159190		









































200 : TIGER-MATE CASE IH FIELD CULTIVATOR

39.100.04 - DOUBLE FOLD LIFT SYSTEM AND PULL FRAME 38-1/2 THROUGH 50-1/2...

Ссылка	Кол-во	Номер по каталогу	Описание	OH	Индикаторы
21	4	NSS	NOT SERVICED SEPARATELY 12.5L - 16.5 (14 PR), Silver, Tubeless, 48 Through 60, 84158180		
22	4	10110281	WHEEL 15 x 8, 8-Hole With Guard, Silver, Used With 10010183 And 10010184		
22	4	10110274	WHEEL 15 x 10, 8-Hole With Guard, Silver, Used With 10010179 And 10010180		 
22	4	84188494	WHEEL 17.5 x 6.75, B-Wheel, Silver		
22	4	84145657	RIM 16.5 x 9.75, B-Wheel, Silver		
23	4	NSS	NOT SERVICED SEPARATELY 11L x 15 FI (F) Tire (142356A1), Used With 10010183 And 10010184		
23	4	NSS	NOT SERVICED SEPARATELY 12.5L x 15 FI (F) Tire (347622A1), Used With 10010179 And 10010180		
23	4	NSS	NOT SERVICED SEPARATELY 235/15R - 17.5 (H) Tire (84188498)		
23	4	NSS	NOT SERVICED SEPARATELY 12.5L - 16.5 SL (14 PR) Tire (84132343)		
24	1	06400720	BUSHING, LARGE		
25	2	14820442	CLEVIS 1-1/4 Dia. x 5-1/2		
26	1	14820461	CLEVIS 1-1/4 Dia. x 6.00		
27	1	14820211	CLEVIS 1-1/4 Dia. x 3-7/8		
29A	2	14891623	PIN, SPECIAL 1 Dia. x 5.50, 12 Mainframe Only		
29B	2	14891630	PIN, SPECIAL 1 Dia. x 5.75, 14 Mainframe Only		
30	2	14892649	PIN, SPECIAL 1.625 Dia. x 6.200		
31	1	214-1452	CLAMP, HOSE #52, 2.81/3.75 Type F Worm,		 
33	4	17627010	BUSHING 1-5/8 ID x 14 ga, Machine		
34	1	06400065	WASHER Heavy		
35	8	17620030	BUSHING 1-1/4 x 10 ga, Machine		
36	3	80700	WASHER 1/2",		  
37	1	30026030	TUBE Manual		
38	8	413-1028	BOLT Hex, 5/8"-11 x 1 3/4", G5,		 
41	2	413-824	BOLT Hex, 1/2"-13 x 1 1/2", G5, Full Thd,		 
42	8	413-1232	BOLT Hex, 3/4"-10 x 2", G5,		

200 : TIGER-MATE CASE IH FIELD CULTIVATOR

39.100.04 - DOUBLE FOLD LIFT SYSTEM AND PULL FRAME 38-1/2 THROUGH 50-1/2...

Ссылка	Кол-во	Номер по каталогу	Описание	ОН	Индикаторы
43	2	413-640	BOLT Hex, 3/8"-16 x 2 1/2", G5,		 
44	2	86992211	NUT, LOCK 1/4, NC, Hex		  
45	2	86992215	NUT, LOCK 1/2"-13, GC, Stover		  
46	2	86992213	NUT, LOCK 3/8, NC, Stover		  
47	10	85700693	NUT, LOCK 5/8"-11, GC,		 
48	16	280375	NUT, LOCK 3/4"-10, GC,		 
49	3	86992219	NUT, LOCK 1, NC, Hex		
50	1	87629089	U-BOLT		
53	1	413-648	BOLT Hex, 3/8"-16 x 3", G5,		 
54	8	438-32440	PIN 3/8" x 2 1/2", Coiled,		 
55	4	06200125	CLAMP, HOSE		 
56	2	413-648	BOLT Hex, 3/8"-16 x 3", G5,		 
57	2	425-106	NUT 3/8"-16, G5,		   
58	2	87030492	BOLT Hex, 1"-8 x 8 1/2", G8,		
59	10	87367	WASHER 1", SAE,		 
60	1	362934A1	HITCH ASSY Catagory 4		
61	1	413-1664	BOLT Hex, 1"-8 x 4", G5,		 
62	1	87389757	CHAIN 30,400, Safety		
63	1	395028A2	PIN, HITCH Turnbuckle		
64	1	1978738C1	PIN, SPLIT (COTTER) Hair		 
65	1	103-11100	RING, SNAP #100, .925", Ext, Retaining, External		
39	2	413-420	BOLT Hex, 1/4"-20 x 1 1/4", G5,		  
66	1	87348169	DECAL Tigermate II, Lh, Not Shown		
67	1	87348172	DECAL Tigermate II, Rh, Not Shown		

200 : TIGER-MATE CASE IH FIELD CULTIVATOR

39.100.05 - 54-1/2 THROUGH 60-1/2 DOUBLE FOLD MAIN FRAME AND TRUSSES

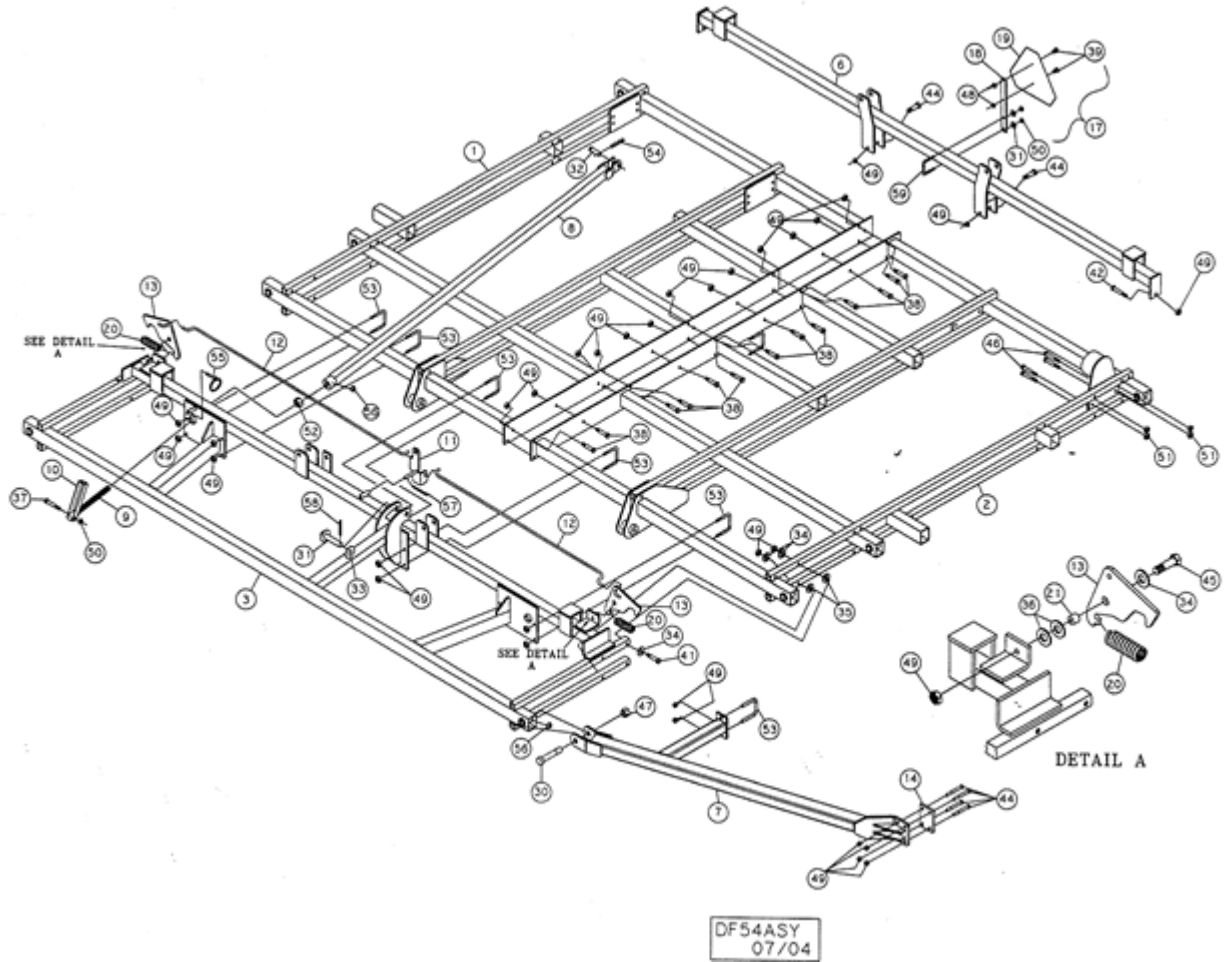

200 : TIGER-MATE CASE IH FIELD CULTIVATOR

39.100.05 - 54-1/2 THROUGH 60-1/2 DOUBLE FOLD MAIN FRAME AND TRUSSES

Ссылка	Кол-во	Номер по каталогу	Описание	ОН	Индикаторы
1	1	87394973	FRAME 14, Rh		
2	1	87394974	FRAME 14, Lh		
3	1	86993583	BAR ASSY. Front, 14, Main Frame		
6	1	86993572	BAR ASSY. Rear, 14, Main Frame		
7	2	87453418	FRAME ASSY Inner Wing		
8	2	06400140	TUBE Depth Adjust, 2-1/2 x 2-1/2		
9	2	06400170	SCREW, ADJUSTMENT Depth Adjust, 1-1/2 Dia., Thread		
10	2	06400160	HANDLE, CRANKED Handle		
11	1	06400630	PIVOT ASSY. Cylinder Latch		
12	2	06400636	LATCH ASSY. Latch, 14 Main Frame		
13	2	06400640	LATCH ASSY. Wing		
14	2	87453387	PLATE, MOUNTING Mount		
17	1	18582000	PRODUCT GRAPHIC SMV		
18	1	06200199	PRODUCT GRAPHIC SMV		
19	1	311860A1	EMBLEM SMV		
20	2	24117700	SPRING, COMPRESSION Compression		
21	2	44006200	BUSHING		
30	6	16902025	SCREW 1-1/4 x 6.56, A-325, Hex		
31	2	86992215	NUT, LOCK 1/2"-13, GC, Stover		
32	2	25890100	KIT 1, Bag		
33	1	17620030	BUSHING 1-1/4 x 10 ga, Machine		
34	UAR	87613192	WASHER		
35	UAR	80299	WASHER 5/8", Standard, Flat		
36	4	17618041	BUSHING, LARGE 1-1/8, Machine, 18 ga		
37	2	413-848	BOLT Hex, 1/2"-13 x 3", G5,		
38	15	413-1028	BOLT Hex, 5/8"-11 x 1 3/4", G5,		
41	8	280232	BOLT Hex, 5/8"-11 x 5 1/2", G5,		
42	6	413-1060	BOLT Hex, 5/8"-11 x 3 3/4", G5,		
43	2	413-1072	BOLT Hex, 5/8"-11 x 4 1/2", G5,		
44	UAR	88729	BOLT Hex, 5/8"-11 x 5", G5,		
45	2	413-1040	BOLT Hex, 5/8"-11 x 2 1/2", G5,		
46	8	413-1232	BOLT Hex, 3/4"-10 x 2", G5,		
47	6	86992220	NUT, LOCK 1-1/4, Stover		
49	UAR	85700693	NUT, LOCK 5/8"-11, GC,		
50	2	86992215	NUT, LOCK 1/2"-13, GC, Stover		
51	8	280375	NUT, LOCK 3/4"-10, GC,		
52	2	25-1420	NUT Jam, 1 1/4"-7, G5,		
53	UAR	87629089	U-BOLT		
54	2	432-1632	PIN, SPLIT (COTTER) 1/4" x 2",		
55	2	D33805	PIN 7/16 x 2, Klik		
56	UAR	219-86	NIPPLE, LUBE 1/8" x .62" lg, Drive,		

200 : TIGER-MATE CASE IH FIELD CULTIVATOR

39.100.05 - 54-1/2 THROUGH 60-1/2 DOUBLE FOLD MAIN FRAME AND TRUSSES

Ссылка	Кол-во	Номер по каталогу	Описание	ОН	Индикаторы
57	1	432-1232	PIN, SPLIT (COTTER) 3/16" x 2",		 
58	1	438-32440	PIN 3/8" x 2 1/2", Coiled,		 
59	1	16308125	U-BOLT 1/2 x 3 x 4		
39	2	413-420	BOLT Hex, 1/4"-20 x 1 1/4", G5,		 

200 : TIGER-MATE CASE IH FIELD CULTIVATOR

39.100.06 - 54-1/2 THROUGH 60-1/2 DOUBLE FOLD LIFT SYSTEM AND PULL FRAME

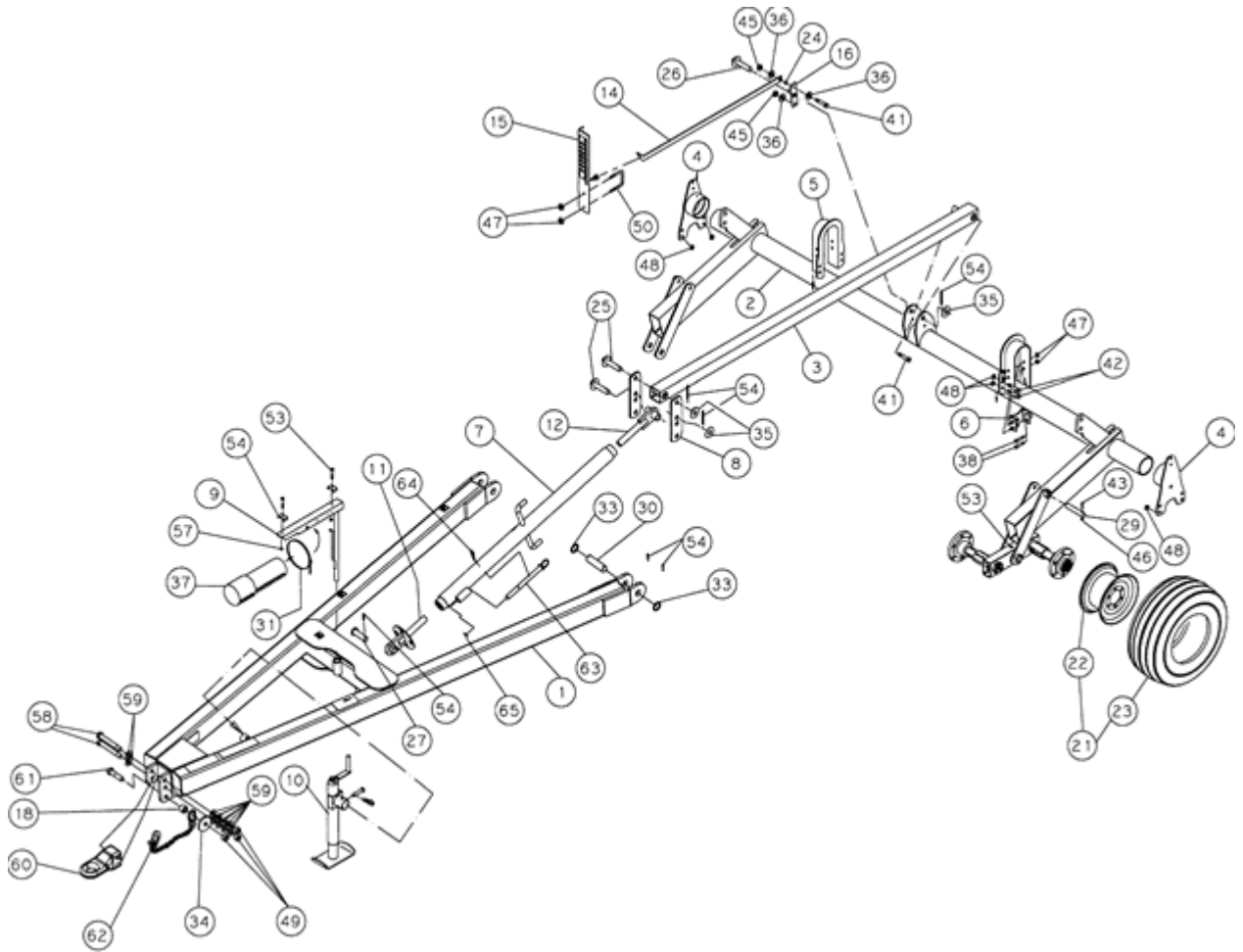

GS08A006











































200 : TIGER-MATE CASE IH FIELD CULTIVATOR

39.100.06 - 54-1/2 THROUGH 60-1/2 DOUBLE FOLD LIFT SYSTEM AND PULL FRAME

Ссылка	Кол-во	Номер по каталогу	Описание	OH	Индикаторы
1	1	87445709	FRAME, DRAWBAR 14 Mainframe		
2	1	87527143	ROCKSHAFT 14 Mainframe Without Tandems		
2	1	87337427	ROCKSHAFT 14 Mainframe With Tandems		
3	1	86993573	LINK, CONNECTING Constant Level Rear		
4	2	87458288	MOUNTING PARTS Rock Shaft		
5	2	06401020	CLAMP, DRAWBAR Rock Shaft		
6	2	06401025	BRACKET Rock Shaft		
7	1	87449031	TURNBUCKLE 14 Mainframe		
8	2	06400690	BAR ASSY. Rocker		
9	1	05302150	STAND Hose		
10	1	32252000	JACK ASSY. 5000 lb		
11	1	87449026	CLEVIS 1-1/2, Lh		
12	1	87449028	CLEVIS 1-1/2, Rh		
14	1	06400760	INDICATOR		
15	1	06400770	GAUGE		
16	1	06400780	BRACKET Finger		
18	1	04681211	BUSHING		
21	4	10010286	WHEEL ASSY. 12.5L - 15 FI (F), Tubeless, Silver		
21	4	10010285	WHEEL ASSY. 12.5L - 15 FI (F), Tube, Silver		
21	4	NSS	NOT SERVICED SEPARATELY 12.5L - 16.5 SL (14 PR) Silver, Tubeless, 84158180		
21	4	NSS	NOT SERVICED SEPARATELY 12.5L - 16.5 SL (14 PR) Silver, Tubeless, 84159190		
22	4	10110274	WHEEL 10 x 15, 8-Hole With Guard, Silver, Tube And Tubeless Type		
22	4	84145657	RIM 16.5 x 9.75, 8 Hole, Silver		
23	4	NSS	NOT SERVICED SEPARATELY 12.5L x 15 FI (F) Tire, 11012181, Tube And Tubeless Type		
23	4	NSS	NOT SERVICED SEPARATELY 21.5L - 16.5 SL (14 PR) Tire		
24	1	06400720	BUSHING, LARGE		
25	2	14820442	CLEVIS 1-1/4 Dia. x 5-1/2		
26	1	14820461	CLEVIS 1-1/4 Dia. x 6		
27	1	14820211	CLEVIS 1-1/4 Dia. x 3-7/8		
29	2	14891630	PIN, SPECIAL 1 Dia. x 5.75		
30	2	14892649	PIN, SPECIAL 1.625 Dia. x 6.200		
31	1	214-1452	CLAMP, HOSE #52, 2.81/3.75 Type F Worm,		
33	4	17627010	BUSHING 1-5/8 ID x 14 ga, Machine		

200 : TIGER-MATE CASE IH FIELD CULTIVATOR

39.100.06 - 54-1/2 THROUGH 60-1/2 DOUBLE FOLD LIFT SYSTEM AND PULL FRAME

Ссылка	Кол-во	Номер по каталогу	Описание	ОН	Индикаторы
34	1	06400065	WASHER Heavy		
35	8	17620030	BUSHING 1-1/4 x 10 ga, Machine		
36	3	80700	WASHER 1/2",		  
37	1	30026030	TUBE Manual		
38	8	413-1028	BOLT Hex, 5/8"-11 x 1 3/4", G5,		 
41	2	413-824	BOLT Hex, 1/2"-13 x 1 1/2", G5, Full Thd,		 
42	8	413-1232	BOLT Hex, 3/4"-10 x 2", G5,		
43	2	413-640	BOLT Hex, 3/8"-16 x 2 1/2", G5,		 
44	2	86992211	NUT, LOCK 1/4, NC, Stover		 
45	2	86992215	NUT, LOCK 1/2"-13, GC, Stover		  
46	2	86992213	NUT, LOCK 3/8, NC, Stover		 
47	10	85700693	NUT, LOCK 5/8"-11, GC,		 
48	2	280375	NUT, LOCK 3/4"-10, GC,		 
49	3	86992219	NUT, LOCK 1, NC, Stover		
50	1	87629089	U-BOLT		
51	8	432-1632	PIN, SPLIT (COTTER) 1/4" x 2",		 
54	4	06200125	CLAMP, HOSE		 
55	2	413-648	BOLT Hex, 3/8"-16 x 3", G5,		
56	2	425-106	NUT 3/8"-16, G5,		  
58	2	87030492	BOLT Hex, 1"-8 x 8 1/2", G8,		
59	10	87367	WASHER 1", SAE,		 
60	1	362934A1	HITCH ASSY Catagory 4		
61	1	413-1664	BOLT Hex, 1"-8 x 4", G5,		
62	1	87389757	CHAIN 30,400, Safety		
63	1	395028A2	PIN, HITCH Turnbuckle		
64	1	1978738C1	PIN, SPLIT (COTTER) Hair		 
65	1	103-11100	RING, SNAP #100, .925", Ext, Retaining, External		
39	2	413-420	BOLT Hex, 1/4"-20 x 1 1/4", G5,		 
66	1	87348169	DECAL Tigermate II, Lh, Not Shown		
67	1	87348172	DECAL Tigermate II, Rh, Not Shown		

200 : TIGER-MATE CASE IH FIELD CULTIVATOR

39.100.07 - WING FRAME SINGLE FOLD 12-1/2 THROUGH 38-1/2

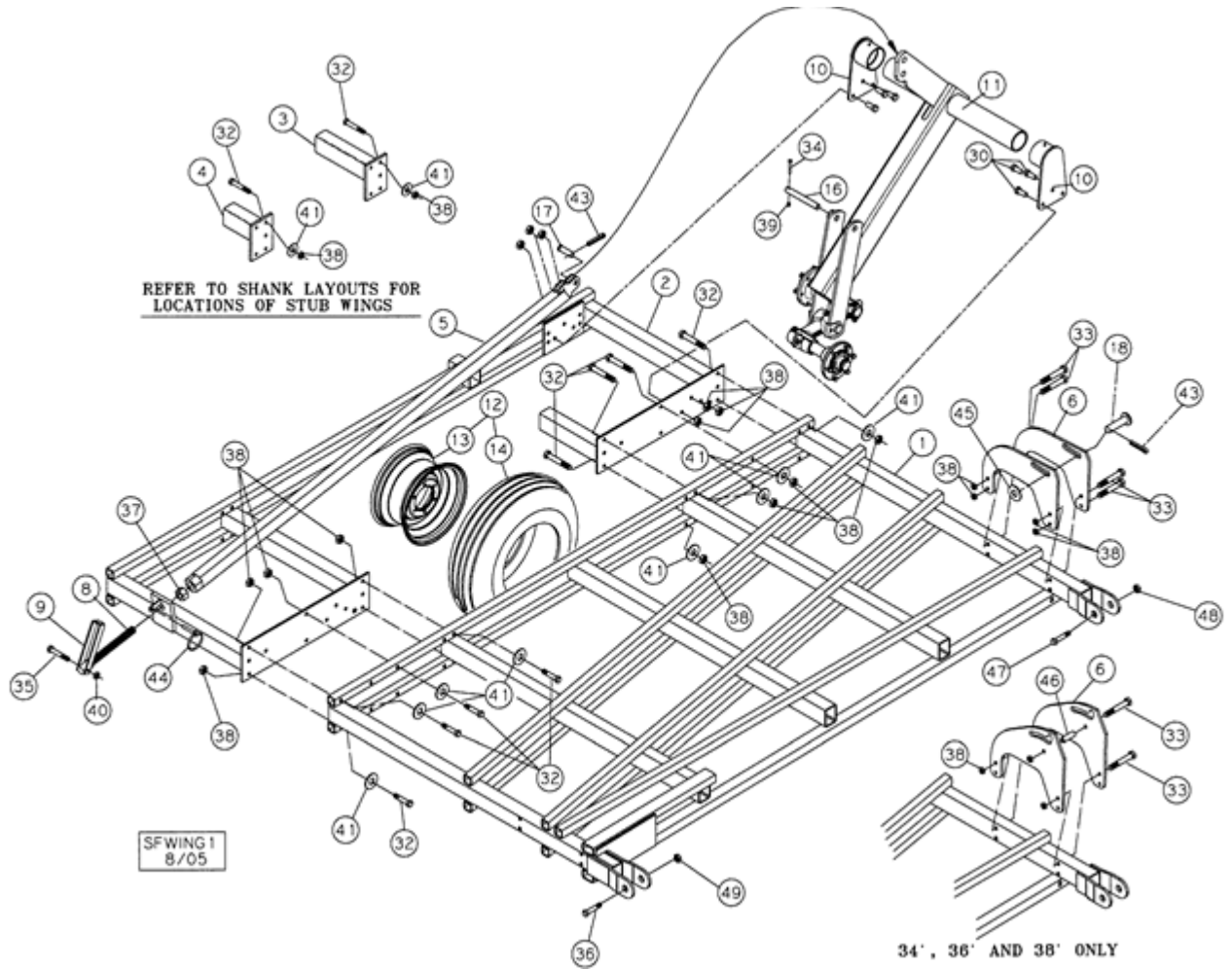































200 : TIGER-MATE CASE IH FIELD CULTIVATOR

39.100.07 - WING FRAME SINGLE FOLD 12-1/2 THROUGH 38-1/2

Ссылка	Кол-во	Номер по каталогу	Описание	ОН	Индикаторы
1	1	86993585	TUBE ASSY. 3-1/2, Rh		
1	1	86993587	TUBE ASSY. 3-1/2, Lh		
1	1	86993884	TUBE ASSY. 5-1/2, Rh		
1	1	86993886	TUBE ASSY. 5-1/2, Lh		
1	1	87394980	FRAME 7-1/2, Rh		
1	1	86993890	TUBE ASSY. 7-1/2, Lh		
1	1	86993984	TUBE ASSY. 9-1/2, Rh		
1	1	86993986	TUBE ASSY. 9-1/2, Lh		
2	1	86993597	TUBE ASSY. 9-1/2, Extension, Rh		
2	1	86993601	TUBE ASSY. 9-1/2, Extension, Lh		
2	1	86993603	TUBE ASSY. 11-1/2, Extension, Rh		
2	1	86993791	TUBE ASSY. 11-1/2, Extension, Lh		
3	UAR	86993852	TUBE ASSY. Stub, 9-1/2		
4	UAR	86993855	TUBE ASSY. Stub, 15-1/2		
5	2	06400820	STOP Depth Adjust, 2 x 2		
6	4	86993593	LUG Cylinder, 30-1/2 With 10 Mainframe		
6	4	86993589	LUG Cylinder, 18-1/2		
6	4	86993595	LUG Cylinder, 30-1/2 Through 32-1/2		
6	4	86993591	LUG Cylinder, 34-1/2 Through 38-1/2		
8	2	06400840	ADJUSTER Depth Adjust, 1-1/4 Thread, Stamped 2 On End		
9	2	06400160	HANDLE, CRANKED Depth Adjust		
10	4	06401190	AXLE Rock Shaft		
11	1	06401100	ROCKSHAFT Rh Wing, Without Tandems		
11	1	87337198	ROCKSHAFT Rh Wing, With Tandems		
11	1	06401150	AXLE Lh Wing, Without Tandems		
11	1	87337200	ROCKSHAFT Lh Wing, With Tandems		
12	4	10008256	WHEEL, LAND 9.5L x 15, 8-Ply, Tubeless, Silver		
12	4	10008254	WHEEL, LAND 9.5L x 15, 8-Ply, Tube, Silver		
13	4	10108254	WHEEL 8 x 15, 6-Hole With Guard, Tube, Silver		
14	4	NSS	NOT SERVICED SEPARATELY 9.5 x 15, 8-Ply Tire, 1980928C1		
16	2	14891630	PIN, SPECIAL 1 x 5.75		
17	1	25890100	KIT 1, Cylinder		
18	2	14891660	PIN, SPECIAL 1 x 4.30		
30	12	413-1028	BOLT Hex, 5/8"-11 x 1 3/4", G5,		

200 : TIGER-MATE CASE IH FIELD CULTIVATOR

39.100.07 - WING FRAME SINGLE FOLD 12-1/2 THROUGH 38-1/2

Ссылка	Кол-во	Номер по каталогу	Описание	ОН	Индикаторы
32	UAR	413-1056	BOLT Hex, 5/8"-11 x 3 1/2", G5,		 
33	8	88729	BOLT Hex, 5/8"-11 x 5", G5,		  
34	2	413-640	BOLT Hex, 3/8"-16 x 2 1/2", G5,		 
35	2	413-848	BOLT Hex, 1/2"-13 x 3", G5,		
36	2	16902025	SCREW 1-1/4 x 6.56, Hex		 
37	2	25-1420	NUT Jam, 1 1/4"-7, G5,		
38	UAR	85700693	NUT, LOCK 5/8"-11, GC,		 
39	2	86992213	NUT, LOCK 3/8, NC, Stover		 
40	2	86992215	NUT, LOCK 1/2"-13, GC, Stover		  
41	32	87613192	WASHER		
42	4	17620030	BUSHING 1-1/4 x 10 ga, Machinery		
43	4	432-1632	PIN, SPLIT (COTTER) 1/4" x 2",		 
44	2	D33805	PIN 7/16 x 2, Klik		 
45	2	87374	WASHER 1", Standard		 
46	2	06400430	SPACER Cylinder Lug		
47	2	16902025	SCREW 1-1/4 x 6.56, Hex		 
48	2	86992220	NUT, LOCK 1-1/4, Stover		
49	2	86992220	NUT, LOCK 1-1/4, Stover		
50	2	86992870W	FRAME Rear Wing Rest, Not Shown, Used With ACS Harrow Option		

200 : TIGER-MATE CASE IH FIELD CULTIVATOR
39.100.08 - DOUBLE FOLD INNER WING 38-1/2 THROUGH 50-1/2 MODELS

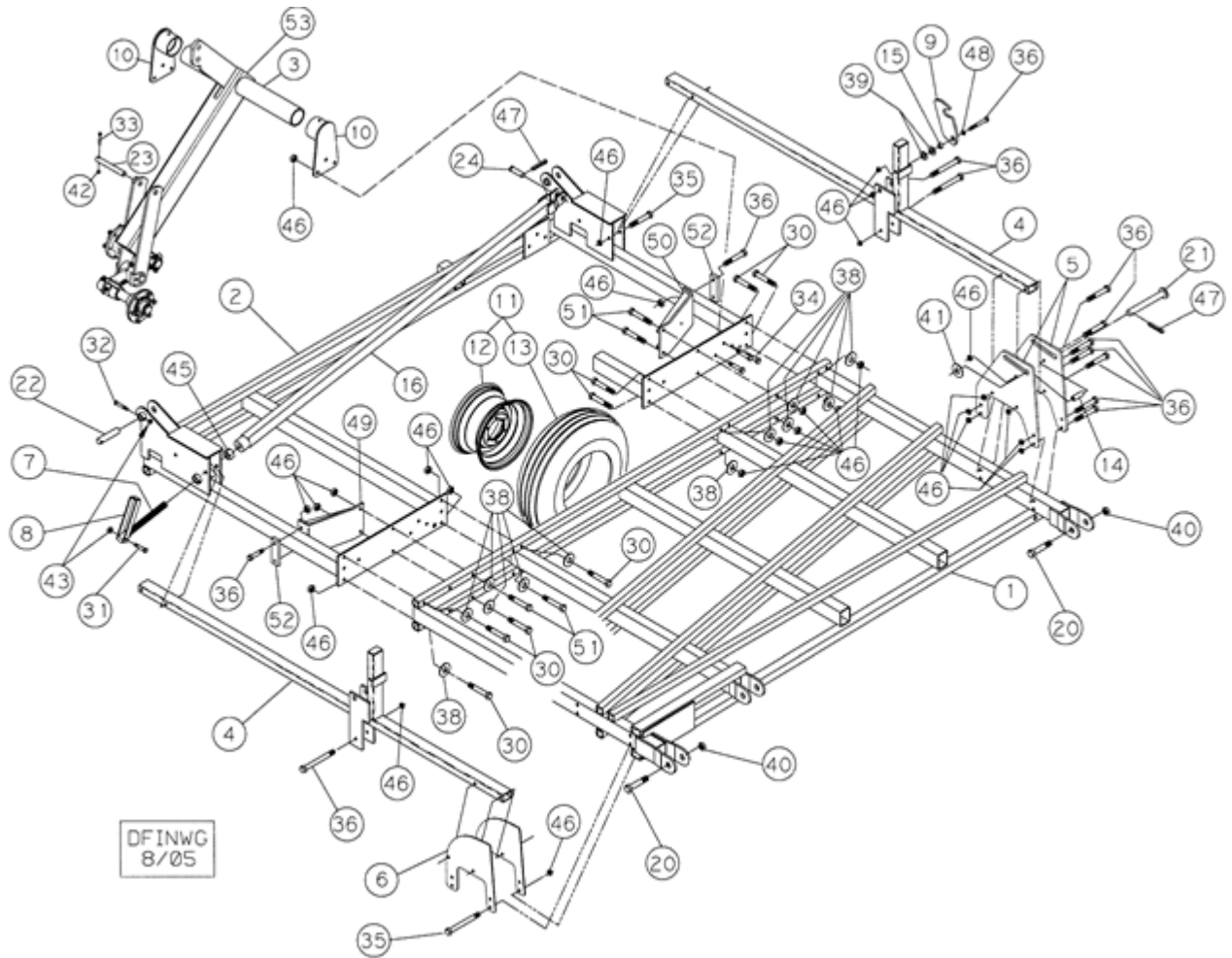

































200 : TIGER-MATE CASE IH FIELD CULTIVATOR

39.100.08 - DOUBLE FOLD INNER WING 38-1/2 THROUGH 50-1/2 MODELS

Ссылка	Кол-во	Номер по каталогу	Описание	OH	Индикаторы
1	1	86993793	TUBE ASSY. 7-1/2 Inner, Rh		
1	1	86993804	TUBE ASSY. 7-1/2 Inner, Lh		
1	1	86993840	TUBE ASSY. 9-1/2 Base, Rh		
1	1	86993842	TUBE ASSY. 9-1/2 Base, Lh		
2	1	86993806	TUBE ASSY. 9-1/2 Extension, Df, Rh		
2	1	86993808	TUBE ASSY. 9-1/2 Extension, Df, Lh		
3	1	06401100	ROCKSHAFT Rh Wing, Without Tandems		
3	1	87337198	ROCKSHAFT Rh Wing, With Tandems		
3	1	06401150	AXLE Lh Wing, Without Tandems		
3	1	87337200	ROCKSHAFT Lh Wing, With Tandems		
4	4	86993802	LUG Wing, 7-1/2		
4	4	86993848	TUBE ASSY. Wing, 9.5 And 7.5		
4	4	86993850	TUBE ASSY. Wing, 9.5 And 5.5		
5	4	86993810	LUG Cylinder, Df, Wing		
6	4	86993797	LUG Wing, 7-1/2		
6	4	86993845	LUG Mount, Truss, 9-1/2		
7	1	06400170	SCREW, ADJUSTMENT Depth Adjust, 1-1/2 Dia. Thread		
8	1	06400160	HANDLE, CRANKED Handle		
9	1	87413010	BAR ASSY. Outer Wing		
10	2	06401190	AXLE Rockshaft		
11	2	10008256	WHEEL, LAND 9.5L - 15SL, 8-Ply, Tubeless, Silver		
11	2	10008254	WHEEL, LAND 9.5L - 15SL, 8-Ply, Tube, Silver		
12	2	10108254	WHEEL 8 x 15, 6-Hole With Guard, Silver		
13	2	NSS	NOT SERVICED SEPARATELY 9.5 x 15, 8-Ply Tire, 1980928C1		
14	UAR	06400430	SPACER Cylinder		
15	2	44006200	BUSHING Painted		
16	2	06400140	TUBE Depth Adjust, 2-1/2 x 2-1/2		
20	6	16902025	SCREW 1-1/4 x 6.56, A-325, Hex		
21	UAR	14891660	PIN, SPECIAL 1 Dia. x 4.30		
22	2	14892076	PIN, SPECIAL 1-1/4 Dia. x 5-7/8		
23	2	14891630	PIN, SPECIAL 1 Dia. x 5-7/16		
24	1	25890100	KIT 1 Cylinder		
30	16	413-1056	BOLT Hex, 5/8"-11 x 3 1/2", G5,		
31	2	413-848	BOLT Hex, 1/2"-13 x 3", G5,		
32	4	413-844	BOLT Hex, 1/2"-13 x 2 3/4", G5,		
33	2	413-640	BOLT Hex, 3/8"-16 x 2 1/2", G5,		
34	12	413-1028	BOLT Hex, 5/8"-11 x 1 3/4", G5,		

200 : TIGER-MATE CASE IH FIELD CULTIVATOR

39.100.08 - DOUBLE FOLD INNER WING 38-1/2 THROUGH 50-1/2 MODELS

Ссылка	Кол-во	Номер по каталогу	Описание	ОН	Индикаторы
35	UAR	413-1072	BOLT Hex, 5/8"-11 x 4 1/2", G5,		 
36	UAR	88729	BOLT Hex, 5/8"-11 x 5", G5,		  
38	6	87613192	WASHER		
39	4	17618041	BUSHING, LARGE 1-1/8 Machine, 18 ga, ZP		
40	6	86992220	NUT, LOCK 1-1/4, Stover		
41	UAR	87374	WASHER 1", Standard, ZP		  
42	2	86992213	NUT, LOCK 3/8, NC, Stover		  
43	6	86992215	NUT, LOCK 1/2"-13, GC, Stover		  
45	2	25-1420	NUT Jam, 1 1/4"-7, G5,		
46	UAR	85700693	NUT, LOCK 5/8"-11, GC,		  
47	2	432-1632	PIN, SPLIT (COTTER) 1/4" x 2",		 
48	2	80299	WASHER 5/8", Standard, ZP		  
49	2	86993782	TUBE ASSY. Front, Corner, 42-1/2 Through 50-1/2 Models Only		
50	2	86993788	TUBE ASSY. Rear Corner		
51	UAR	413-1064	BOLT Hex, 5/8"-11 x 4", G5,		 
52	2	06250333	WASHER Backing		
53	2	219-87	NIPPLE, LUBE 1/4"-28 x .56" lg, Self-Tap,		  

200 : TIGER-MATE CASE IH FIELD CULTIVATOR

39.100.09 - DOUBLE FOLD OUTER WING 38-1/2 THROUGH 50-1/2 MODELS

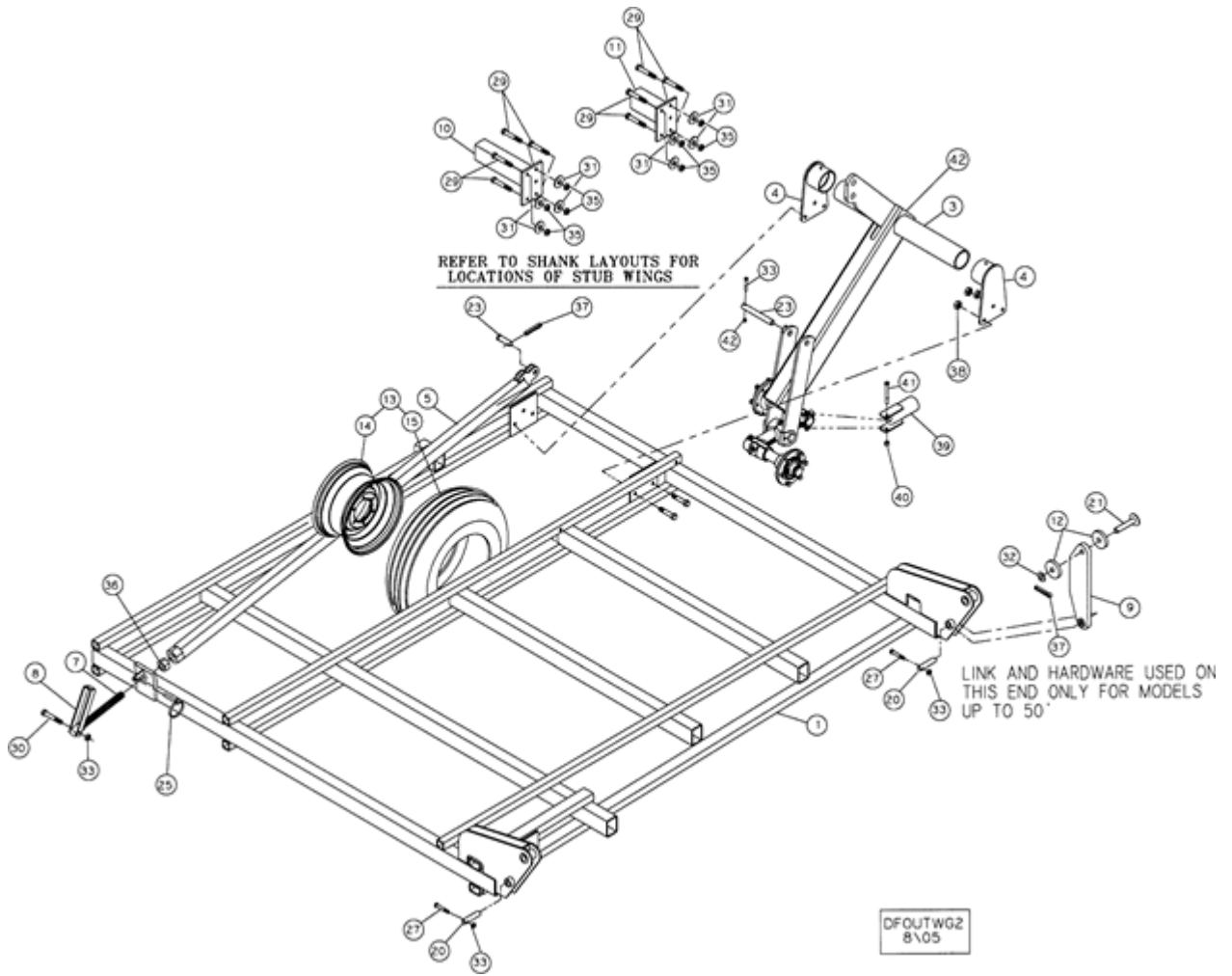











200 : TIGER-MATE CASE IH FIELD CULTIVATOR

39.100.09 - DOUBLE FOLD OUTER WING 38-1/2 THROUGH 50-1/2 MODELS

Ссылка	Кол-во	Номер по каталогу	Описание	ОН	Индикаторы
1	1	86993876	TUBE ASSY. Outer, 5-1/2, Rh, 42 Thru 50 Machines		
1	1	86993878	TUBE ASSY. Outer, 5-1/2, Lh, 42 Thru 50 Machines		
1	1	86993872	TUBE ASSY. Outer, 5-1/2, Rh, 2009 And After Models		
1	1	86993874	TUBE ASSY. Outer, 5-1/2, Lh, 2009 And After Models		
1	1	86993832	TUBE ASSY. Outer, 7-1/2, Rh		
1	1	86993834	TUBE ASSY. Outer, 7-1/2, Lh		
3	1	06401100	ROCKSHAFT Rh, Wing Without Tandem		
3	1	87337198	ROCKSHAFT Rh, Wing With Tandem		
3	1	06401150	AXLE Lh, Wing Without Tandem		
3	1	87337200	ROCKSHAFT Lh, Wing With Tandem		
4	4	06401190	AXLE Rockshaft		
5	2	06400820	STOP Depth Adjust, 2 x 2		
7	2	06400840	ADJUSTER Depth Adjust., Stamped 2 On End		
8	2	06400160	HANDLE, CRANKED Handle		
9	2	06402430	LINK Wing Fold		
10	2	86993855	TUBE ASSY. 15-1/2, Red		
11	2	86993852	TUBE ASSY. 9-1/2, Red		
12	4	06220844	ROLLER		
13	2	10008256	WHEEL, LAND 9.5L - 15SL, 8-Ply, Tubeless, Silver		
13	2	10008254	WHEEL, LAND 9.5L - 15SL, 8-Ply, Tube, Silver		
14	2	10108254	WHEEL 8 x 15, 6-Hole With Guard, Silver		
15	2	NSS	NOT SERVICED SEPARATELY 9.5 x 15, 8-Ply Tire, 1980928C1		
20	2	14891618	PIN, SPECIAL 1 Dia. x 4-1/2		
21	2	14891660	PIN, SPECIAL 1 Dia. x 4.30		
22	2	14891630	PIN, SPECIAL 1 Dia. x 5.75		
23	2	25890100	KIT 1, Cylinder		
25	2	D33805	PIN 7/16 x 2, Klik		
26	2	413-640	BOLT Hex, 3/8"-16 x 2 1/2", G5,		
27	2	413-840	BOLT Hex, 1/2"-13 x 2 1/2", G5,		
28	12	413-1028	BOLT Hex, 5/8"-11 x 1 3/4", G5,		
29	UAR	413-1056	BOLT Hex, 5/8"-11 x 3 1/2", G5,		
30	2	413-848	BOLT Hex, 1/2"-13 x 3", G5,		
31	UAR	87613192	WASHER		
32	2	87367	WASHER 1", SAE,		
33	UAR	86992213	NUT, LOCK 3/8, NC, Stover		
34	2	86992213	NUT, LOCK 3/8, NC, Stover		
35	UAR	85700693	NUT, LOCK 5/8"-11, GC,		

200 : TIGER-MATE CASE IH FIELD CULTIVATOR

39.100.09 - DOUBLE FOLD OUTER WING 38-1/2 THROUGH 50-1/2 MODELS

Ссылка	Кол-во	Номер по каталогу	Описание	ОН	Индикаторы
36	2	25-1420	NUT Jam, 1 1/4"-7, G5,		
37	2	432-1632	PIN, SPLIT (COTTER) 1/4" x 2",		 
39	1	87342062	WEIGHT, COUNTER Weight Wheel, Inc. 40 & 41, For Right Hand Walking Axle Only		
40	1	86992215	NUT, LOCK 1/2"-13, GC, Stover		  
41	1	413-872	BOLT Hex, 1/2"-13 x 4 1/2", G5,		
42	2	219-87	NIPPLE, LUBE 1/4"-28 x .56" lg, Self-Tap,		  

200 : TIGER-MATE CASE IH FIELD CULTIVATOR

39.100.10 - 54-1/2 TO 60-1/2 DOUBLE FOLD INNER WING

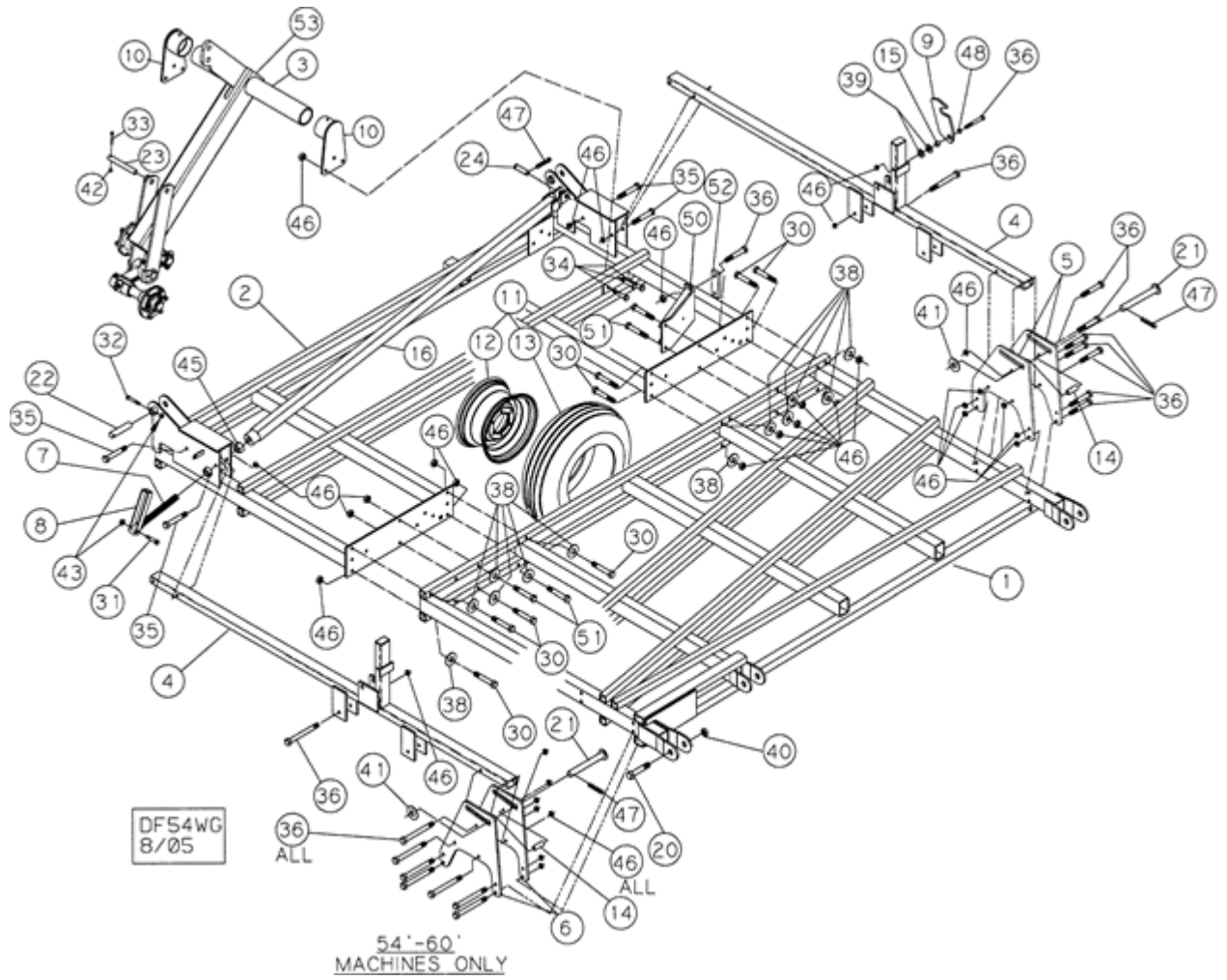

200 : TIGER-MATE CASE IH FIELD CULTIVATOR

39.100.10 - 54-1/2 TO 60-1/2 DOUBLE FOLD INNER WING

Ссылка	Кол-во	Номер по каталогу	Описание	OH	Индикаторы
1	1	86993859	TUBE ASSY. 11-1/2 Base, Df, Rh		
1	1	86993863	TUBE ASSY. 11-1/2 Base, Df, Lh		
2	1	86993814	TUBE ASSY. 11-1/2 Extension, Df, Rh		
2	1	86993816	TUBE ASSY. 11-1/2 Extension, Df, Lh		
3	1	06401100	ROCKSHAFT Rh Wing, Without Tandem		
3	1	87337198	ROCKSHAFT Rh Wing, With Tandem		
3	1	06401150	AXLE Lh Wing, Without Tandem		
3	1	87337200	ROCKSHAFT Lh Wing, With Tandem		
4	4	86993819	TUBE ASSY. 11-1/2 Extension		
5	4	86993810	LUG Cylinder, Df, Wing		
6	4	06401890W	BAR ASSY. Front Cylinder, Df, Wing, 54-1/2 Through 60-1/2 Models Only		
7	1	06400170	SCREW, ADJUSTMENT Depth Adjust, 1-1/4 Dia. Thread		
8	1	06400160	HANDLE, CRANKED Handle		
9	1	06401240	AXLE Outer Wing, 54-1/2 Models Only		
9	1	87413010	BAR ASSY. Outer Wing, 58-1/2 Through 60-1/2 Models Only		
10	2	06401190	AXLE Rockshaft		
11	2	10008256	WHEEL, LAND 9.5L - 15 SL, 8-Ply, Tubeless, Silver		
11	2	10008254	WHEEL, LAND 9.5L - 15 SL, 8-Ply, Tube, Silver		
12	2	10108254	WHEEL 8 x 15, 6-Hole With Guard, Silver		
13	2	NSS	NOT SERVICED SEPARATELY 9.5 x 15, 8-Ply Tire, 1980928C1, Used With Tube And Tubeless		
14	UAR	06400430	SPACER Cylinder Lug		
15	2	44006200	BUSHING Painted		
16	2	06400140	TUBE Depth Adjust, 2-1/2 x 2-1/2		
20	6	16902025	SCREW 1-1/4 x 6.56, A-325, Hex		
21	UAR	14891660	PIN, SPECIAL 1 Dia. x 4.30		
22	2	14892076	PIN, SPECIAL 1-1/4 Dia. x 5-7/8		
23	2	14891630	PIN, SPECIAL 1 Dia. x 5-7/16		
24	1	25890100	KIT 1, Cylinder		
30	16	413-1056	BOLT Hex, 5/8"-11 x 3 1/2", G5,		
31	2	413-848	BOLT Hex, 1/2"-13 x 3", G5,		

200 : TIGER-MATE CASE IH FIELD CULTIVATOR

39.100.10 - 54-1/2 TO 60-1/2 DOUBLE FOLD INNER WING

Ссылка	Кол-во	Номер по каталогу	Описание	ОН	Индикаторы
32	4	413-844	BOLT Hex, 1/2"-13 x 2 3/4", G5,		
33	2	413-640	BOLT Hex, 3/8"-16 x 2 1/2", G5,		
34	12	413-1028	BOLT Hex, 5/8"-11 x 1 3/4", G5,		
35	UAR	413-1072	BOLT Hex, 5/8"-11 x 4 1/2", G5,		
36	UAR	88729	BOLT Hex, 5/8"-11 x 5", G5,		
38	6	87613192	WASHER		
39	4	17618041	BUSHING, LARGE 1-1/8 Machine, 18 ga, ZP		
40	6	86992220	NUT, LOCK 1-1/4, Stover		
41	UAR	87374	WASHER 1", Standard, ZP		
42	2	86992213	NUT, LOCK 3/8, NC, Stover		
43	6	86992215	NUT, LOCK 1/2"-13, GC, Stover		
45	2	25-1420	NUT Jam, 1 1/4"-7, G5,		
46	UAR	85700693	NUT, LOCK 5/8"-11, GC,		
47	2	432-1632	PIN, SPLIT (COTTER) 1/4" x 2",		
48	2	80299	WASHER 5/8", Standard, ZP		
50	2	86993788	TUBE ASSY. Rear Corner, Used On 54-1/2 Through 60-1/2 Units		
51	UAR	413-1064	BOLT Hex, 5/8"-11 x 4", G5,		
52	1	06250333	WASHER Backing		
53	1	219-87	NIPPLE, LUBE 1/4"-28 x .56" lg, Self-Tap,		

200 : TIGER-MATE CASE IH FIELD CULTIVATOR

39.100.11 - 54-1/2 TO 60-1/2 DOUBLE FOLD OUTER WING

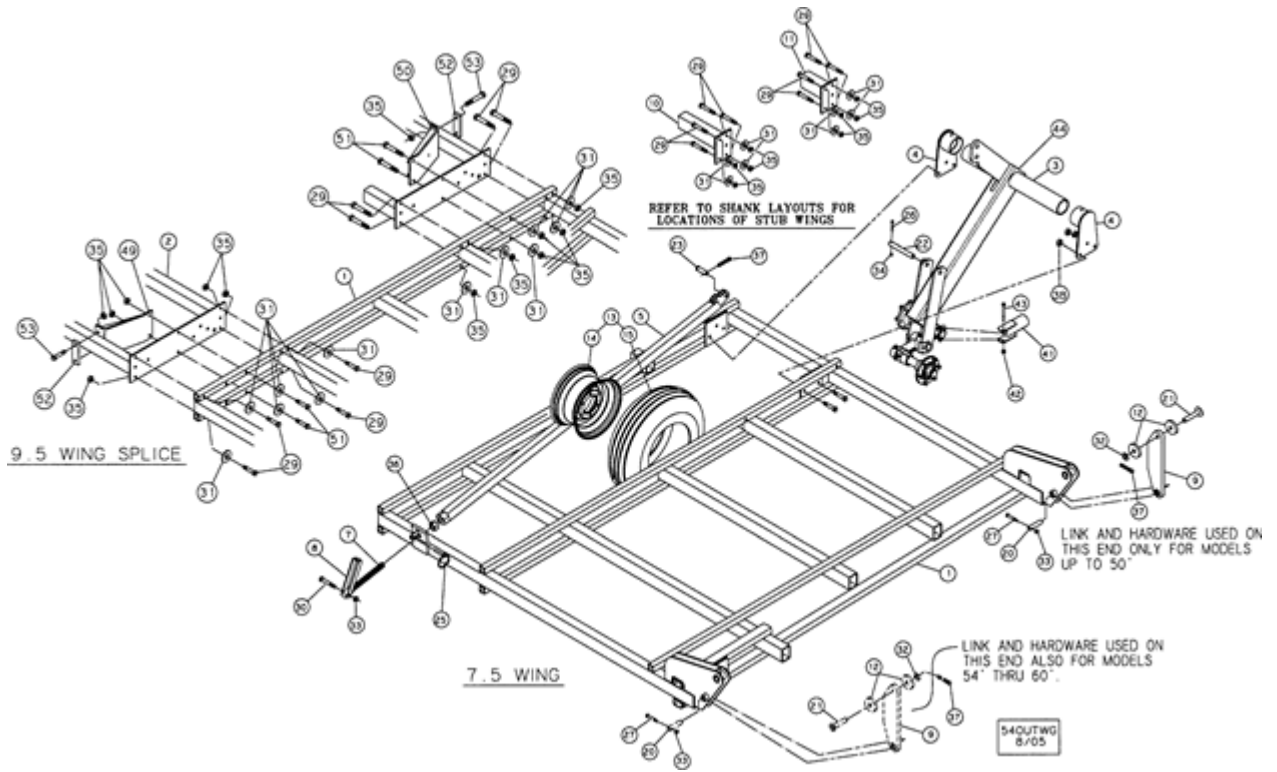



































200 : TIGER-MATE CASE IH FIELD CULTIVATOR

39.100.11 - 54-1/2 TO 60-1/2 DOUBLE FOLD OUTER WING

Ссылка	Кол-во	Номер по каталогу	Описание	ОН	Индикаторы
1	1	86993832	TUBE ASSY. Outer, 7-1/2, Rh		
1	1	86993834	TUBE ASSY. Outer, 7-1/2, Lh		
1	1	86993822	TUBE ASSY. Outer Base, 9-1/2, Rh		
1	1	86993824	TUBE ASSY. Outer Base, 9-1/2, Lh		
2	1	86993597	TUBE ASSY. Extension, 9-1/2, Rh		
2	1	86993601	TUBE ASSY. Extension, 9-1/2, Lh		
3	1	06401100	ROCKSHAFT Rh, Wing Without Tandem		
3	1	87337198	ROCKSHAFT Rh, Wing With Tandem		
3	1	06401150	AXLE Lh, Wing Without Tandem		
3	1	87337200	ROCKSHAFT Lh, Wing With Tandem		
4	4	06401190	AXLE Rockshaft		
5	2	06400820	STOP Depth Adjust, 2 x 2		
7	2	06400840	ADJUSTER Depth Adjust, 1-1/4 Dia. Thread, Stamped 2 On End		
8	2	06400160	HANDLE, CRANKED Handle		
9	2	06402430	LINK Wing Fold		
10	2	86993857	TUBE ASSY. 13-1/2		
11	2	86993852	TUBE ASSY. 9-1/2		
12	4	06220844	ROLLER		
13	2	10008256	WHEEL, LAND 9.5L - 15SL, 8-Ply, Tubeless, Silver		
13	2	10008254	WHEEL, LAND 9.5L - 15SL, 8-Ply, Tube, Silver		
14	2	10108254	WHEEL 8 x 15, 6-Hole With Guard, Silver		
15	2	NSS	NOT SERVICED SEPARATELY 9.5 x 15, 8-Ply Tire, 1980928C1, Tube and Tubeless		
20	2	14891618	PIN, SPECIAL 1 Dia. x 4-1/2		
21	2	14891660	PIN, SPECIAL 1 Dia. x 4.30		
22	2	14891630	PIN, SPECIAL 1 Dia. x 5.75		
23	2	25890100	KIT 1 Cylinder		
24	4	87629089	U-BOLT		
25	2	D33805	PIN 7/16 x 2, Klik		
26	2	413-640	BOLT Hex, 3/8"-16 x 2 1/2", G5,		
27	2	424-640	BOLT Hex, 3/8"-16 x 2 1/2", G2,		
28	12	413-1028	BOLT Hex, 5/8"-11 x 1 3/4", G5,		
29	UAR	413-1056	BOLT Hex, 5/8"-11 x 3 1/2", G5,		
30	2	413-848	BOLT Hex, 1/2"-13 x 3", G5,		
31	UAR	87613192	WASHER		
32	2	87367	WASHER 1", SAE,		

200 : TIGER-MATE CASE IH FIELD CULTIVATOR

39.100.11 - 54-1/2 TO 60-1/2 DOUBLE FOLD OUTER WING

Ссылка	Кол-во	Номер по каталогу	Описание	ОН	Индикаторы
33	UAR	86992215	NUT, LOCK 1/2"-13, GC, Stover		  
34	2	86992213	NUT, LOCK 3/8, NC, Stover		  
35	UAR	85700693	NUT, LOCK 5/8"-11, GC,		  
36	2	25-1420	NUT Jam, 1 1/4"-7, G5,		
37	2	432-1632	PIN, SPLIT (COTTER) 1/4" x 2",		  
38	2	86993782	TUBE ASSY. Front		
39	2	86993788	TUBE ASSY. Rear		
40	8	413-1064	BOLT Hex, 5/8"-11 x 4", G5,		  
41	1	87342062	WEIGHT, COUNTER Weight Wheel, Inc. 42 & 43		
42	1	86992215	NUT, LOCK 1/2"-13, GC, Stover		  
43	1	413-872	BOLT Hex, 1/2"-13 x 4 1/2", G5,		
44	2	219-87	NIPPLE, LUBE 1/4"-28 x .56" lg, Self-Tap,		   
49	2	86993782	TUBE ASSY. Front, Used On 58-1/2 Through 60-1/2 Units		
50	2	86993788	TUBE ASSY. Rear, Used On 58-1/2 Through 60-1/2 Units		
51	UAR	413-1064	BOLT Hex, 5/8"-11 x 4", G5,		  
52	2	06250333	WASHER Backing		
53	UAR	88729	BOLT Hex, 5/8"-11 x 5", G5,		 

200 : TIGER-MATE CASE IH FIELD CULTIVATOR



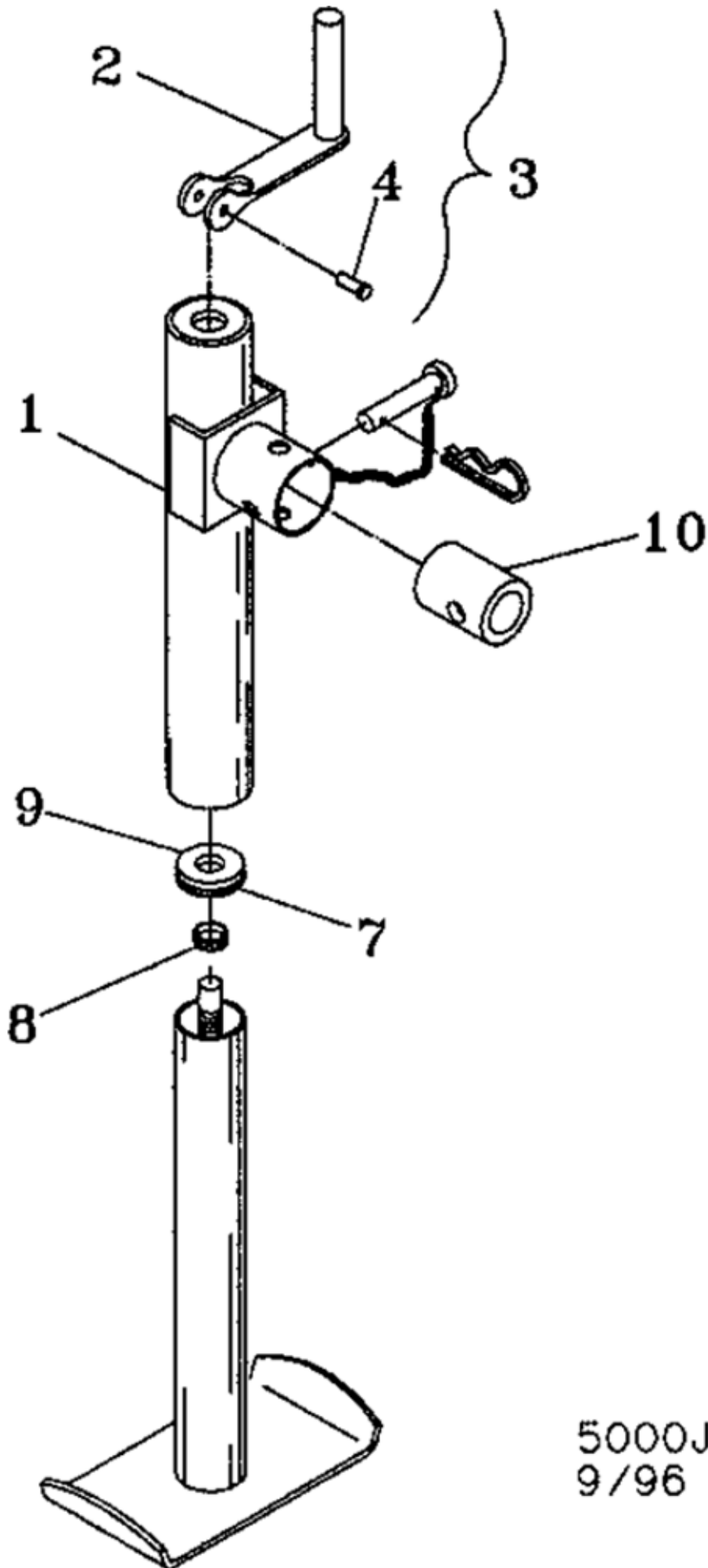





39.110.01 - JACK



5000JK
9/96

200 : TIGER-MATE CASE IH FIELD CULTIVATOR

39.110.01 - JACK

Ссылка	Кол-во	Номер по каталогу	Описание	ОН	Индикаторы
1	1	32252000	JACK ASSY. 5000#		
2	1	NSS	NOT SERVICED SEPARATELY Handle		
3	1	NSS	NOT SERVICED SEPARATELY Handle Replacement, Inc. 2, 4 - 5		
4	1	NSS	NOT SERVICED SEPARATELY 1/4 x 1 Standard Bolt		
5	1	NSS	NOT SERVICED SEPARATELY 1/4 Lock Nut		
7	7	NSS	NOT SERVICED SEPARATELY Thrust Washer		
8	2	NSS	NOT SERVICED SEPARATELY Felt Washer		
9	1	NSS	NOT SERVICED SEPARATELY Thrust Bearing		
10	1	06400808	JACK ASSY. Mounting		





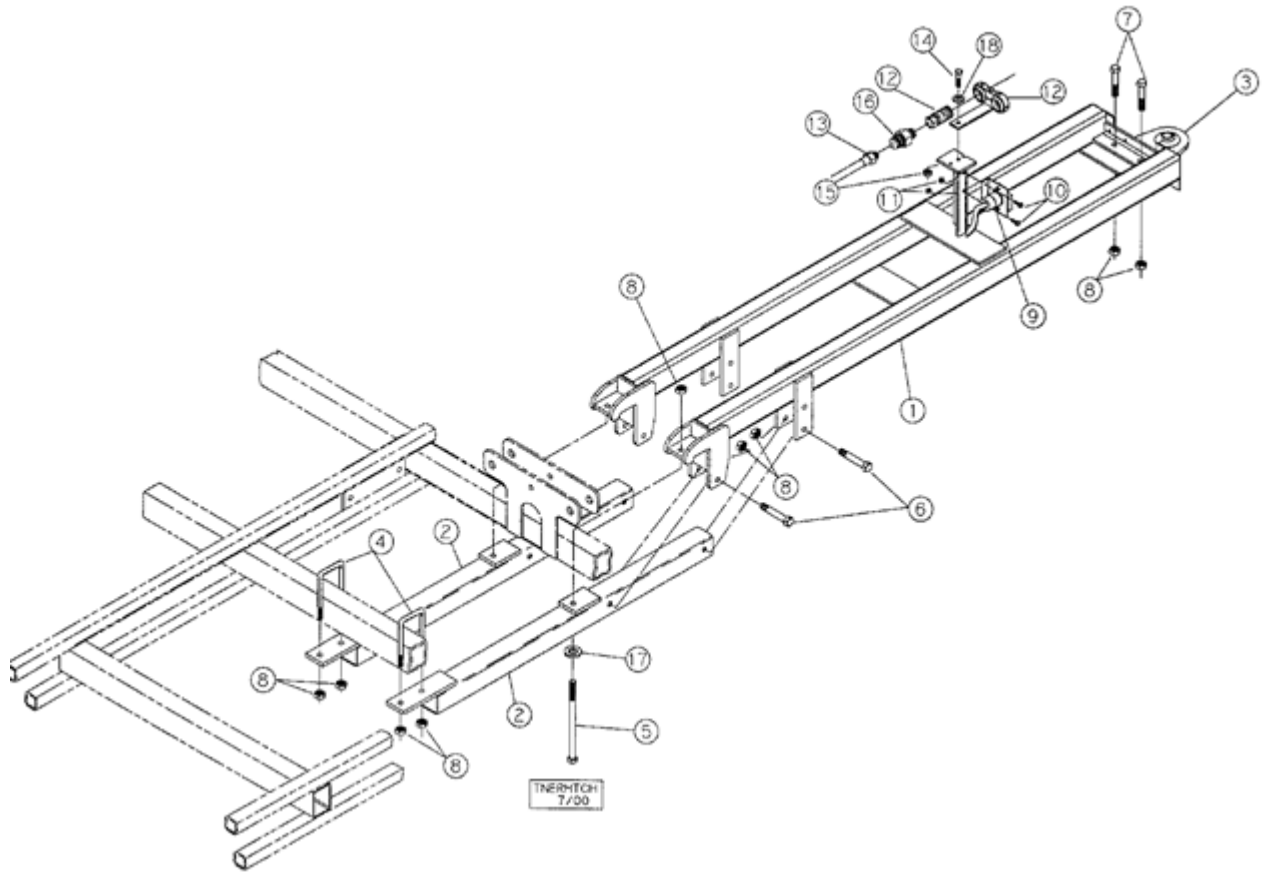

























200 : TIGER-MATE CASE IH FIELD CULTIVATOR

39.110.02 - TIGER TINE REAR HITCH ATTACHMENT



200 : TIGER-MATE CASE IH FIELD CULTIVATOR

39.110.02 - TIGER TINE REAR HITCH ATTACHMENT

Ссылка	Кол-во	Номер по каталогу	Описание	ОН	Индикаторы
1	1	06402950	ANGLE Rear, Tiger Tine		
2	2	06402910	BAR ASSY. Support		
3	1	06402935	PLATE Hitch		
4	2	87629102	U-BOLT		
5	2	413-10152	BOLT Hex, 5/8"-11 x 9 1/2", G5,		 
6	4	88729	BOLT Hex, 5/8"-11 x 5", G5,		 
7	2	413-1032	BOLT Hex, 5/8"-11 x 2", G5,		 
8	12	85700693	NUT, LOCK 5/8"-11, GC,		 
9	1	87446783	HARNES, WIRE 4 Pin Connector, 2006 And Prior Models, BSN JFH0034721		
9	1	87611500	HARNES, WIRE 6 Pin Connector, 2007 And After Models, ASN JFH0034722		
10	2	413-412	BOLT Hex, 1/4"-20 x 3/4", G5, Full Thd,		  
11	2	86992211	NUT, LOCK 1/4, NC		 
12	1	25705020	COUPLING, QUICK, FEMALE Quic-Couple		
13	2	1284366C1	HOSE 1/4 x 100		
14	1	413-624	BOLT Hex, 3/8"-16 x 1 1/2", G5,		  
15	1	86992213	NUT, LOCK 3/8, NC, Stover		 
16	2	218-5058	CONNECTOR, HYD. 9/16"-18, 37° x 3/4"-18, O-Ring,		 
17	2	87613192	WASHER		
18	1	80702	WASHER 3/8",		   
19	1	P1640350	HITCH ASSY Hitch Complete		





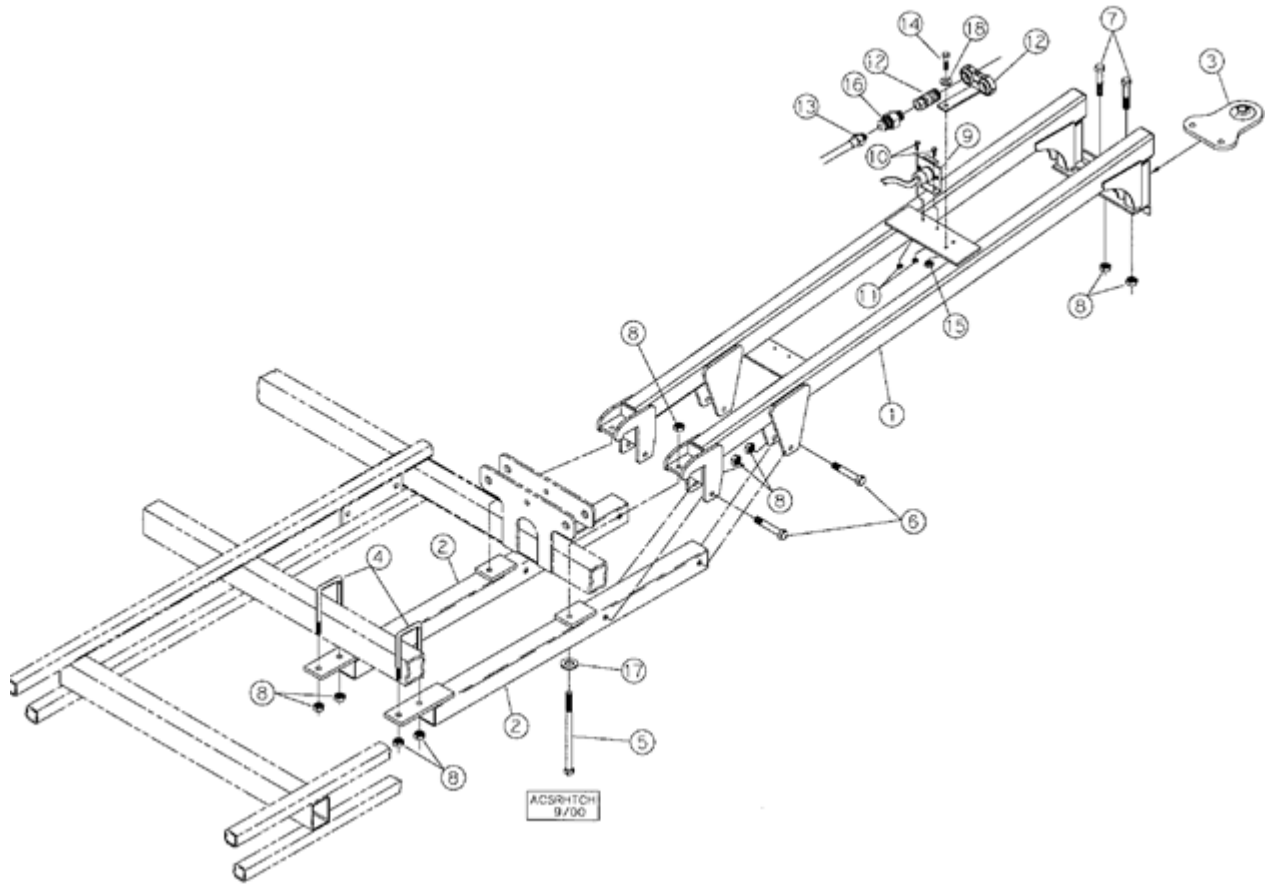



























200 : TIGER-MATE CASE IH FIELD CULTIVATOR

39.110.03 - ACS REAR HITCH ATTACHMENT



200 : TIGER-MATE CASE IH FIELD CULTIVATOR

39.110.03 - ACS REAR HITCH ATTACHMENT

Ссылка	Кол-во	Номер по каталогу	Описание	ОН	Индикаторы
1	1	06402980	ANGLE Rear		
2	2	06402910	BAR ASSY. Support		
3	1	06402935	PLATE Hitch		
4	2	87629102	U-BOLT		
5	2	413-10152	BOLT Hex, 5/8"-11 x 9 1/2", G5,		 
6	4	88729	BOLT Hex, 5/8"-11 x 5", G5,		 
7	2	413-1032	BOLT Hex, 5/8"-11 x 2", G5,		  
8	12	85700693	NUT, LOCK 5/8"-11, GC,		 
9	1	87446783	HARNESS, WIRE 4 Pin Connector, 2006 And Prior Models, BSN JFH0034721		
9	1	87611500	HARNESS, WIRE 6 Pin Connector, 2007 And After Models, ASN JFH0034722		
10	2	413-412	BOLT Hex, 1/4"-20 x 3/4", G5, Full Thd,		  
11	2	86992211	NUT, LOCK 1/4, NC		 
12	1	25705021	COUPLING Female		
12	1	25705012	COUPLING Breakaway Frame		
13	2	1284366C1	HOSE 1/4 x 100		
14	1	413-624	BOLT Hex, 3/8"-16 x 1 1/2", G5,		  
15	1	86992213	NUT, LOCK 3/8, NC, Stover		 
16	2	218-5058	CONNECTOR, HYD. 9/16"-18, 37° x 3/4"-18, O-Ring,		 
17	2	87613192	WASHER		
18	1	80702	WASHER 3/8",		   
19	1	P1640400	HITCH ASSY Acs Attachment Complete		

200 : TIGER-MATE CASE IH FIELD CULTIVATOR

44.100.01 - SINGLE FOLD MAIN FRAME

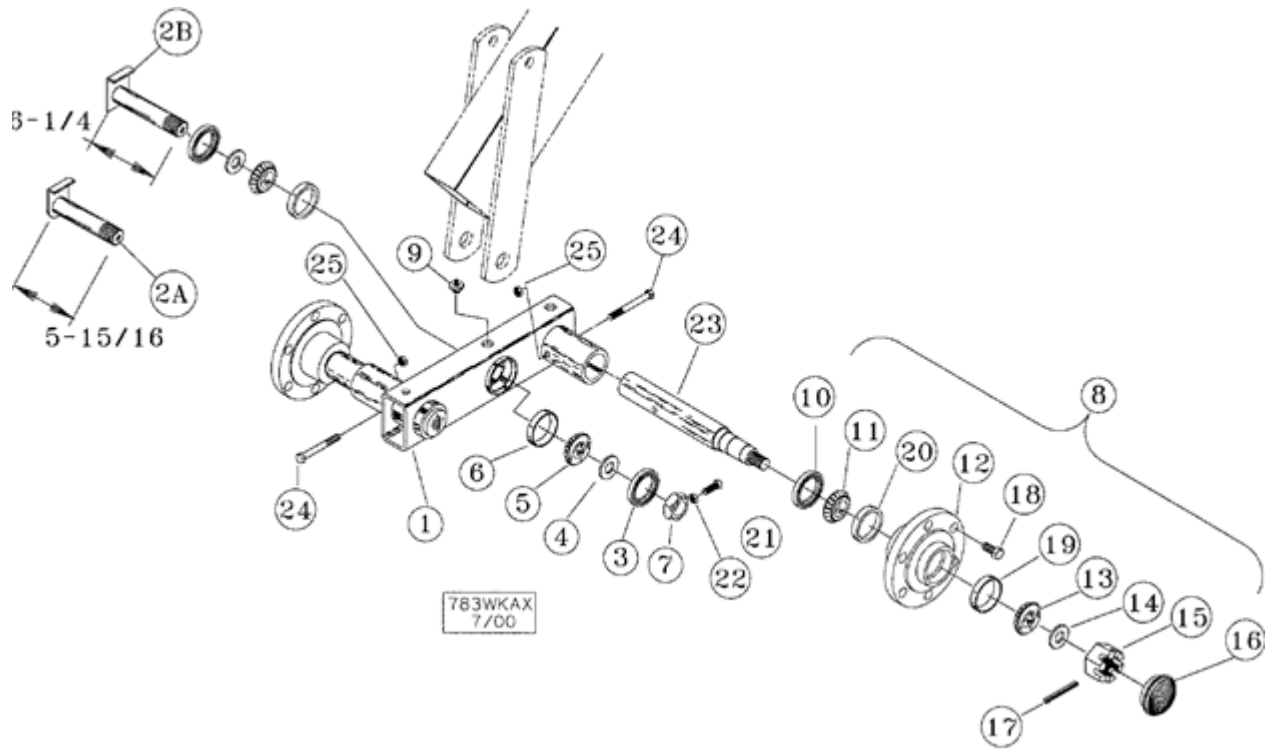

200 : TIGER-MATE CASE IH FIELD CULTIVATOR

44.100.01 - SINGLE FOLD MAIN FRAME

Ссылка	Кол-во	Номер по каталогу	Описание	ОН	Индикаторы
1	1	06400450	TUBE ASSY. Rh		
1	1	06400470	TUBE ASSY. Lh		
2A	1	06400290	PIN, SPECIAL Axle, 10 And 12 Mainframe And Wings		
2B	1	04661850	PIN Axle, 14 Single Fold Mainframe		
3	2	21932090	SEAL, OIL 2.094 Bore, CR#20952		
4	2	06201425	SPACER		
5	2	160558C91	BEARING, CONE 1.50, Timken #LM29749		
6	2	478793R1	BEARING SET 2.56 OD, Timken #LM29710		
7	1	14032409	NUT, SPECIAL 1-1/2, Jam		
8	2	28178300	HUB ASSY. 783, 6-Bolt		
9	1	219-86	NIPPLE, LUBE 1/8" x .62" lg, Drive, Self Tap		
10	1	145769C91	SEAL 1.875 ID x 3.005 OD, CR# 18823		
11	1	663557R91	BEARING, CONE 1.624 Bore, Timken #LM501349		
12	1	28278300	HUB		
13	1	651818R91	BEARING, CONE 1.25 Bore, Timken #LM67048		
14	1	495-61094	WASHER 7/8" x 2 1/4" x .16",		
15	1	425-1314	NUT, SLOTTED 7/8"-14, G5,		
16	1	28477700	HUB CAP		
17	1	432-1024	PIN, SPLIT (COTTER) 5/32" x 1 1/2",		
18	6	549962R1	BOLT 1/2, NF x 1-15/32 Lug		
19	1	651817R1	BEARING, CUP 2.33 OD, Timken #LM67010		
20	1	663558R1	BEARING, CUP 2.89 OD, Timken #LM501310		
21	1	16806045	SCREW 3/8 x 1, Square Head		
22	1	425-146	NUT Jam, 3/8"-16, G5,		
23	2	28378351	SPINDLE 783 - 1-7/8		
23	2	87327557	SPINDLE 783 - 1.875		
24	2	413-852	BOLT Hex, 1/2"-13 x 3 1/4", G5,		
25	2	86992215	NUT, LOCK 1/2"-13, GC, Stover, Timken #LM501349		





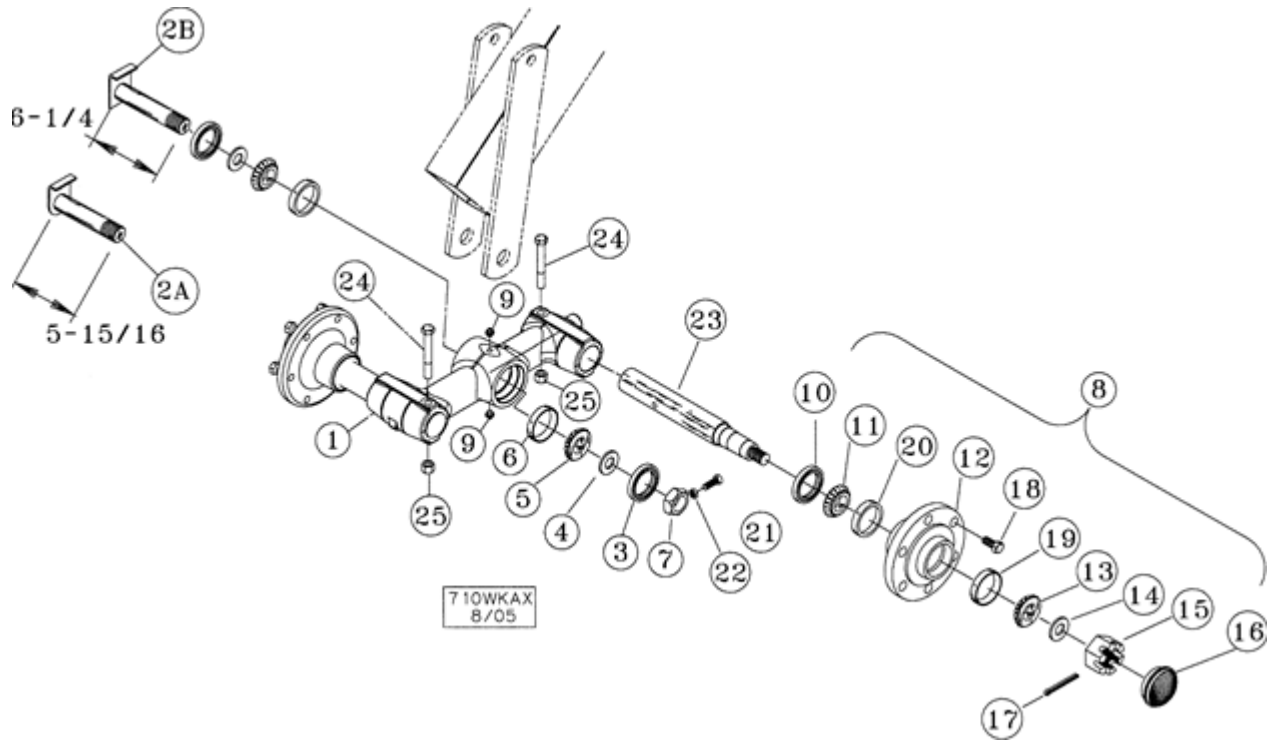









































200 : TIGER-MATE CASE IH FIELD CULTIVATOR

44.100.02 - SINGLE FOLD WING AND 710 WALKING AXLE



200 : TIGER-MATE CASE IH FIELD CULTIVATOR

44.100.02 - SINGLE FOLD WING AND 710 WALKING AXLE

Ссылка	Кол-во	Номер по каталогу	Описание	ОН	Индикаторы
1	2	87459650	AXLE Walking Tandem With Cups		
2A	1	06400290	PIN, SPECIAL Axle, 5-5-16, 10 And 12 Mainframe and Wings		
2B	1	04661850	PIN Axle, 6-1/4, 14 Mainframe		
3	2	21932090	SEAL, OIL 2.094 Bore, CR20952		
4	2	06201425	SPACER		
5	2	160558C91	BEARING, CONE 1.50, Timken LM29749		 
6	2	478793R1	BEARING SET 2.56 OD, Timken LM29710		 
7	1	14032409	NUT, SPECIAL 1-1/2, Jam		
8	2	87327566	SPINDLE 710, 6 Bolt		
9	2	219-86	NIPPLE, LUBE 1/8" x .62" lg, Drive, Self Tap		  
10	1	614410R91	SEAL 1.625 ID x 2.63 OD, CR 163221		
11	1	618023R91	BEARING, CONE 1.375 Bore, Timken LM48548		  
12	1	28270900	HUB ASSY. W709		
13	1	651818R91	BEARING, CONE 1.25 Bore, Timken LM67048		  
14	2	87716935	WASHER		
15	1	425-1314	NUT, SLOTTED 7/8"-14, G5,		 
16	1	28477700	HUB CAP		
17	1	432-1024	PIN, SPLIT (COTTER) 5/32" x 1 1/2",		 
18	6	549962R1	BOLT 1/2, NF x 1-15/32		  
19	1	651817R1	BEARING, CUP 2.33 OD, Timken LM67010		  
20	1	618024R1	BEARING, CUP 2.56 OD, Timken LM48510		  
21	1	16806045	SCREW 3/8 x 1, Square Head		
22	1	425-146	NUT Jam, 3/8"-16, G5,		   
23	2	87327569	STUB AXLE/STRG.SPINDLE 710, 1-7/8		
24	2	413-860	BOLT Hex, 1/2"-13 x 3 3/4", G5,		  
25	2	86992215	NUT, LOCK 1/2"-13, GC, Stover		  





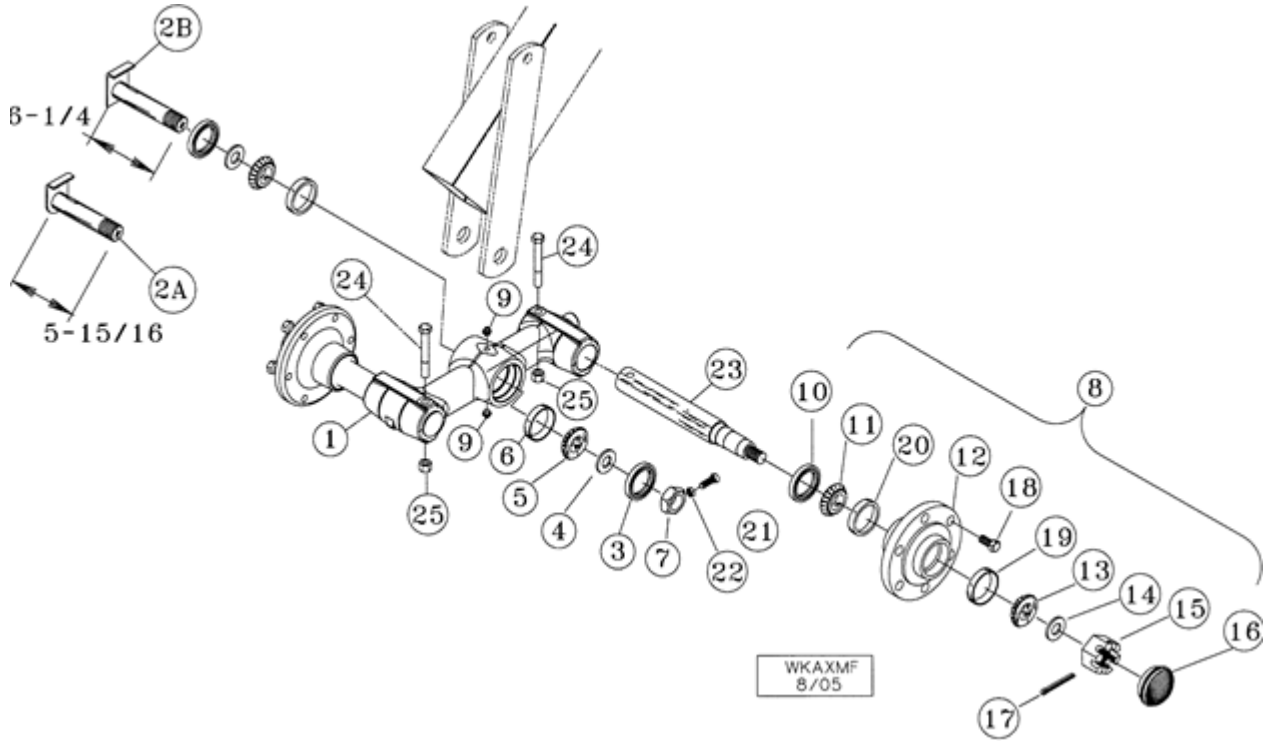



































200 : TIGER-MATE CASE IH FIELD CULTIVATOR

44.100.03 - DOUBLE FOLD WALKING AXLE ASSEMBLY 38-1/2 THROUGH 46-1/2



200 : TIGER-MATE CASE IH FIELD CULTIVATOR

44.100.03 - DOUBLE FOLD WALKING AXLE ASSEMBLY 38-1/2 THROUGH 46-1/2

Ссылка	Кол-во	Номер по каталогу	Описание	ОН	Индикаторы
1	2	87366225	CASTING Walking Tandem With Cups, 50-8		
2	1	04661850	PIN 6-1/4		
3	2	21932510	SEAL 2.29, CR#22870		
4	2	06400573	SPACER		
5	2	21871501	BEARING, CONE 1.50 Bore, Timken #2776		
6	2	17498D	BEARING, CUP 3.00 OD, Timken #2720		 
7	1	14032409	NUT, SPECIAL 1-1/2, Jam		
8	2	28150800	HUB ASSY. 50-8, 8-Bolt		
9	1	219-86	NIPPLE, LUBE 1/8" x .62" lg, Drive, Self Tap		  
10	1	21932502	SEAL, OIL 2-1/2 ID x 3.256 OD, CR# 24924		
11	1	21872005	BEARING, CONE 2 Bore, Timken #LM104948		
12	1	28250800	HUB ASSY. 50-8		
13	1	663557R91	BEARING, CONE 1.625 Bore, Timken #LM501349		  
14	1	17916100	WASHER, SPECIAL 1, Special		 
15	1	427652	NUT, SLOTTED 1"-14, G5,		 
16	1	28460800	DUST CAP		
17	1	432-1232	PIN, SPLIT (COTTER) 3/16" x 2",		  
18	8	554480R1	NUT 5/8, NF, Wheel		 
19	1	663558R1	BEARING, CUP 2.89 OD, Timken #LM501310		  
20	1	376463C1	BEARING, ROLLER, TAPERED 3.228 OD, Timken #JLM104910		 
21	1	16806045	SCREW 3/8 x 1, Square Head Set		
22	1	425-146	NUT Jam, 3/8"-16, G5,		   
23	2	87327585	SPINDLE 2-1/2, 50-8		
24	2	413-872	BOLT Hex, 1/2"-13 x 4 1/2", G5,		
25	2	86992215	NUT, LOCK 1/2"-13, GC, Stover		  

200 : TIGER-MATE CASE IH FIELD CULTIVATOR

44.100.04 - DOUBLE FOLD WALKING AXLE 38-1/2 - 60-1/2 2005 AND PRIOR UNITS

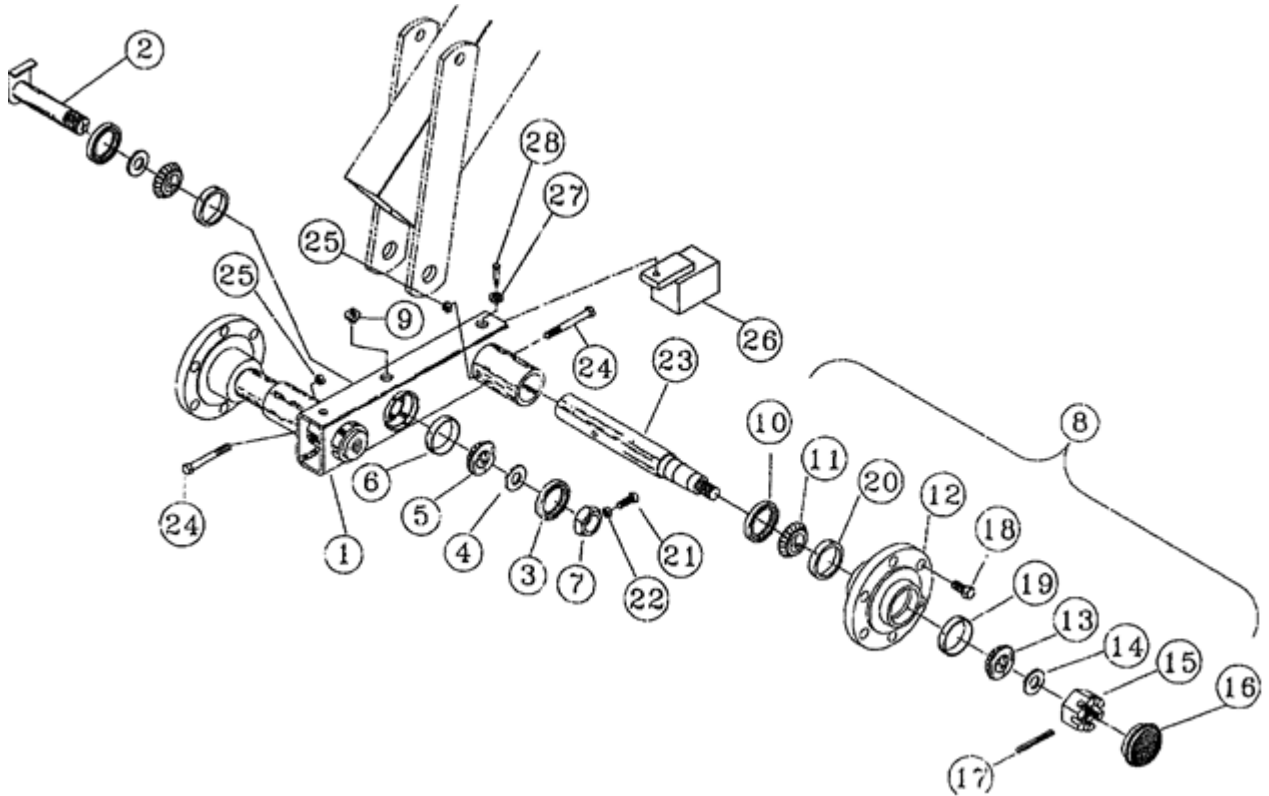

200 : TIGER-MATE CASE IH FIELD CULTIVATOR

44.100.04 - DOUBLE FOLD WALKING AXLE 38-1/2 - 60-1/2 2005 AND PRIOR UNITS

Ссылка	Кол-во	Номер по каталогу	Описание	ОН	Индикаторы
1	1	06400450	TUBE ASSY. Walking Axle, Rh, Wing Only		
1	1	06400470	TUBE ASSY. Walking Axle, Lh, Wing Only		
1	1	06400870	TUBE ASSY. Walking Axle, Rh, Main Frame		
1	1	06400880	BEAM Walking Axle, Lh, Main Frame		
2	1	06400290	PIN, SPECIAL 5-15 - 15 Long, Wing Only		
2	1	04661850	PIN 6-1/4 Long, Main Frame		
3	2	21932090	SEAL, OIL 2.094, CR20952, Wing Only		
3	2	21932510	SEAL 3.148, CR22870, Main Frame		
4	2	06201425	SPACER Wing Only		
4	2	06400573	SPACER Main Frame		
5	2	21871500	BEARING, CONE 1.50, Timken LM29749, Wing Only		
5	2	21871501	BEARING, CONE 1.50, Timken 2776, Main Frame		
6	2	21882561	BEARING SET 2.56 OD Cup, Timken LM9710, Wing Only		
6	2	21883000	BEARING SET 3.00 OD Cup, Timken 2720, Main Frame		
7	1	14032409	NUT, SPECIAL 1-1/2 Special Jam Nut		
8	2	28178300	HUB ASSY. 783, 6-Bolt, Wing Only		
8	2	28150800	HUB ASSY. 50-8, 8 Bolt, Main Frame		
9	1	15302005	FITTING 1/8 NPT Self Tap Zerk		
10	1	21931870	SEAL, SHAFT 1.875 ID x 3.005 OD, CR18823, Wing Only		
10	1	21932502	SEAL, OIL 2-1/2 ID x 3.256 OD, CR24924, Main Frame		
11	1	21871630	BEARING, CONE 1.624, Timken LM501349		
12	1	28278300	HUB 783 With Cups, Wings Only		
12	1	28250800	HUB ASSY. 50-8 With Cups, Main Frame		
13	1	21871250	BEARING, CONE 1.25, Timken LM67048, Wings Only		
13	1	21872005	BEARING, CONE 2, Timken LM104948, Main Frame		
14	1	17014002	WASHER 7/8, 2 OD, Wings Only		
14	1	17916100	WASHER, SPECIAL 1, Main Frame		
15	1	14051402	NUT, SLOTTED 7/8 NF, Wings Only		

200 : TIGER-MATE CASE IH FIELD CULTIVATOR

44.100.04 - DOUBLE FOLD WALKING AXLE 38-1/2 - 60-1/2 2005 AND PRIOR UNITS

Ссылка	Кол-во	Номер по каталогу	Описание	ОН	Индикаторы
15	1	14051603	NUT 1 NF, Slotted, Main Frame		→
16	1	28477700	HUB CAP Wings Only		←
16	1	28460800	DUST CAP Main Frame		→
17	1	14700502	PIN, SPLIT (COTTER) 5/32 x 1-1/2, Wings Only		→
17	1	14700600	PIN, SPLIT (COTTER) 3/16 x 2, Main Frame		→
18	6	16408053	BOLT, SPECIAL 1/2 NF x 1-15/32 Lug, Wings Only		→
18	8	14081003	NUT 5/8 NF, Main Frame		→
19	1	21882330	BEARING SET 2.33 OD, Timken LM67010, Wings Only		→
19	1	21882890	BEARING SET 2.89 OD, Timken LM501310, Main Frame		→
20	1	21882890	BEARING SET 2.89 OD, Timken LM501310, Wings Only		→
20	1	21883265	BEARING SET 3.228 OD, Timken JLM104910, Main Frame		→
21	1	16806045	SCREW 3/8 x 1, Square Head Set		←
22	1	14030601	NUT 3/8 NC, Jam		
23	2	28378350	AXLE SHAFT 783 - 1-7/8 Spindle, Wings Only		→
23	2	28350832	SPINDLE 2-1/2, 12 Main Frame		
23	2	28350821	SPINDLE 2-1/2, 14 Main Frame		
24	2	16008135	BOLT 1/2 x 3-1/4 NC, Hex, GD 5, Wings Only		→
24	2	16008165	SCREW 1/2 x 4 NC, Hex, GD 5, Main Frame		→
25	2	14110801	NUT 1/2 NC, Stover Lock		→
26	1	06406140	BRACKET Wheel Weight, 38-44 Units Only, Wings Only		
27	1	17210001	WASHER, LOCK 5/8, Wings Only		→
28	1	413-1020	BOLT Hex, 5/8"-11 x 1 1/4", G5, Full Thd, Wings Only		←→





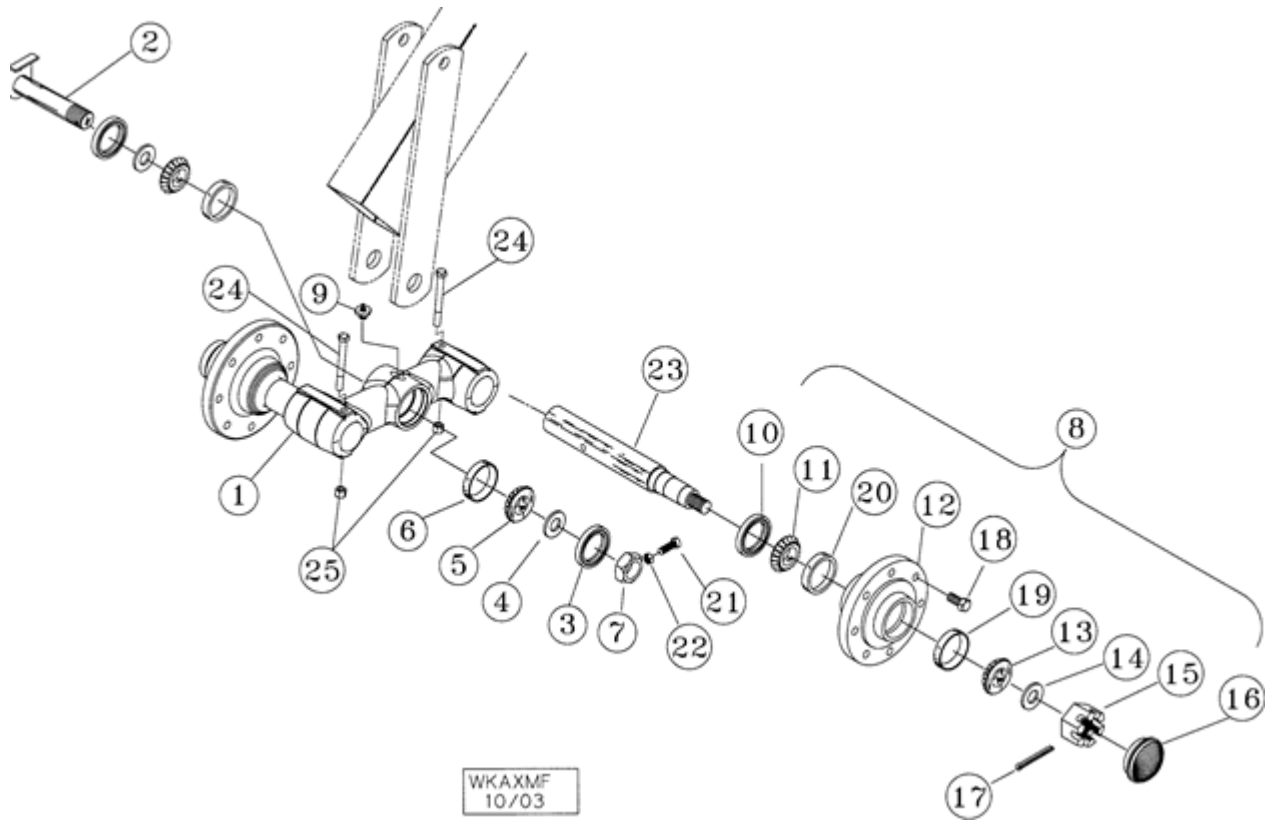







































200 : TIGER-MATE CASE IH FIELD CULTIVATOR

44.100.05 - DOUBLE FOLD WALKING AXLE ASSEMBLY 48-1/2 MAINFRAME ONL...



200 : TIGER-MATE CASE IH FIELD CULTIVATOR

44.100.05 - DOUBLE FOLD WALKING AXLE ASSEMBLY 48-1/2 MAINFRAME ONL...

Ссылка	Кол-во	Номер по каталогу	Описание	ОН	Индикаторы
1	2	87366231	CASTING Walking Tandem With Cups, 60-8		
2	1	04661850	PIN Axle, 6-1/4		
3	2	21932510	SEAL 2.29, CR#22870		
4	2	06400573	SPACER		
5	2	21871501	BEARING, CONE 1.50 Bore, Timken #2776		
6	2	17498D	BEARING, CUP 3.00 OD, Timken #2720		 
7	1	14032409	NUT, SPECIAL 1-1/2, Jam		
8	2	28660800	HUB ASSY. 60-8B, 8-Bolt		
9	1	219-86	NIPPLE, LUBE 1/8" x .62" lg, Drive, Self Tap		  
10	1	21932750	SEAL, OIL 2.75 ID x 3.75 OD, CR#531108		 
11	1	3216619R91	BEARING, ROLLER 2.164 Bore, Timken #JLM506848		 
12	1	28760800	HUB ASSY. 60-8B		
13	1	663557R91	BEARING, CONE 1.625 Bore, Timken #JLM501349		  
14	1	17916100	WASHER, SPECIAL 1, Special		 
15	1	427652	NUT, SLOTTED 1"-14, G5, 1, NF, Slotted		 
16	1	28460800	DUST CAP		
17	1	432-1232	PIN, SPLIT (COTTER) 3/16" x 2",		  
18	8	366021R2	BOLT 5/8 x 2-1/4, NF		 
18	8	554480R1	NUT 5/8, NF, Wheel		 
19	1	663558R1	BEARING, CUP 2.89 OD, Timken #LM501310		  
20	1	625743C1	BEARING, CUP 3.54 OD, Timken #JLM506810		  
21	1	16806045	SCREW 3/8 x 1, Square Head Set		
22	1	425-146	NUT Jam, 3/8"-16, G5,		   
23	2	87328351	SPINDLE 2-3/4, 60-8		
24	2	413-872	BOLT Hex, 1/2"-13 x 4 1/2", G5,		
25	2	86992215	NUT, LOCK 1/2"-13, GC, Stover		  

200 : TIGER-MATE CASE IH FIELD CULTIVATOR

44.100.06 - DOUBLE FOLD WALKING AXLE ASSEMBLY (MAINFRAME ONLY) 54-1/2 T...

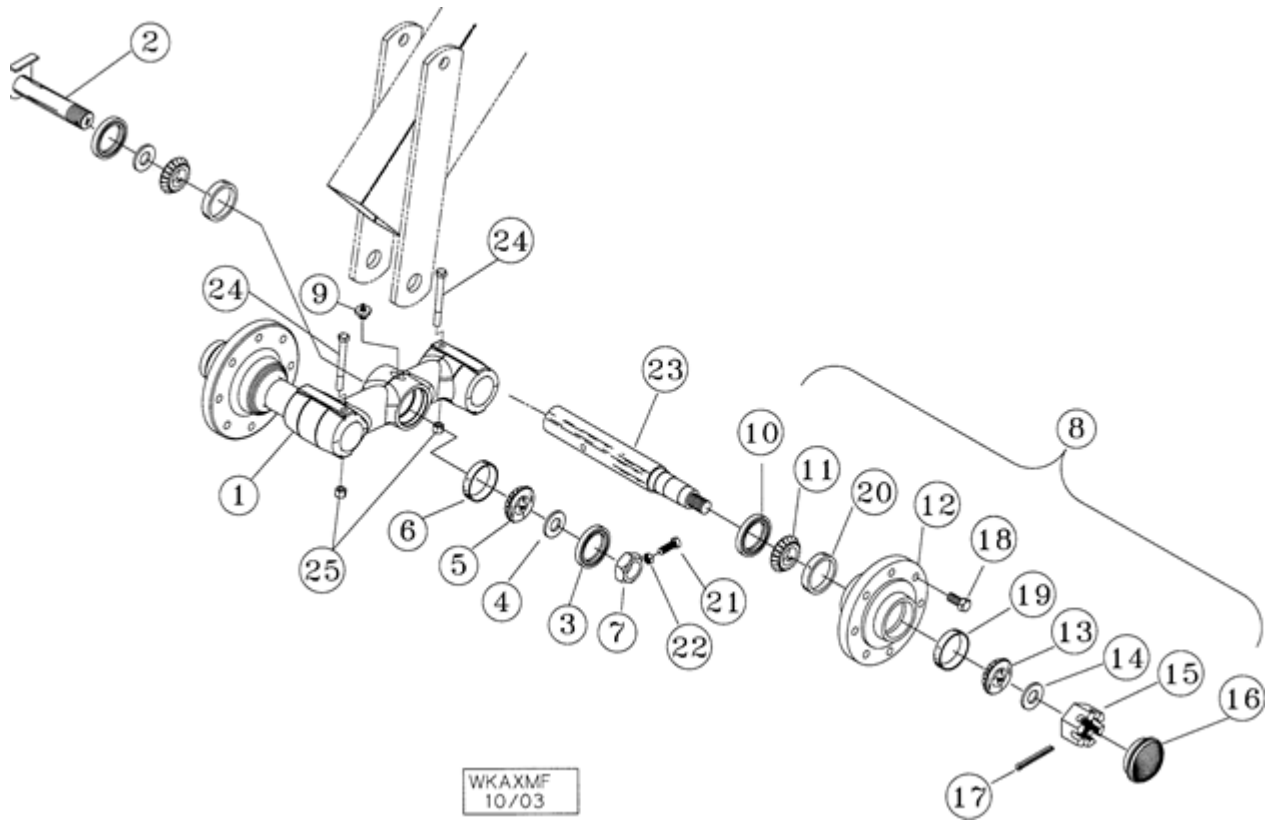

200 : TIGER-MATE CASE IH FIELD CULTIVATOR

44.100.06 - DOUBLE FOLD WALKING AXLE ASSEMBLY (MAINFRAME ONLY) 54-1/2 T...

Ссылка	Кол-во	Номер по каталогу	Описание	ОН	Индикаторы
1	2	87366231	CASTING Walking Tandem With Cups, 60-8		
2	1	04661850	PIN Axle, 6-1/4		
3	2	21932510	SEAL 2.29, CR#22870		
4	2	06400573	SPACER		
5	2	21871501	BEARING, CONE 1.50 Bore, Timken #2776		
6	2	17498D	BEARING, CUP 3.00 OD, Timken #2720		
7	1	14032409	NUT, SPECIAL 1-1/2, Jam		
8	2	28660800	HUB ASSY. 60-8B, 8-Bolt		
9	1	219-86	NIPPLE, LUBE 1/8" x .62" lg, Drive,		
10	1	21932750	SEAL, OIL 2.75 ID x 3.75 OD, CR#531108		
11	1	3216619R91	BEARING, ROLLER 2.164 Bore, Timken #JLM506848		
12	1	28760800	HUB ASSY. 60-8B		
13	1	663557R91	BEARING, CONE 1.625 Bore, Timken #JLM501349		
14	1	17916100	WASHER, SPECIAL 1		
15	1	427652	NUT, SLOTTED 1"-14, G5,		
16	1	28460800	DUST CAP		
17	1	432-1232	PIN, SPLIT (COTTER) 3/16" x 2",		
18	8	366021R2	BOLT 5/8 x 2-1/4, NF		
18	8	554480R1	NUT 5/8, NF, Wheel		
19	1	663558R1	BEARING, CUP 2.89 OD, Timken #LM501310		
20	1	625743C1	BEARING, CUP 3.54 OD, Timken #JLM506810		
21	1	16806045	SCREW 3/8 x 1, Square Head Set		
22	1	425-146	NUT Jam, 3/8"-16, G5,		
23	2	87328351	SPINDLE 2-3/4, 60-8		
24	2	413-872	BOLT Hex, 1/2"-13 x 4 1/2", G5,		
25	2	86992215	NUT, LOCK 1/2"-13, GC, Stover		





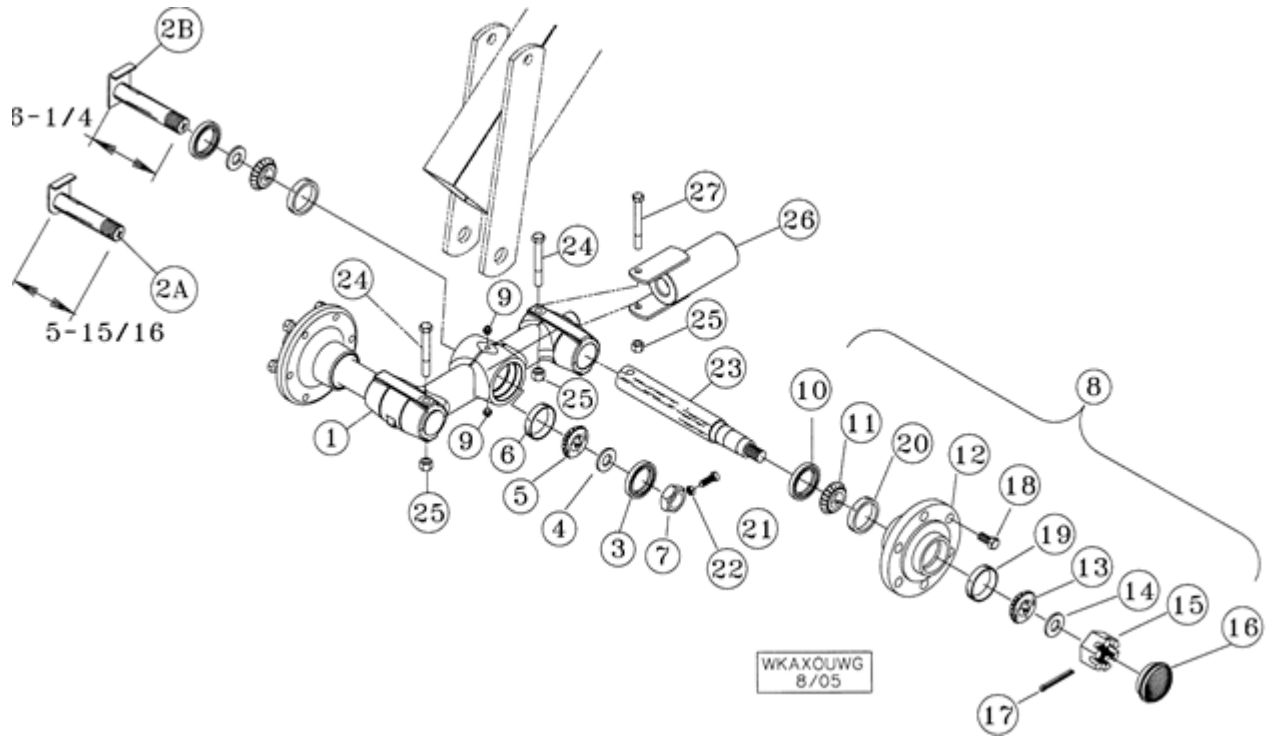









































200 : TIGER-MATE CASE IH FIELD CULTIVATOR

44.100.07 - DOUBLE FOLD WALKING AXLE ASSEMBLY (WINGS ONLY) 38-1/2 THROUG...



200 : TIGER-MATE CASE IH FIELD CULTIVATOR

44.100.07 - DOUBLE FOLD WALKING AXLE ASSEMBLY (WINGS ONLY) 38-1/2 THROUG...

Ссылка	Кол-во	Номер по каталогу	Описание	ОН	Индикаторы
1	1	87459650	AXLE Walking Tandem With Cups		
2A	1	06400290	PIN, SPECIAL Axle, 5-15/16, 10 And 12 Mainframe		
2B	1	04661850	PIN Axle, 6-1/4, 14 Mainframe		
3	2	21932090	SEAL, OIL 2.094 Bore, CR#20952		
4	2	06201425	SPACER		
5	2	160558C91	BEARING, CONE 1.50 Bore, Timken #LM29749		 
6	2	478793R1	BEARING SET 2.56 OD, Timken #LM29710		 
7	1	14032409	NUT, SPECIAL 1-1/2, Jam		
8	2	87327566	SPINDLE 710, 6-Bolt		
9	2	219-86	NIPPLE, LUBE 1/8" x .62" lg, Drive, Self Tap		  
10	1	614410R91	SEAL 1.625 ID x 2.63 OD, CR#163221		
11	1	618023R91	BEARING, CONE 1.375 Bore, Timken LM48548		  
12	1	28270900	HUB ASSY. W709, With Cups		
13	1	651818R91	BEARING, CONE 1.25 Bore, Timken #LM67048		  
14	2	87716935	WASHER		
15	1	425-1314	NUT, SLOTTED 7/8"-14, G5,		 
16	1	28477700	HUB CAP		
17	1	432-1024	PIN, SPLIT (COTTER) 5/32" x 1 1/2",		 
18	6	549962R1	BOLT 1/2 NF x 1-15/32, Lug		  
19	1	651817R1	BEARING, CUP 2.33 OD, Timken #LM67010		  
20	1	618024R1	BEARING, CUP 2.56 OD, Timken #LM48510		  
21	1	16806045	SCREW 3/8 x 1, Square Head Set		
22	1	425-146	NUT Jam, 3/8"-16, G5,		   
23	2	87327569	STUB AXLE/STRG.SPINDLE 710 - 1-7/8		
24	2	413-860	BOLT Hex, 1/2"-13 x 3 3/4", G5,		  
25	2	86992215	NUT, LOCK 1/2"-13, GC, Stover		  
26	1	87342062	WEIGHT, COUNTER Wheel Weight, 38-1/2 Through 46-1/2 Models Only		
27	1	413-872	BOLT Hex, 1/2"-13 x 4 1/2", G5, Wheel Weight		

200 : TIGER-MATE CASE IH FIELD CULTIVATOR

44.100.08 - DOUBLE FOLD WALKING AXLE ASSEMBLY (WINGS ONLY) 48-1/2 THR...

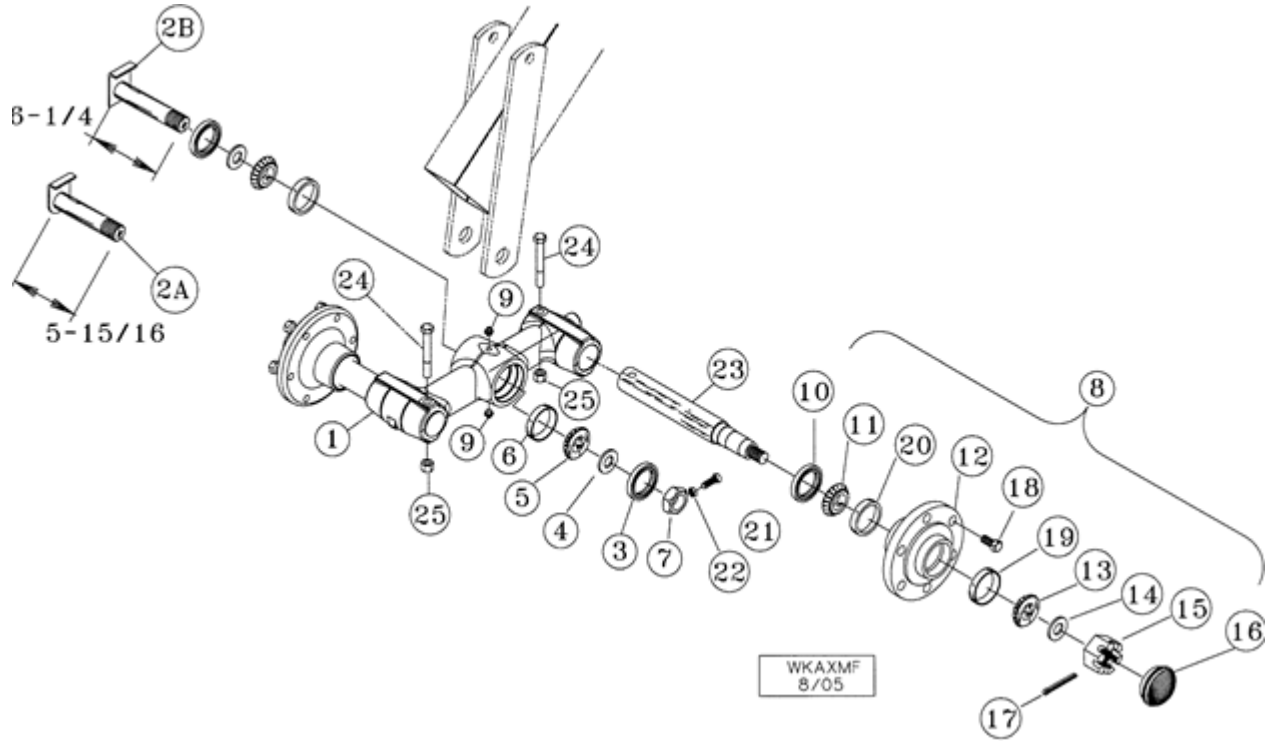

200 : TIGER-MATE CASE IH FIELD CULTIVATOR

44.100.08 - DOUBLE FOLD WALKING AXLE ASSEMBLY (WINGS ONLY) 48-1/2 THR...

Ссылка	Кол-во	Номер по каталогу	Описание	ОН	Индикаторы
1	1	87459650	AXLE Walking Tandem With Cups		
2A	1	06400290	PIN, SPECIAL Axle, 5-5/16		
2B	1	04661850	PIN Axle, 6-1/4		
3	2	21932090	SEAL, OIL 2.094 Bore, CR#20952		
4	2	06201425	SPACER		
5	2	160558C91	BEARING, CONE 1.50 Bore, Timken # LM29749		
6	2	478793R1	BEARING SET 2.56 OD, Timken # LM29710		
7	1	14032409	NUT, SPECIAL 1-1/2, Jam		
8	2	87327566	SPINDLE 710, 6-Bolt		
9	1	219-86	NIPPLE, LUBE 1/8" x .62" lg, Drive, Self Tap		
10	1	87613192	WASHER 1.625 ID x 2.63 OD, CR#163221		
11	1	618023R91	BEARING, CONE 1.375 Bore, Timken #LM48548		
12	1	28270900	HUB ASSY. W709		
13	1	651818R91	BEARING, CONE 1.25 Bore, Timken #LM67048		
14		87716935	WASHER		
15	1	425-1314	NUT, SLOTTED 7/8"-14, G5,		
16	1	28477700	HUB CAP		
17	1	432-1024	PIN, SPLIT (COTTER) 5/32" x 1 1/2",		
18	6	549962R1	BOLT 1/2, NF x 1-15/32, Lug		
19	1	651817R1	BEARING, CUP 2.33 OD, Timken #LM67010		
20	1	615024R1	WASHER 2.56 OD, Timken #LM48510		
21	1	16806045	SCREW 3/8 x 1, Square Head Set		
22	1	425-146	NUT Jam, 3/8"-16, G5,		
23	2	87327569	STUB AXLE/STRG.SPINDLE 710, 1-7/8		
24	2	413-860	BOLT Hex, 1/2"-13 x 3 3/4", G5,		
25	2	86992215	NUT, LOCK 1/2"-13, GC, Stover		





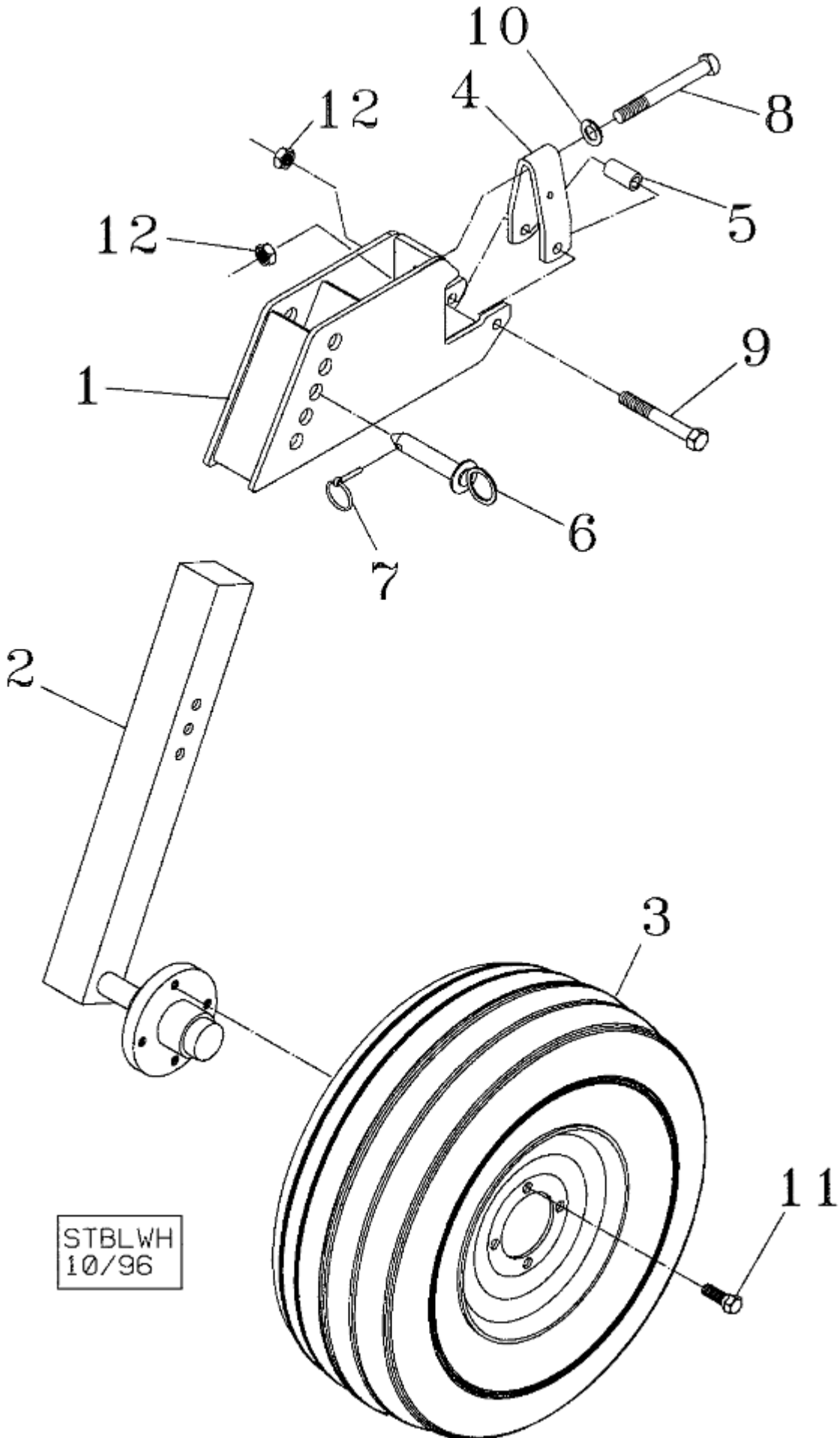











200 : TIGER-MATE CASE IH FIELD CULTIVATOR

44.100.09 - WING RIGID STABILIZER WHEEL



200 : TIGER-MATE CASE IH FIELD CULTIVATOR

44.100.09 - WING RIGID STABILIZER WHEEL

Ссылка	Кол-во	Номер по каталогу	Описание	ОН	Индикаторы
1	1	06400080	CHANNEL Gauge Wheel		
2	1	06400090	CHANNEL Extension With 633 Hub		
3	1	10060250	WHEEL, LAND 5.90 - 15, With Tube, Silver, Rim Only 10159250		
3	1	10060260	WHEEL, LAND 5.90 - 15, Tubeless, Silver, Rim Only 10159250		
4	1	06405150	CLAMP		
5	1	06405140	PLUG Bushing		
6	1	14816348	PIN		
7	1	A30338	PIN 1/4 x 1.75, Klik		
8	1	413-10104	BOLT Hex, 5/8"-11 x 6 1/2", G5,		
9	1	88729	BOLT Hex, 5/8"-11 x 5", G5,	 	
10	1	495-81028	WASHER 21/32" x 1 1/2" x .240",	 	
11	4	549962R1	BOLT 1/2 x 1, Wheel		
12	2	85700693	NUT, LOCK 5/8"-11, GC,	 	





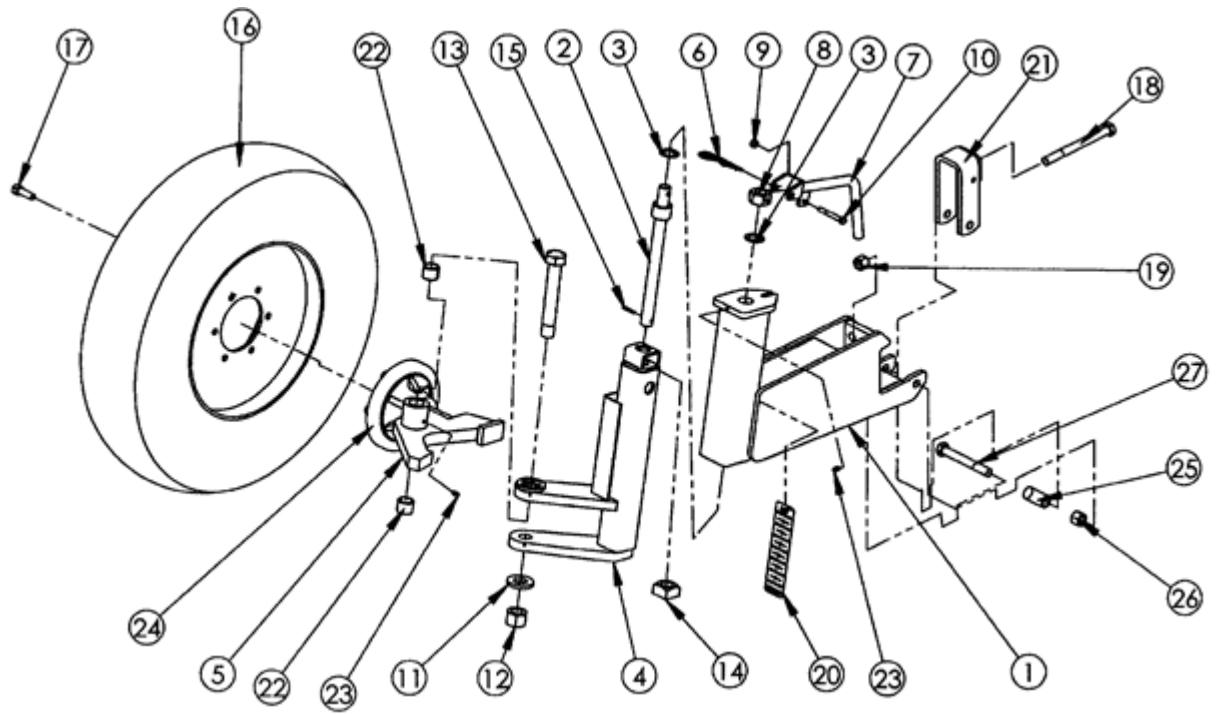



















200 : TIGER-MATE CASE IH FIELD CULTIVATOR

44.100.10 - PIVOT STABILIZING WHEEL 2007 AND PRIOR UNITS



200 : TIGER-MATE CASE IH FIELD CULTIVATOR

44.100.10 - PIVOT STABILIZING WHEEL 2007 AND PRIOR UNITS

Ссылка	Кол-во	Номер по каталогу	Описание	OH	Индикаторы
1	1	87455305	MOUNTING PARTS Support Arm		
2	1	87448201	ADJUSTER Stud, Gauge Wheel.		
3	2	17616021	BUSHING 1, Machine, 14 ga, ZP		
4	1	87446662	SLIDE Inner, Gauge Wheel		
5	1	87446663	PIVOT ASSY. Gauge Wheel, Lh		
5	1	87448193	PIVOT ASSY. Gauge Wheel, Rh		
6	1	1978738C1	PIN, SPLIT (COTTER) Hair		 
7	1	87446661	HANDLE Gauge Wheel		
8	1	87448204	NUT, SPECIAL Adjuster Stud, 1, NC		
9	1	86992212	NUT, LOCK 0.3125, ZP, Stover, gd c		
10	1	413-540	BOLT Hex, 5/16"-18 x 2 1/2", G5,		
11	1	17916100	WASHER, SPECIAL 1 x 1/4		 
12	1	87304132	NUT, LOCK 1"-8, GC, 1, ZP, gd b		
13	1	5971	BOLT Hex, 1"-8 x 7", G8, Full Thd,		
14	1	87448791	NUT Square, 1, NC		
15	1	438-31220	PIN 3/16" x 1 1/4", Coiled,		
16	1	87451736	WHEEL ASSY. 7.6 x 15, 6-PR, Tube, Silver		 
17	6	549962R1	BOLT Wheel, 1/2 NF, XS 1 - 15/32		 
18	2	280293	BOLT Hex, 5/8"-11 x 7", G5,		 
19	2	85700693	NUT, LOCK 5/8"-11, GC,		 
20	1	87450575	DECAL Depth Indicator		
21	1	06405139	CLAMP 2 Bolt Clamp		
22	2	87401008	BUSHING Connex, 1-1/4 x 1 x 1		
23	2	219-87	NIPPLE, LUBE 1/4"-28 x .56" lg, Self-Tap,		  
24	1	87448205	HUB ASSY. QDS, 710 Assembly		
25	1	06405149	BUSHING, LARGE Spacer		
26	1	85700693	NUT, LOCK 5/8"-11, GC,		 
27	1	88729	BOLT Hex, 5/8"-11 x 5", G5,		 

200 : TIGER-MATE CASE IH FIELD CULTIVATOR

44.100.11 - PIVOT STABILIZING WHEEL 2008 AND AFTER UNITS

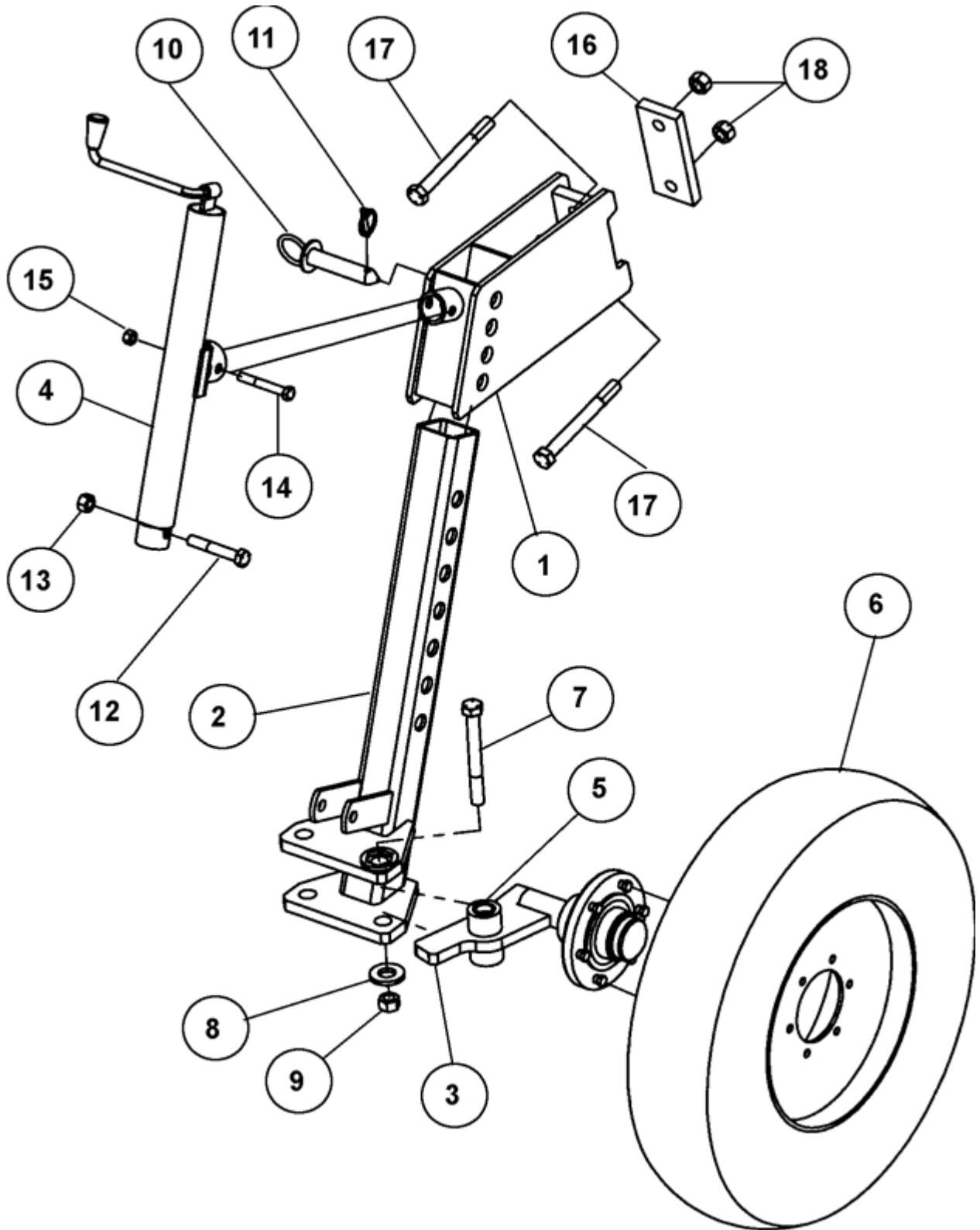

200 : TIGER-MATE CASE IH FIELD CULTIVATOR

44.100.11 - PIVOT STABILIZING WHEEL 2008 AND AFTER UNITS

Ссылка	Кол-во	Номер по каталогу	Описание	ОН	Индикаторы
1	1	87604180	WHEEL, IDLER Mount, Gauge Wheel		
2	1	87604184	BRACKET Bracket, Gauge Wheel		
3	1	87604185	PIVOT Weld		
4	1	87604193	JACK Weld, For 14 Rear Truss		
4	1	84163961	JACK Screw, Used On 2009 And After Units		
5	2	87584013	BEARING Poly Bushing		
6	1	87451736	WHEEL ASSY. 7.6 x 15, Tube, Silver		
7	1	5971	BOLT Hex, 1"-8 x 7", G8, Full Thd,		
8	2	495-81074	WASHER 1 1/32" x 1 3/4" x .120",		
9	1	86992219	NUT, LOCK 1, Stover		
10	1	14816348	PIN		
11	1	A30338	PIN Klick		
12	1	413-1060	BOLT Hex, 5/8"-11 x 3 3/4", G5,		
13	1	85700693	NUT, LOCK 5/8"-11, GC,		
14	1	413-852	BOLT Hex, 1/2"-13 x 3 1/4", G5,		
15	1	86992215	NUT, LOCK 1/2"-13, GC, Stover		
16	1	87698627	BRACKET Flat Mount		
17	6	413-1288	BOLT Hex, 3/4"-10 x 5 1/2", G5,		
18	6	280375	NUT, LOCK 3/4"-10, GC,		

200 : TIGER-MATE CASE IH FIELD CULTIVATOR

44.100.12 - 50-8 HUB AND SPINDLE ASSEMBLY

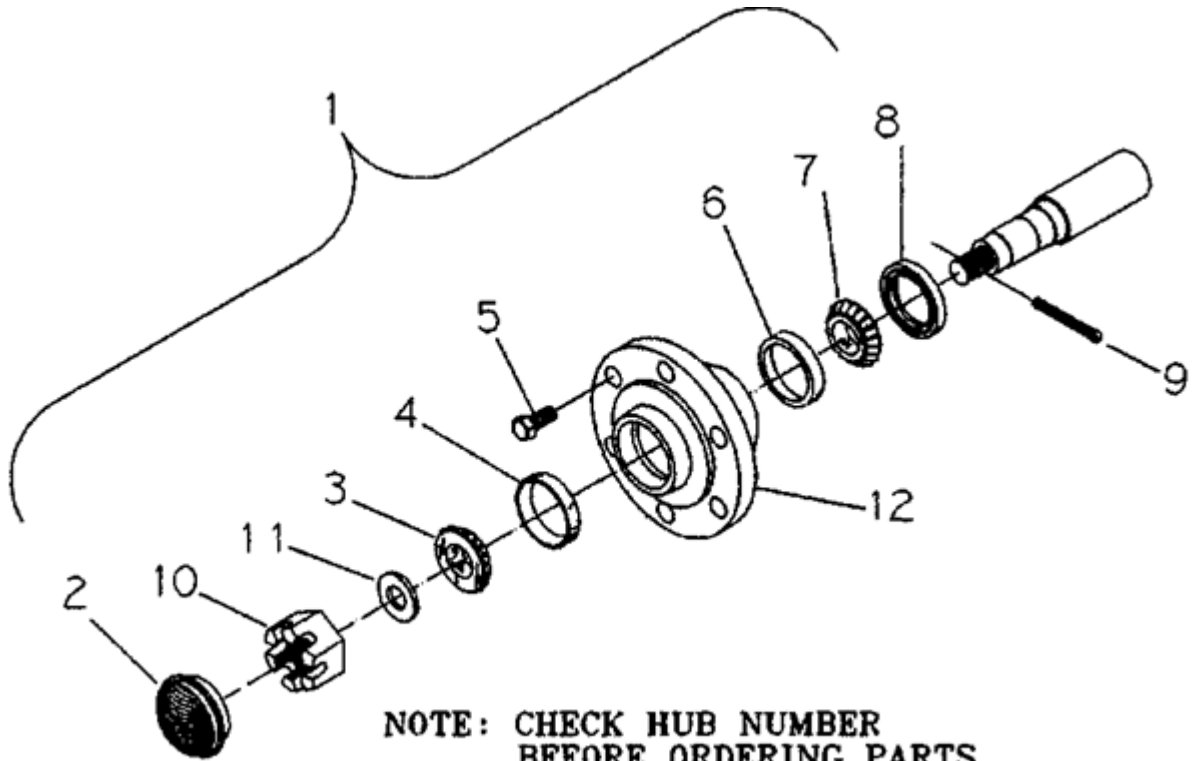

**NOTE: CHECK HUB NUMBER
BEFORE ORDERING PARTS.**

3S07E012

200 : TIGER-MATE CASE IH FIELD CULTIVATOR

44.100.12 - 50-8 HUB AND SPINDLE ASSEMBLY

Ссылка	Кол-во	Номер по каталогу	Описание	ОН	Индикаторы
1	1	84235586	HUB		
2	1	560950R1	HUB CAP		 
3	1	663557R91	BEARING, CONE		 
4					
5	1	557309R1	BOLT		
6	1	21932502	SEAL, OIL		
7	1	376463C1	BEARING, ROLLER, TAPERED		
8	1	21872005	BEARING, CONE		
9	1	432-1232	PIN, SPLIT (COTTER) 3/16" x 2",		 
10	1	427652	NUT, SLOTTED 1"-14, G5,		
11	1	17916100	WASHER, SPECIAL		 
12	1	28250800	HUB ASSY.		
13	1	84235584	SPINDLE		





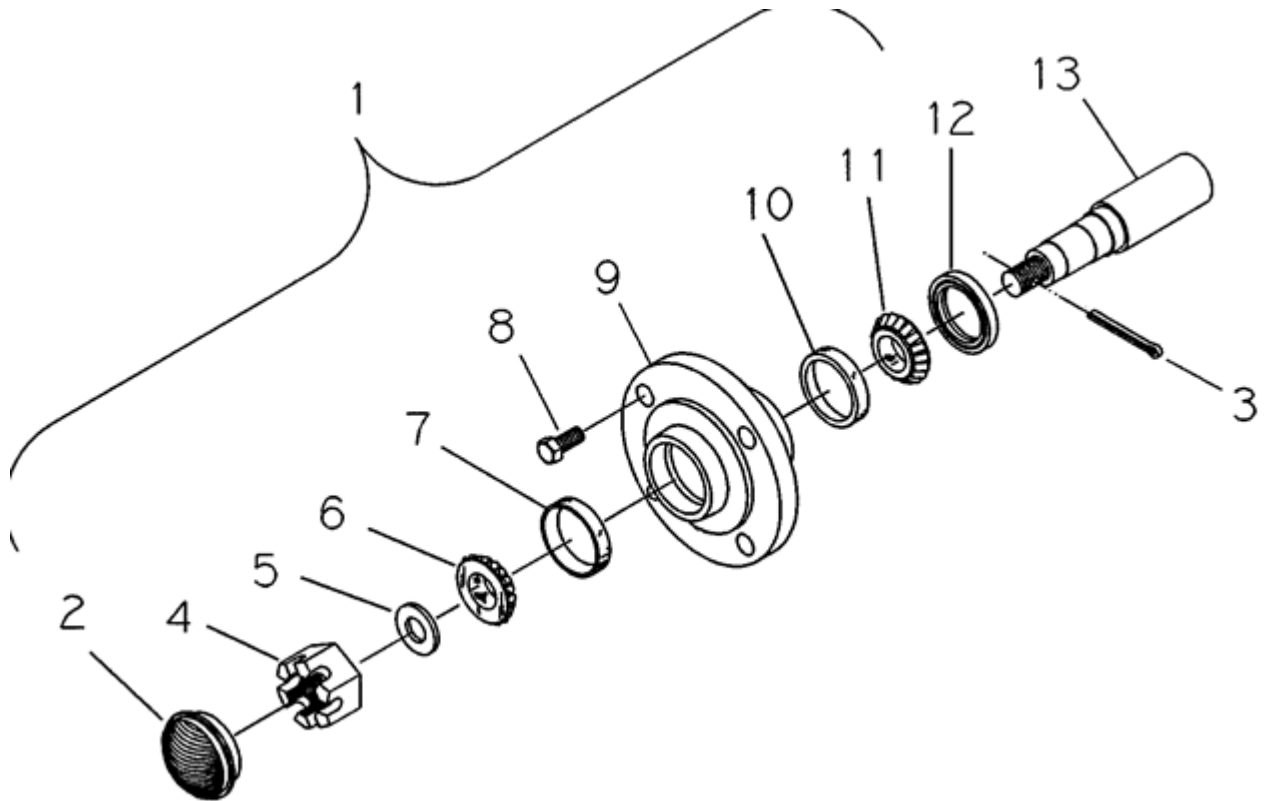























200 : TIGER-MATE CASE IH FIELD CULTIVATOR

44.100.13 - 633 HUB AND SPINDLE ASSEMBLY



200 : TIGER-MATE CASE IH FIELD CULTIVATOR

44.100.13 - 633 HUB AND SPINDLE ASSEMBLY

Ссылка	Кол-во	Номер по каталогу	Описание	ОН	Индикаторы
1	1	28063362	HUB ASSY. Inc. 1-13		
1	1	28163311	HUB ASSY. 633, 4- Bolt, Inc. 2-12		
2	1	28463300	HUB CAP		
3	1	432-1024	PIN, SPLIT (COTTER) 5/32" x 1 1/2",		 
4	1	425-1312	NUT, SLOTTED 3/4"-16, G5,		 
5	1	17413001	WASHER		
6	1	651815R91	BEARING, CONE 75 Bore, Timken # LM11949		  
7	1	651814R1	BEARING, CUP 1.78 OD, Timken #LM11910		  
8	4	549962R1	BOLT Wheel, 1/2 x 1-1/2		  
8	4	414-820	BOLT Hex, 1/2"-20 x 1 1/4", G5, Full Thd, Flat Head		 
9	1	28263340	HUB 633		
10	1	651817R1	BEARING, CUP 2.33 OD, Timken #LM67010		  
11	1	651818R91	BEARING, CONE 1.25 Bore, Timken #LM67048		  
12	1	126621C1	SEAL ASSY. 1.50 ID x 2.33 OD, CR#14975		
13	1	28363322	SPINDLE		





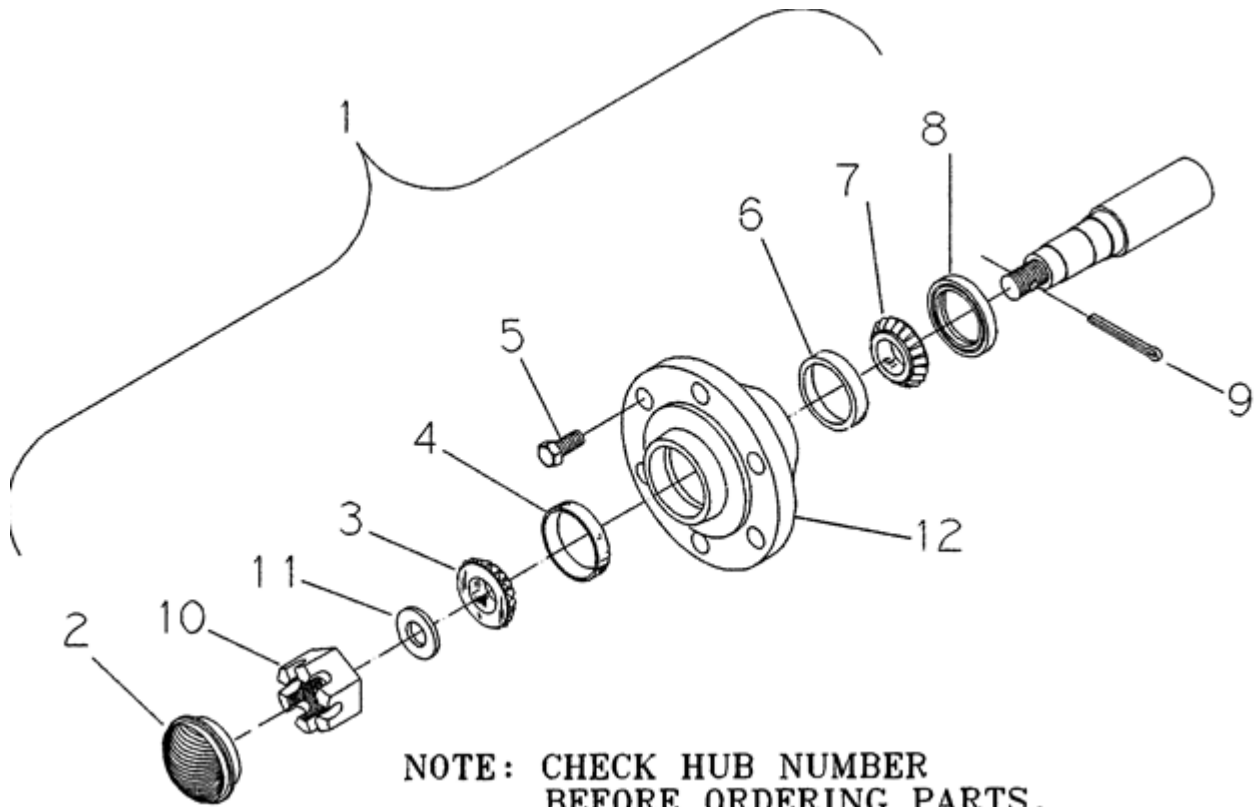











200 : TIGER-MATE CASE IH FIELD CULTIVATOR

44.100.14 - 710 HUB AND SPINDLE ASSEMBLY



200 : TIGER-MATE CASE IH FIELD CULTIVATOR

44.100.14 - 710 HUB AND SPINDLE ASSEMBLY

Ссылка	Кол-во	Номер по каталогу	Описание	ОН	Индикаторы
1	1	87327566 28171000	SPINDLE Inc 1-13 HUB ASSY. Q-710, 6-Bolt, Inc. 2-12		
2	1	28477700	HUB CAP		
3	1	651818R91	BEARING, CONE 1.25, Timken LM67048		 
4	1	651817R1	BEARING, CUP 2.33 OD, Timken LM67010		 
5	6	549962R1	BOLT 1/2, NF, Lug		 
6	1	618024R1	BEARING, CUP 2.56 OD, Timken LM48510		 
7	1	618023R91	BEARING, CONE 1.38, Timken LM48548		  
8	1	614410R91	SEAL 1.63 ID x 2.63 OD, CR16322		
9	1	432-1024	PIN, SPLIT (COTTER) 5/32" x 1 1/2",		
10	1	425-1314	NUT, SLOTTED 7/8"-14, G5,		 
11	2	87716935	WASHER		
12	1	28270900	HUB ASSY.		
13	1	87327569	STUB AXLE/STRG.SPINDLE 710, 1.875 OD		





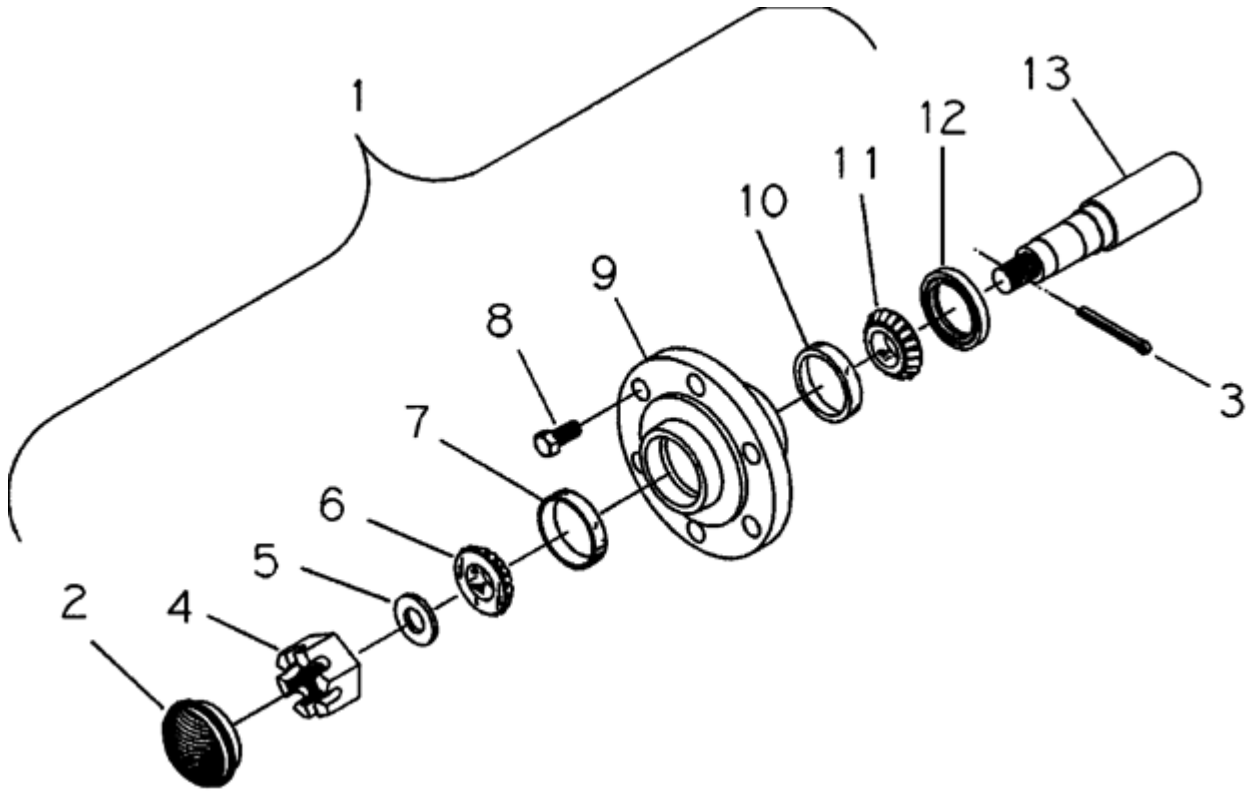













200 : TIGER-MATE CASE IH FIELD CULTIVATOR

44.100.15 - 710 HUB AND SPINDLE ASSEMBLY, WINGS ONLY



200 : TIGER-MATE CASE IH FIELD CULTIVATOR

44.100.15 - 710 HUB AND SPINDLE ASSEMBLY, WINGS ONLY

Ссылка	Кол-во	Номер по каталогу	Описание	ОН	Индикаторы
1	1	87327566 28171000	SPINDLE Inc. 1 - 13 HUB ASSY. Q-710, 6 Bolt, Inc. 2-12		
2	1	28477700	HUB CAP		
3	1	432-1024	PIN, SPLIT (COTTER) 5/32" x 1 1/2",		 
4	1	425-1314	NUT, SLOTTED 7/8"-14, G5,		 
5	2	87716935	WASHER		
6	1	651818R91	BEARING, CONE 1.25, Timken LM67048		  
7	1	651817R91	BEARING SET 2.33 OD, Timken LM67010		
8	6	549962R1	BOLT 1/2, NF, Lug		  
9	1	28270900	HUB ASSY.		
10	1	615024R1	WASHER 2.56 OD, Timken LM48510		
11	1	618023R91	BEARING, CONE 1.38, Timken LM48548		  
12	1	614410R91	SEAL 1.63 ID x 2.63 OD, CR16322		
13	1	87327569	STUB AXLE/STRG.SPINDLE 710, 1.875 OD		





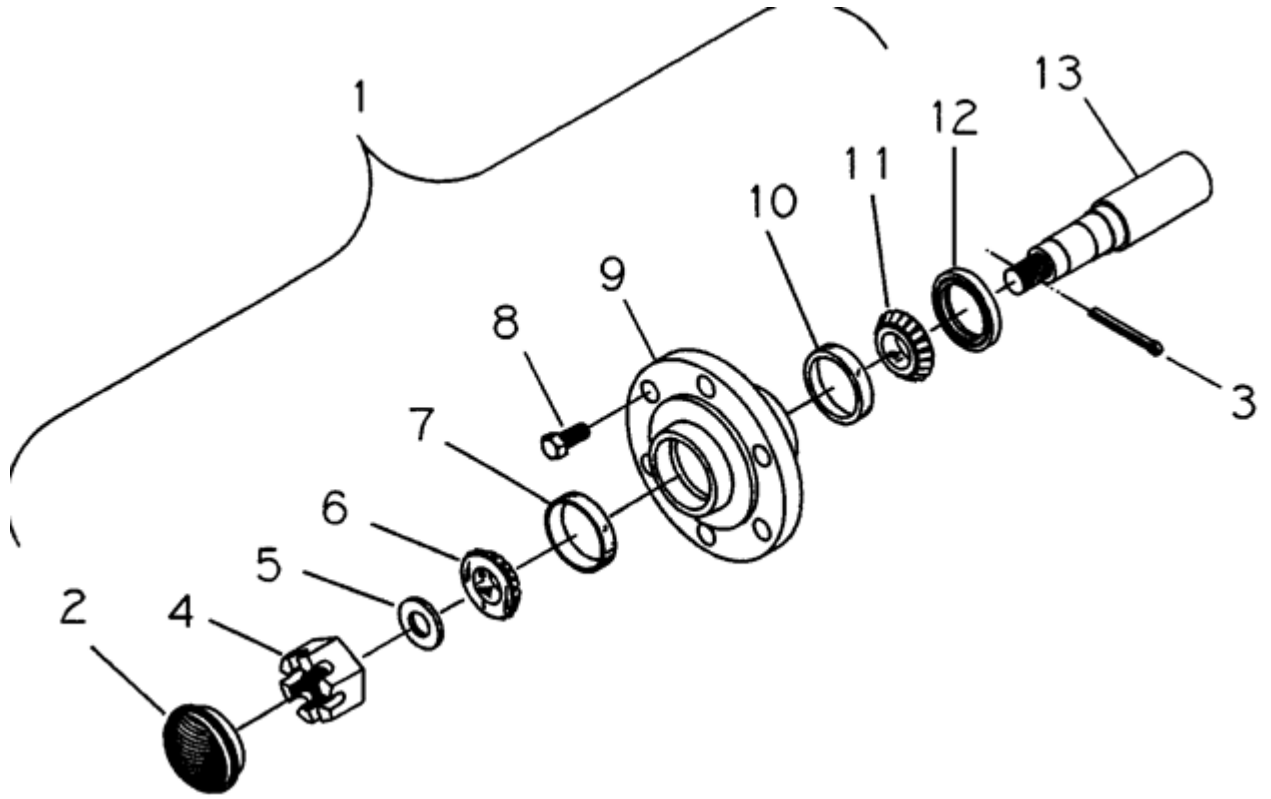















200 : TIGER-MATE CASE IH FIELD CULTIVATOR

44.100.16 - 783 HUB



200 : TIGER-MATE CASE IH FIELD CULTIVATOR

44.100.16 - 783 HUB

Ссылка	Кол-во	Номер по каталогу	Описание	ОН	Индикаторы
1	1	28178300	HUB ASSY. 783, 6-Bolt		
2	1	28477700	HUB CAP		
3	1	432-1024	PIN, SPLIT (COTTER) 5/32" x 1 1/2",		
4	1	425-1314	NUT, SLOTTED 7/8"-14, G5,		 
5	1	495-61094	WASHER 7/8" x 2 1/4" x .16",		 
6	1	651818R91	BEARING, CONE 1.25 Bore, Timken #LM67048		 
7	1	651817R1	BEARING, CUP 2.33 OD, Timken #LM67010		 
8	6	549962R1	BOLT 1/2 NF x 1-1/5/32, Lug		 
9	1	28278300	HUB		
10	1	663558R1	BEARING, CUP 2.89 OD, Timken #LM501310		 
11	1	663557R91	BEARING, CONE 1.624 Bore, Timken #LM501349		 
12	1	145769C91	SEAL 1.875 ID x 3.005 OD, CR#18823		 
13	1	28378351	SPINDLE 1-7/8 Diameter		
14	1	28078350	HUB ASSY. Hub & Spindle, Not Shown		

200 : TIGER-MATE CASE IH FIELD CULTIVATOR

44.100.17 - 10 AND 12 SINGLE FOLD MAIN FRAME WALKING BEAM SERVICE PART KIT

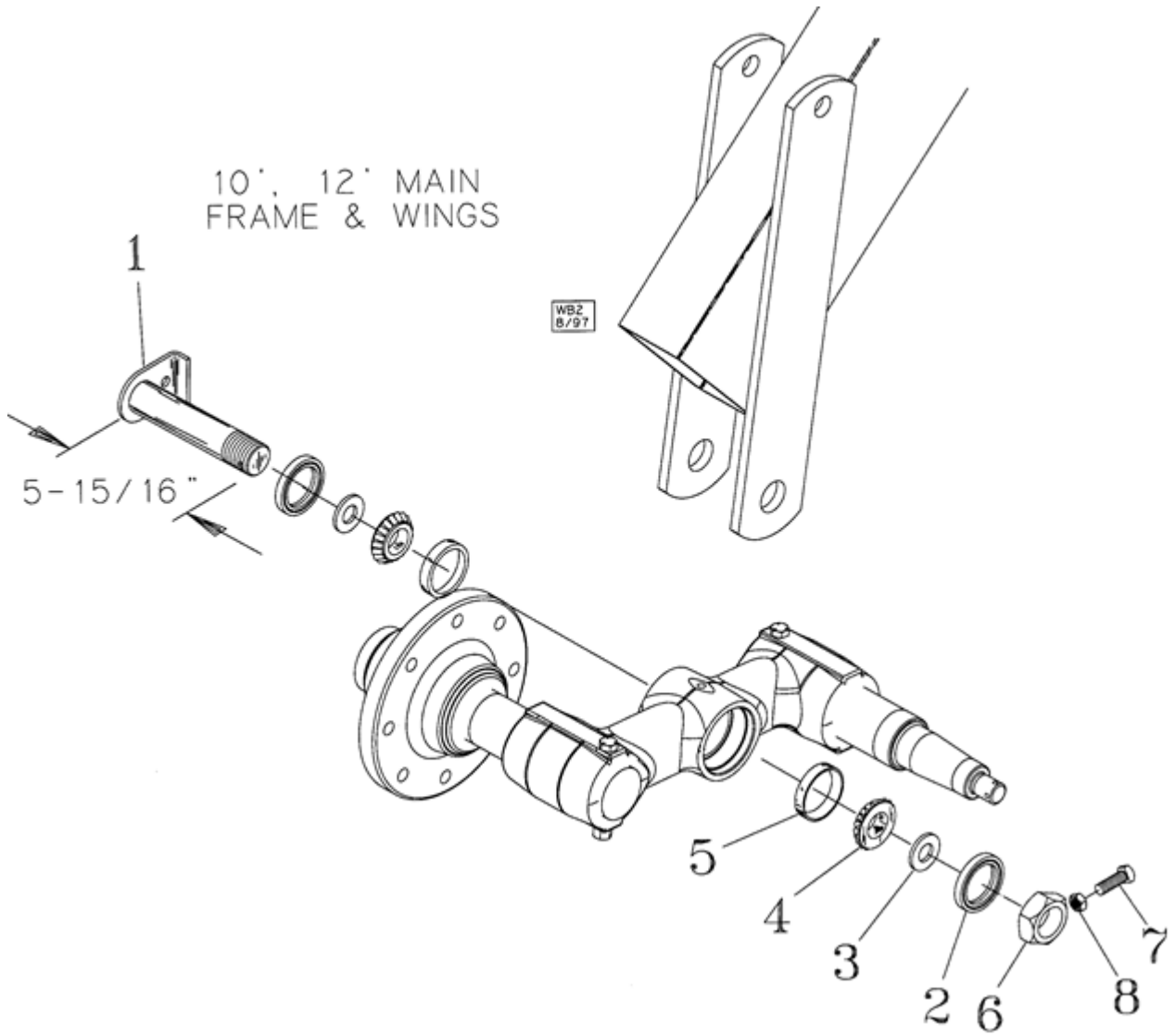

200 : TIGER-MATE CASE IH FIELD CULTIVATOR

44.100.17 - 10 AND 12 SINGLE FOLD MAIN FRAME WALKING BEAM SERVICE PART KIT

Ссылка	Кол-во	Номер по каталогу	Описание	ОН	Индикаторы
1	1	06400290	PIN, SPECIAL Axle		
2	2	21932090	SEAL, OIL 2.094 Bore, CR20952		
3	2	06201420	SPACER Seal		
4	2	160558C91	BEARING, CONE 1.50 Bore, Timken #LM29749		 
5	2	478793R1	BEARING SET 2.56 OD, Timken #LM29710		 
6	1	14032409	NUT, SPECIAL 1-1/2, NC, Hex, Jam		
7	1	16806045	SCREW 3/8 x 1, NC, Square Head Set		
8	1	425-146	NUT Jam, 3/8"-16, G5,		  
9	1	06401040	BEARING SET Service Kit, Inc. 1 - 8		 

200 : TIGER-MATE CASE IH FIELD CULTIVATOR

44.100.18 - SINGLE FOLD 14 MAIN FRAME ONLY WALKING BEAM SERVICE PART KIT

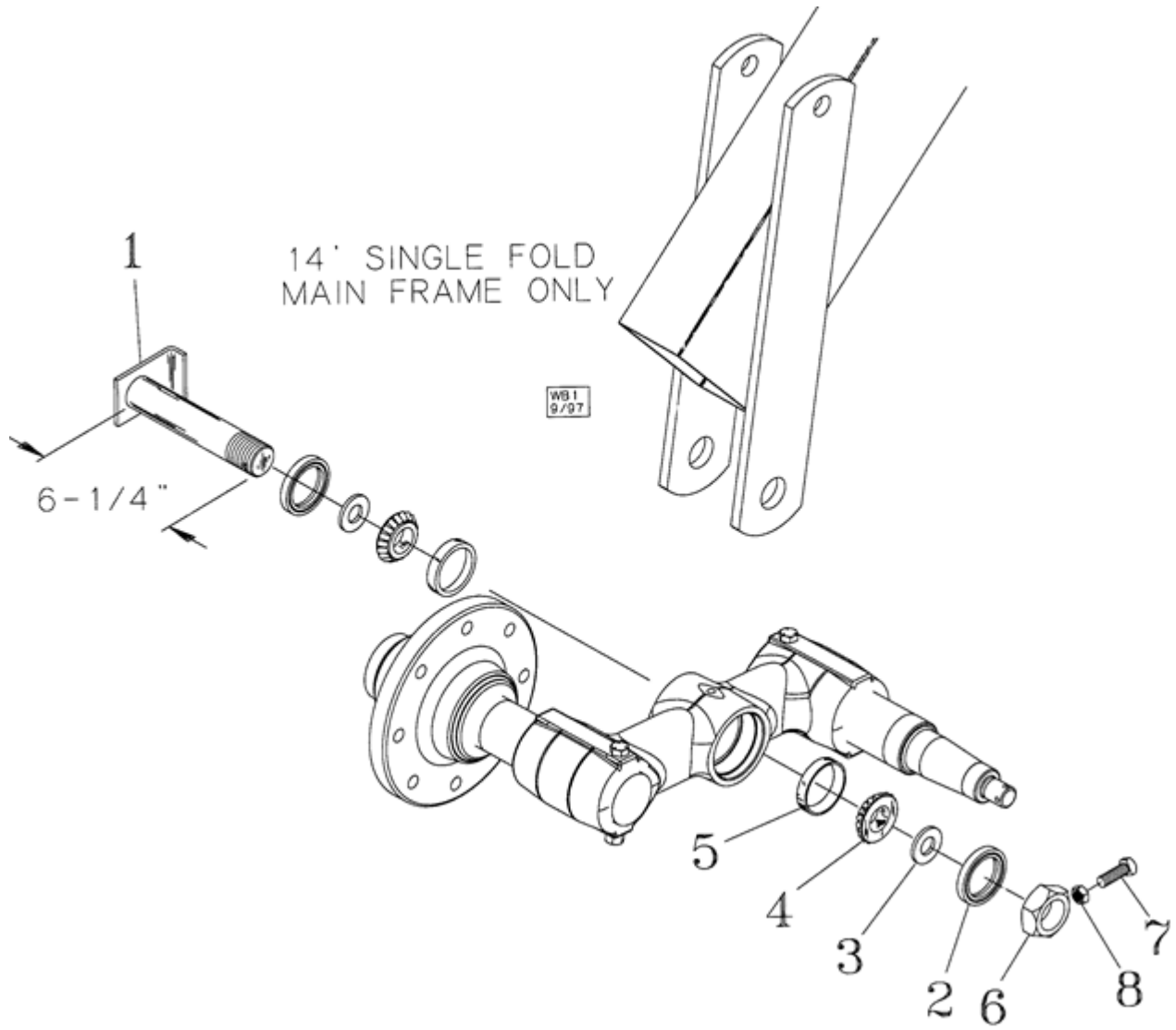

200 : TIGER-MATE CASE IH FIELD CULTIVATOR

44.100.18 - SINGLE FOLD 14 MAIN FRAME ONLY WALKING BEAM SERVICE PART KIT

Ссылка	Кол-во	Номер по каталогу	Описание	ОН	Индикаторы
1	1	04661850	PIN Axle		
2	2	21932510	SEAL 2.094 Bore, CR22870		
3	2	06400573	SPACER Seal		
4	2	21871501	BEARING, CONE 1.50 Bore, 2776		
5	2	17498D	BEARING, CUP 2.56 OD, 2920		 
6	1	14032409	NUT, SPECIAL 1-1/2, NC, Hex Jam		
7	1	16806045	SCREW 3/8 x 1, NC, Square Head Set		
8	1	425-146	NUT Jam, 3/8"-16, G5,		   
9	1	06400540	BEARING SET Service Kit, Inc. 1 - 8		

200 : TIGER-MATE CASE IH FIELD CULTIVATOR

44.100.19 - DOUBLE FOLD WALKING BEAM SERVICE KIT (38-1/2 (12 MAINFRAME...

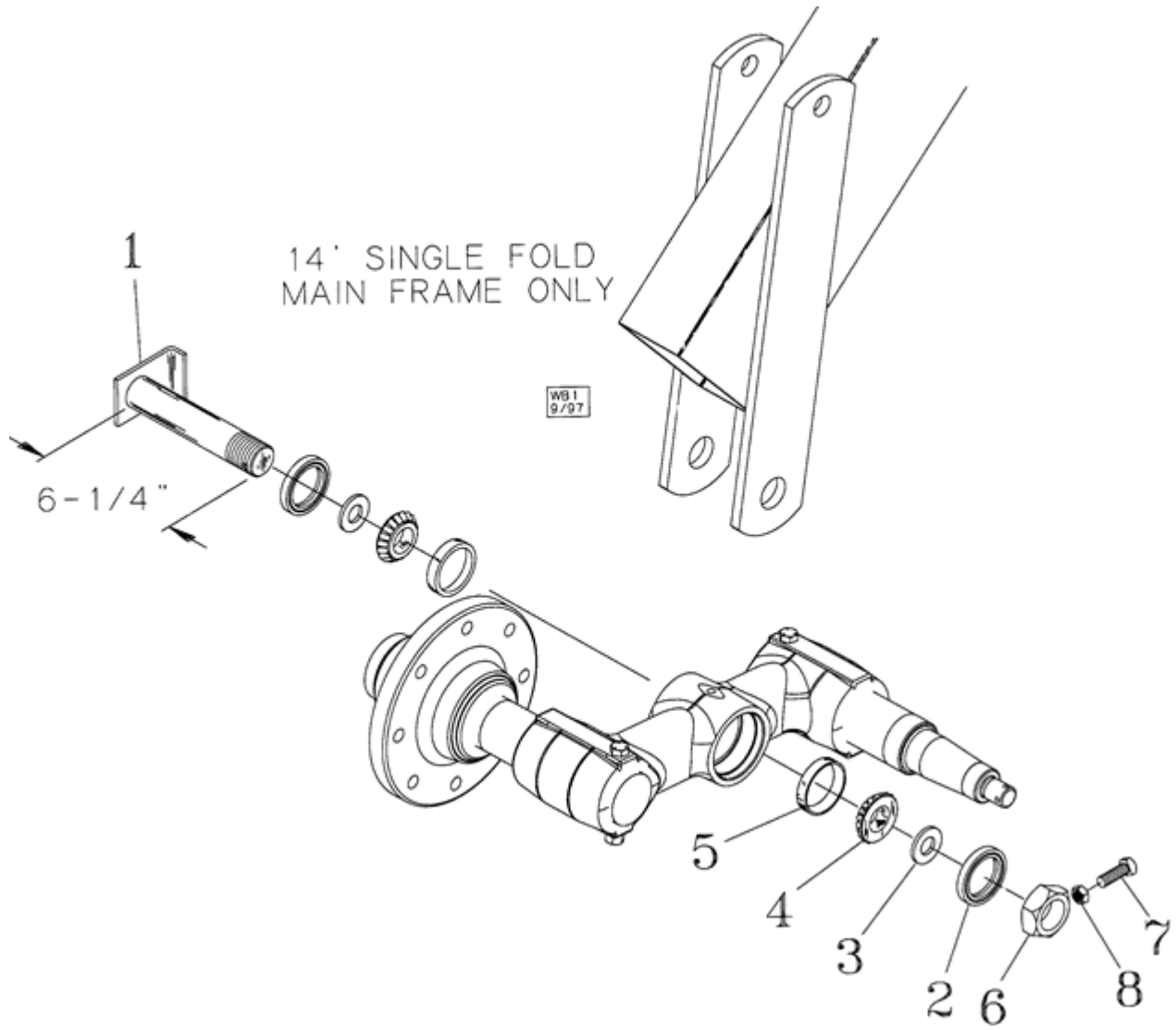

200 : TIGER-MATE CASE IH FIELD CULTIVATOR

44.100.19 - DOUBLE FOLD WALKING BEAM SERVICE KIT (38-1/2 (12 MAINFRAME...

Ссылка	Кол-во	Номер по каталогу	Описание	ОН	Индикаторы
1	1	04661850	PIN Axle		
2	2	21932510	SEAL 2.29 Bore, CR22870		
3	2	06400573	SPACER Seal		
4	2	21871501	BEARING, CONE 1.50 Bore, Timken #2776		
5	2	17498D	BEARING, CUP 3.00 OD, Timken #2720		 
6	1	14032409	NUT, SPECIAL 1-1/2, NC, Hex Jam		
7	1	16806045	SCREW 3/8 x 1, NC, Square Head Set		
8	1	425-146	NUT Jam, 3/8"-16, G5,		  
9	1	06400540	BEARING SET Service Kit, Inc. 1 - 8		 

200 : TIGER-MATE CASE IH FIELD CULTIVATOR



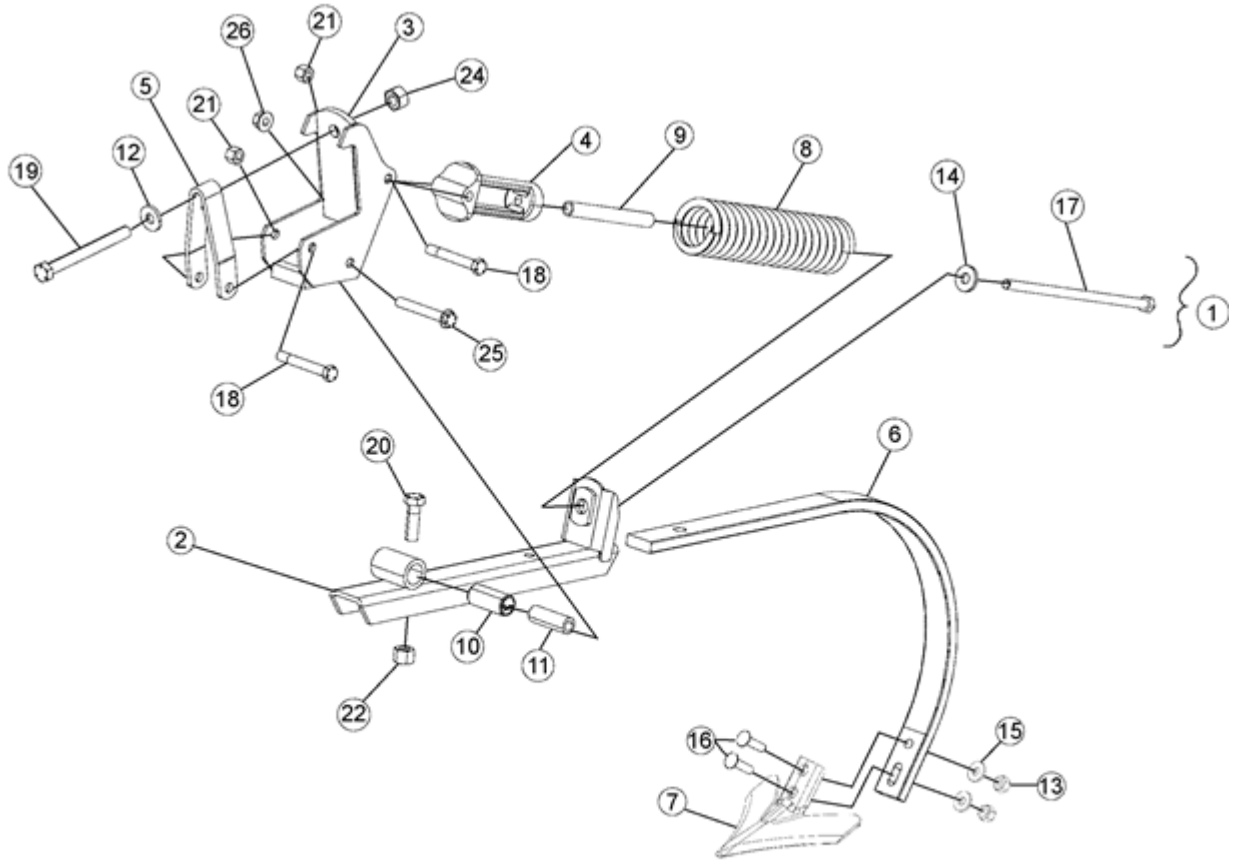











































75.200.01 - TIGERMATE II SHANK ASSEMBLY



3S08A007

200 : TIGER-MATE CASE IH FIELD CULTIVATOR

75.200.01 - TIGERMATE II SHANK ASSEMBLY

Ссылка	Кол-во	Номер по каталогу	Описание	ОН	Индикаторы
1	1	06403000	MOUNTING PARTS Shank, Does Not Include 6 - 7, 15 - 16, And 23		 
1	1	06403260	MOUNTING PARTS Shank, Does Not Include 7, 15 - 16, And 23		 
2	1	06403250	MOUNTING PARTS Shank		
3	1		Replaced By 06403000		
4	1	20090192	SPRING Pivot Casting		
5	1	06210150	BRACKET		
6	1	33017584	SHANK, BUCKET TOOTH		
7	1	372560A1	SWEEP 7.3 Maxxi		
7	1	372561A1	SWEEP 9.3 Maxxi		
7	1	87460413	SWEEP 7.3 Maxxi-Point Plus, Enough To Do One Harrow Section, Adapter = 400309A1, Bolt = 413-724, And Nut = 231-5147		
7	1	380434A1	SWEEP 7.5, Knock On, Adapter = 400309A1, Bolt = 413-724, And Nut = 231-5147		  
7	1	380435A1	SWEEP 9, Knock On, Adapter = 400309A1, Bolt = 413-724, And Nut = 231-5147		  
7	1	87546271	SHANK, POINT RIPPER 2, Chisel, 2006 And Prior Models		
8	1	24143895	SPRING, COMPRESSION		 
9	1	06403415	BUSHING Heat Treated		
10	1	44008755	BUSHING 7/8 ID, Connex		
11	1	06403310	BUSHING Heat Treated		
12	1	17411011	WASHER 5/8, Flat		 
14	1	17409010	WASHER 9/16 ID x 1-3/8 OD		 
15	2	81541	WASHER 7/16",		 
16	2	419-3724	BOLT, PLOW 7/16"-14 x 1 1/2", G5,		
17	1	16908445	BOLT 1/2 x 11, NC, Hex, gr 5		
18	2	16908145	BOLT 1/2 x 3-1/2, NC, Hex, gr 5		
19	1	413-1096	BOLT Hex, 5/8"-11 x 6", G5,		 
20	1	26-1032	BOLT Hex, 5/8"-11 x 2", G8,		 
21	2	86992215	NUT, LOCK 1/2"-13, GC, Stover		  
22	1	85700693	NUT, LOCK 5/8"-11, GC,		 
23	2	425-107	NUT 7/16"-14, G5,		  
24	1	425-1010	NUT 5/8"-11, G5,		   
25	1	16908148	BOLT 1/2, NC, Flange, Heavy Duty, gr 8		
26	1	14120801	NUT, LOCK 1/2, NC, Flanged, gr 8		





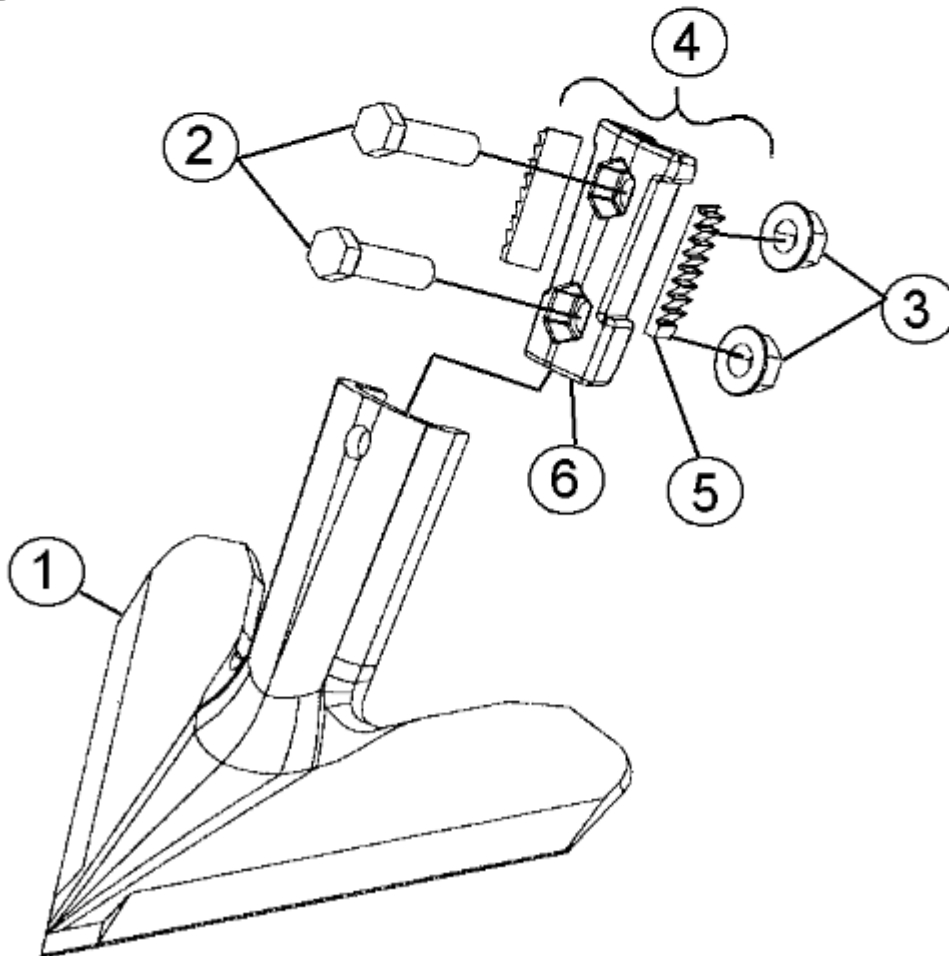
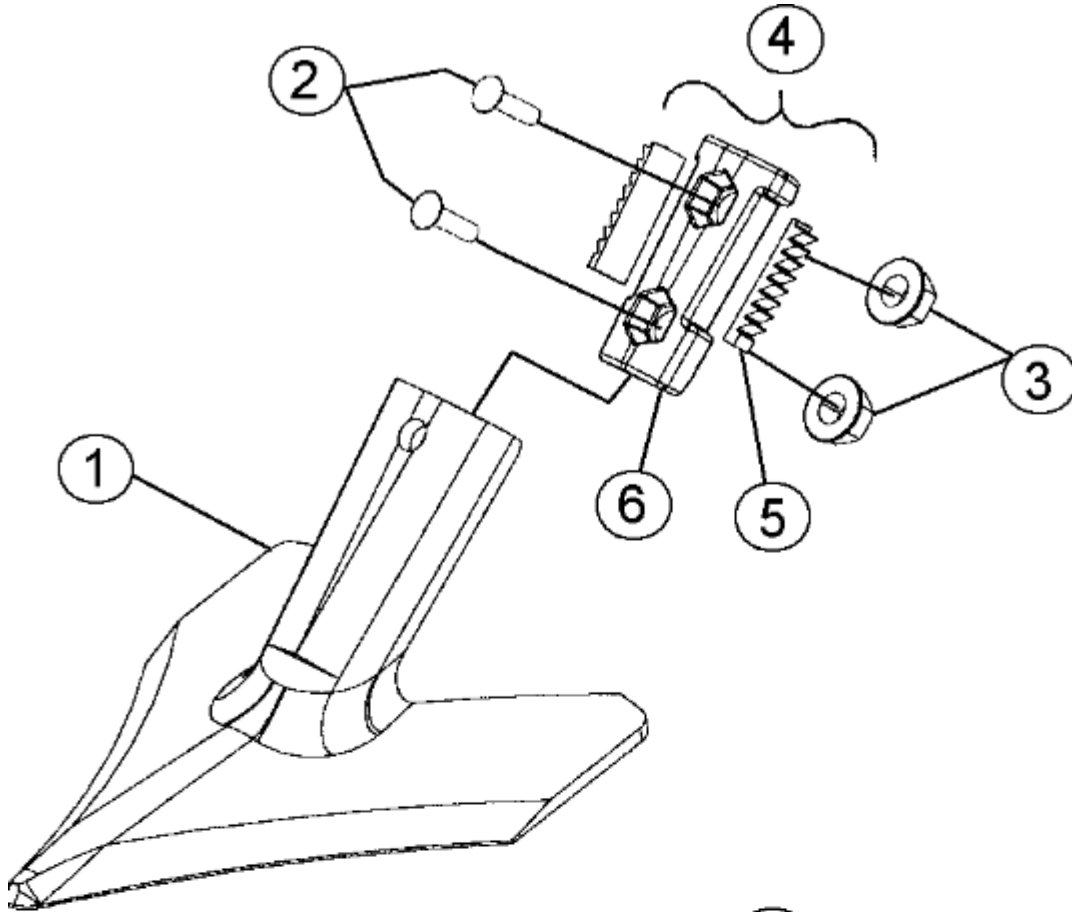











200 : TIGER-MATE CASE IH FIELD CULTIVATOR

75.200.02 - SWEEPS



200 : TIGER-MATE CASE IH FIELD CULTIVATOR

75.200.02 - SWEEPS

Ссылка	Кол-во	Номер по каталогу	Описание	ОН	Индикаторы
1	1	87460413	SWEEP 7.3 Maxxi-Point Plus		
1	1	380434A1	SWEEP 7.5 Knock-On		  
1	1	380435A1	SWEEP 9 Knock-On		  
2	2	413-724	BOLT Hex, 7/16"-14 x 1 1/2", G5,		 
3	2	231-5147	NUT Flg, USR, 7/16"-14,		
4	1	400309A1	ADAPTER Assembly		  
5	2	369918A1	INSERT Sweep Adapter		 
6	1	358213A2	ADAPTER Cultivator Sweep		 

200 : TIGER-MATE CASE IH FIELD CULTIVATOR

75.200.03 - ACS PARTS BREAKDOWN

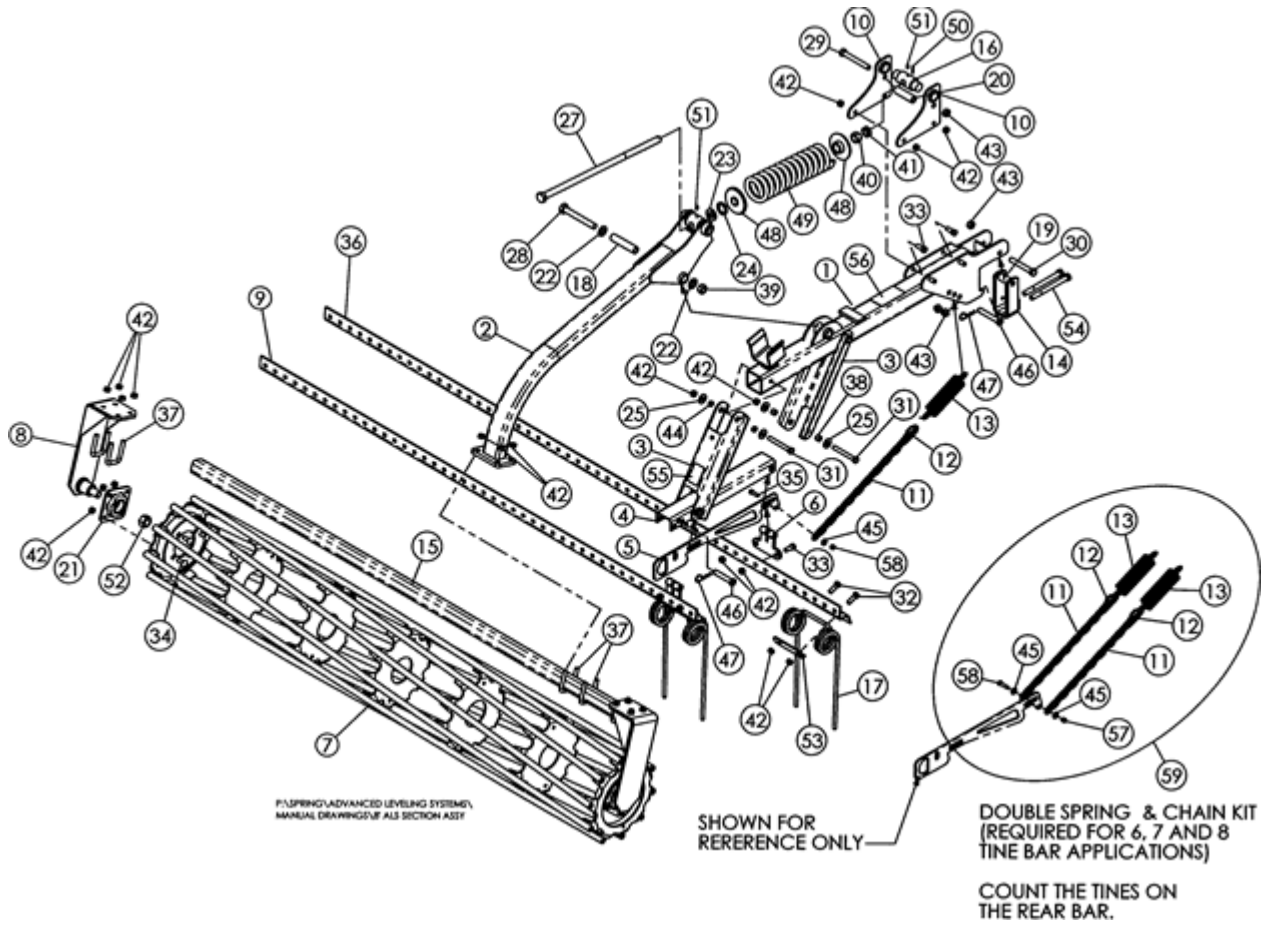























































200 : TIGER-MATE CASE IH FIELD CULTIVATOR

75.200.03 - ACS PARTS BREAKDOWN

Ссылка	Кол-во	Номер по каталогу	Описание	ОН	Индикаторы
1	2	06407100	ARM ASSY. Mounting		
2	2	06407140	FRAME Rear, Mount		
3	4	87457435	ARM Parallel, 14-1/2		
4	2	87457437	CHANNEL Formed		
5	2	06407203	SLIDE Slide		
6	4	06404136	HINGE Tine, Casting		
7	1	06407365	BASKET ASSY 60, Rounds		
7	1	06407375	BASKET ASSY 75, Rounds		
7	1	06407385	BASKET ASSY 90, Rounds		
7	1	06407395	BASKET ASSY 105, Rounds		
7	1	06407315	BASKET ASSY 120, Rounds		
7	1	87441585	BASKET ASSY 60, Flats		
7	1	87441583	BASKET ASSY 75, Flats		
7	1	87438199	BASKET ASSY 90, Flats		
7	1	87438198	BASKET ASSY 105, Flats		
7	1	87438010	BASKET ASSY 120, Flats		
8	2	06407300	PLATE ASSY. Bolt-On Bearing		
9	1	06404175	CHANNEL Tine, 4 On 16 Spacing, 3 On 24 Spacing, 56 Inches		
9	1	06404185	CHANNEL Tine, 5 On 16 Spacing, 72 Inches		
9	1	06404195	CHANNEL Tine, 6 On 16 Spacing, 88 Inches		
9	1	06404205	CHANNEL Tine, 6 On 16 Spacing, 5 On 24 Spacing, 104 Inches		
9	1	06404215	CHANNEL Tine, 8 On 16 Spacing, 120 Inches		
10	4	06407120	SUPPORT ASSY. Spring		
11	2	22004161	CHAIN 1/4 x 19-1/2		
12	2	22105011	LINK ASSY. 5/16 Quick		
13	2	24320010	SPRING Extension, 9		
14	2	06405130	CLAMP 2, Bolt		
15	1	06407351	TUBE Support, 60 Basket		
15	1	06407371	TUBE Support, 75 Basket		
15	1	06407381	TUBE Support, 90 Basket		
15	1	06407391	TUBE Support, 105 Basket		
15	1	06407311	TUBE Support, 120 Basket		
16	2	06407125	TRUNNION Trunion, Mount End		
17	UAR	33443707	TINE 8, Coil		
18	2	06407149	BUSHING Pivot		
19	2	06405140	PLUG Bushing		
20	2	06407126	BUSHING Bushing		
21	2	ST491A	BEARING		
22	4	87381	WASHER 3/4", SAE,		
23	2	87716935	WASHER		
24	2	17620030	BUSHING 1-1/4, Machine, 10 ga		
25	16	80700	WASHER 1/2",		
26	2	17916100	WASHER, SPECIAL 1 Dia. Special		

200 : TIGER-MATE CASE IH FIELD CULTIVATOR

75.200.03 - ACS PARTS BREAKDOWN

Ссылка	Кол-во	Номер по каталогу	Описание	ОН	Индикаторы
27	2	16901495	BOLT, SPECIAL 7/8 x 23-1/2, NC		
28	2	413-1296	BOLT Hex, 3/4"-10 x 6", G5,		 
29	2	88729	BOLT Hex, 5/8"-11 x 5", G5,		  
30	2	413-1068	BOLT Hex, 5/8"-11 x 4 1/4", G5,		
31	8	413-868	BOLT Hex, 1/2"-13 x 4 1/4", G5,		  
32	UAR	413-824	BOLT Hex, 1/2"-13 x 1 1/2", G5, Full Thd,		 
33	16	413-820	BOLT Hex, 1/2"-13 x 1 1/4", G5, Full Thd,		 
34	8	433-820	BOLT, CARRIAGE Short NK, 1/2"-13 x 1 1/4", G5,		
35	6	413-620	BOLT Hex, 3/8"-16 x 1 1/4", G5, Full Thd,		  
36	1	06404175	CHANNEL Tine, 4 On 16 Spacing, 3 On 24 Spacing, 56 Inches		
36	1	06404345	CHANNEL Tine, 4 On 24 Spacing, 80 Inches		
36	1	06404205	CHANNEL Tine, 7 On 16 Spacing, 5 On 24 Spacing, 104 Inches		
36	1	06404365	TINE BAR Tine, 6 On 24 Spacing, 128 Inches		
37	8	16308110	U-BOLT 1/2 x 2 x 3		 
38	8	87457434	BUSHING Pivot, H.T.		
39	2	280375	NUT, LOCK 3/4"-10, GC,		  
40	2	425-1014	NUT 7/8"-9, G5,		 
41	2	425-1414	NUT Jam, 7/8"-9, G5,		 
42	UAR	86992215	NUT, LOCK 1/2"-13, GC, Stover		  
43	UAR	85700693	NUT, LOCK 5/8"-11, GC,		  
44	8	87457432	BUSHING Sleeve H.T.		
45	2	17407015	WASHER 7/16 x 1/8, Thick, gr 8		  
46	4	14810275	CLEVIS 5/8 x 4, Clevis		  
47	2	14720411	PIN, SPLIT (COTTER) 1/8 x 2, Hair		 
48	4	20090120	SPRING BOX Double Spring		
49	2	24162506	SPRING Compression		
50	2	438-31220	PIN 3/16" x 1 1/4", Coiled,		
51	4	219-87	NIPPLE, LUBE 1/4"-28 x .56" lg, Self-Tap,		  
52	2	86992219	NUT, LOCK 1, NC, Stover		
53	UAR	06404220	CHANNEL Tine		
54	4	280293	BOLT Hex, 5/8"-11 x 7", G5,		 
55	2	18534380	DECAL Tine Angle		
56	2	18534381	DECAL Information		
57	2	86992213	NUT, LOCK 3/8, NC, Stover		  
58	2	413-624	BOLT Hex, 3/8"-16 x 1 1/2", G5,		  
59	1	87405850	SPRING Spring And Chain, Inc. 11 - 13, 45, And 57 - 58, To Convert Single Spring Application To Double Spring Application - Required on 6-8 Rear Tine Sections		

200 : TIGER-MATE CASE IH FIELD CULTIVATOR

75.200.04 - COIL TINE HARROW

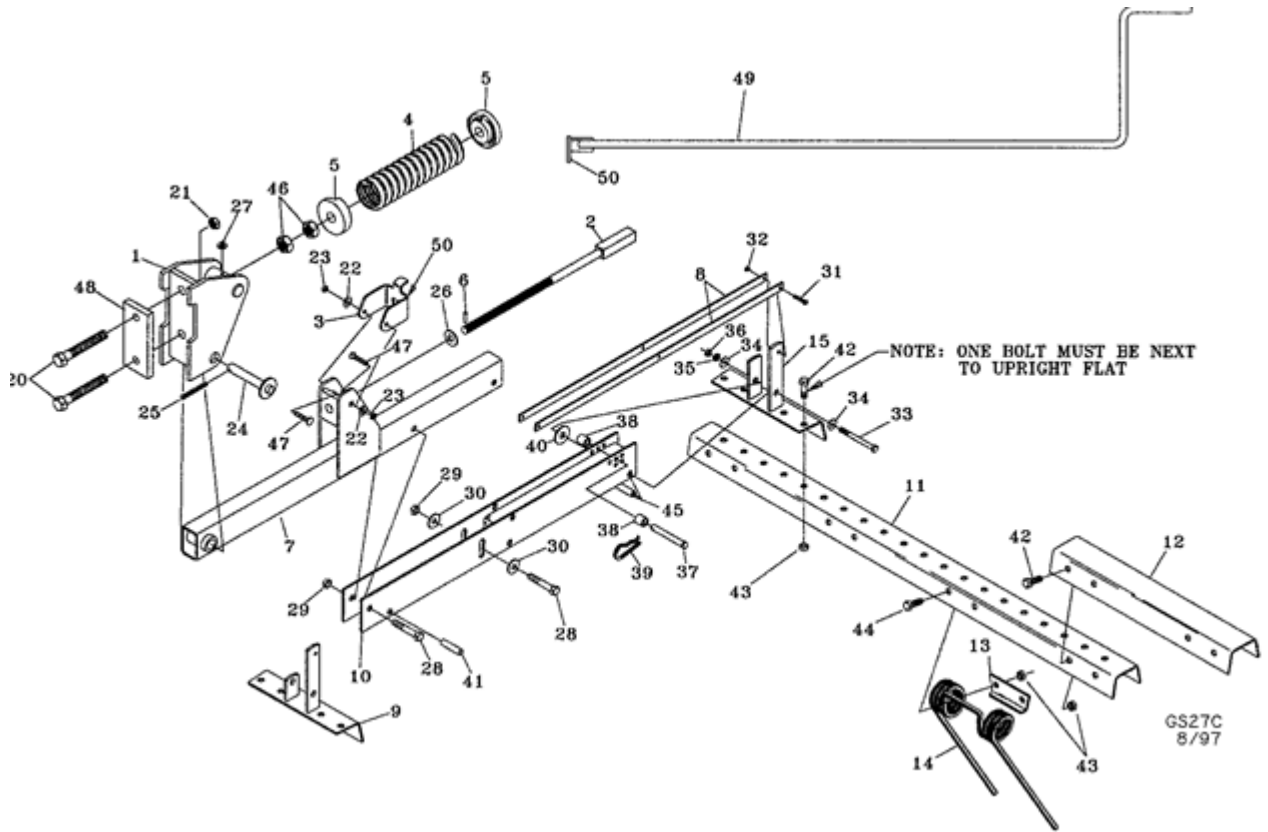

200 : TIGER-MATE CASE IH FIELD CULTIVATOR

75.200.04 - COIL TINE HARROW

Ссылка	Кол-во	Номер по каталогу	Описание	ОН	Индикаторы
1	2	06251376	BRACKET Mounting		
2	2	06251351	ROD, THREADED 7/8		
2	2	06250347	ROD, THREADED 3/4, Used On Earlier Models		
3	2	06251316	LOCKING DEVICE		
6	2	38-1816	PIN, LOCK 1/8" x 1", Slotted,		
4	2	24143902	SPRING, COMPRESSION		
5	2	20090105	SEAT, SPRING Spring Holder		
7	2	06251341	TUBE ASSY.		
8	4	06250358	LINK Tine		
9	4	06250150	CHANNEL Mount		
10	2	06251331	LINKAGE Pivot		
11	3	06250041	CHANNEL 4 Tine, 53 Inch		
11	3	06250051	CHANNEL 5 Tine, 68 Inch		
11	3	06250061	CHANNEL 6 Tine, 83 Inch		
11	3	06250071	CHANNEL 7 Tine, 98 Inch		
11	3	06250081	CHANNEL 8 Tine, 113 Inch		
11	3	06250091	CHANNEL 9 Tine, 128 Inch		
11	3	06250104	CHANNEL 10 Tine, 143 Inch		
12	UAR	06250180	CHANNEL Splice		
13	UAR	06250200	CLAMP		
14	UAR	33404416	TINE Coil		
15	2	06250155	CHANNEL Rear, Mount		
20	4	413-1288	BOLT Hex, 3/4"-10 x 5 1/2", G5,		
21	4	280375	NUT, LOCK 3/4"-10, GC,		
22	2	80681	WASHER, LOCK 5/16",		
23	2	86992212	NUT, LOCK 5/16, NC, Stover		
24	2	14816331	PIN, CLEVIS 1 x 4-1/8, EL		
25	2	432-2032	PIN, SPLIT (COTTER) 5/16" x 2",		
26	2	17614030	BUSHING 7/8, Machine		
27	2	219-87	NIPPLE, LUBE 1/4"-28 x .56" lg, Self-Tap,		
28	4	413-848	BOLT Hex, 1/2"-13 x 3", G5,		
29	4	425-108	NUT 1/2"-13, G5,		
30	4	495-21056	WASHER 1/2",		
31	6	413-628	BOLT Hex, 3/8"-16 x 1 3/4", G5,		
32	6	87039402	NUT, LOCK 3/8"-16, GB,		
33	6	413-664	BOLT Hex, 3/8"-16 x 4", G5,		
34	12	80702	WASHER 3/8",		
35	6	80680	WASHER, LOCK 3/8",		
36	6	425-106	NUT 3/8"-16, G5,		
37	2	14810290	PIN, HEADED 5/8 x 4.4 EL, Clevis		
38	4	06250210	BUSHING Stop		
39	2	14720411	PIN, SPLIT (COTTER) 1/8 x 2, Hair		
40	6	80299	WASHER 5/8", Flat		
41	4	06250170	SPACER Pivot		
42	UAR	413-820	BOLT Hex, 1/2"-13 x 1 1/4", G5, Full Thd,		

200 : TIGER-MATE CASE IH FIELD CULTIVATOR

75.200.04 - COIL TINE HARROW

Ссылка	Кол-во	Номер по каталогу	Описание	ОН	Индикаторы
43	UAR	87333862	NUT, LOCK		
44	UAR	413-824	BOLT Hex, 1/2"-13 x 1 1/2", G5, Full Thd,		 
45	2	06250190	BUSHING Pivot		
46	4	425-1014	NUT 7/8"-9, G5,		 
47	2	434-516	BOLT, CARRIAGE Short NK, 5/16"-18 x 1", G5, Full Thd,		
48	2	06250334	SPACER		
49	1	06251395	CRANK Adjustment		
50	2	18534332	DECAL Raise Decal		

200 : TIGER-MATE CASE IH FIELD CULTIVATOR



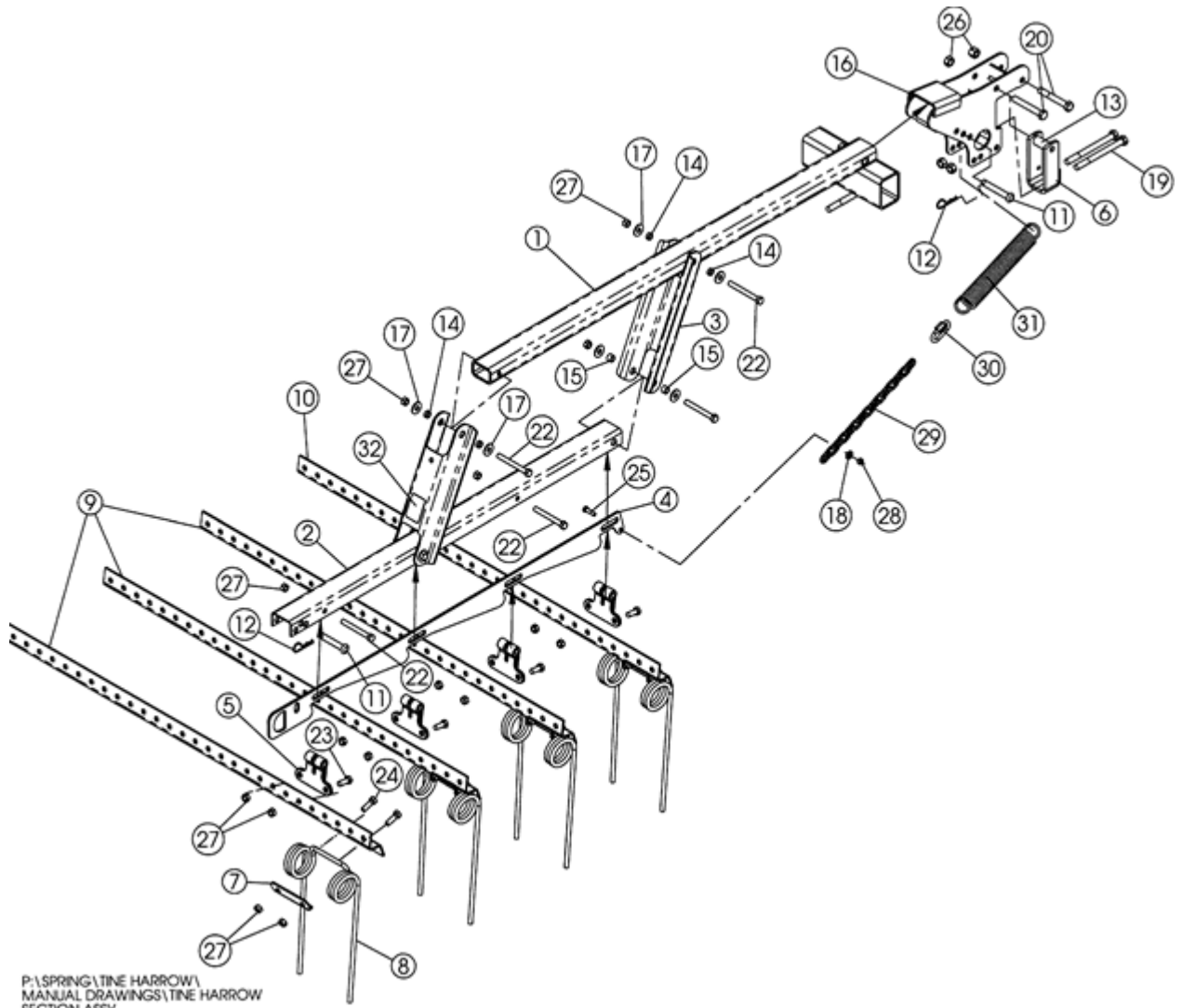





















75.200.05 - TIGER TINE HARROW PARTS



P:\SPRING\TINE HARROW\
MANUAL DRAWINGS\TINE HARROW
SECTION ASSY



























200 : TIGER-MATE CASE IH FIELD CULTIVATOR

75.200.05 - TIGER TINE HARROW PARTS

Ссылка	Кол-во	Номер по каталогу	Описание	ОН	Индикаторы
1	2	06404160	TUBE Mount Extension		
2	2	87457440	CHANNEL Formed, New Arms And Bushings Are Needed Due To Change In Hole Size		 
3	4	06404110	ARM, LIFT Parallel, 14-1/2, Used On Prior To 2005 Models		
3	4	87457435	ARM Parallel, 14-1/2		
4	2	06404120	ADJUSTER Tine, Slide		
5	8	06404136	HINGE Tine Hinge Casting		
6	2	06405130	CLAMP 2, Bolt		
7	UAR	06404220	CHANNEL Tine, 8		
8	UAR	33443707	TINE 8, Coil		 
9	3	06404175	CHANNEL Tine, 4 On 16 Spacing, 3 On 24 Spacing, 56 Inches		
9	3	06404185	CHANNEL Tine, 5 On 16 Spacing, 72 Inches		
9	3	06404195	CHANNEL Tine, 6 On 16 Spacing, 88 Inches		
9	3	06404205	CHANNEL Tine, 7 On 16 Spacing, 5 On 24 Spacing, 104 Inches		
9	3	06404215	CHANNEL Tine, 8 On 16 Spacing, 120 Inches		
10	1	06404325	TINE BAR Tine, 2 On 24 Spacing, 32 Inches		
10	1	06404175	CHANNEL Tine, 4 On 16 Spacing, 3 On 24 Spacing, 56 Inches		
10	1	06404345	CHANNEL Tine, 4 On 24 Spacing, 80 Inches		
10	1	06404205	CHANNEL Tine, 7 On 16 Spacing, 5 On 24 Spacing, 104 Inches		
10	1	06404365	TINE BAR Tine, 6 On 24 Spacing, 128 Inches		
11	4	14810275	CLEVIS 5/8 x 4, Clevis		 
12	4	14720411	PIN, SPLIT (COTTER) 1/8 x 2, Hair		 
13	2	06405140	PLUG Bushing		
14	8	06404106	SLEEVE Sleeve, Used On Prior To 2005 Models		
14	8	87457432	BUSHING Sleeve, H.T.		
15	8	06404112	PLUG Pivot, Used On Prior To 2005 Models		
15	8	87457434	BUSHING Pivot		
16	1	87453778	MOUNTING PARTS		
17	16	80700	WASHER 1/2",		  
18	2	17407015	WASHER 7/16 x 1/8, Thick		 
19	4	280293	BOLT Hex, 5/8"-11 x 7", G5,		 
20	4	413-1068	BOLT Hex, 5/8"-11 x 4 1/4", G5,		 

200 : TIGER-MATE CASE IH FIELD CULTIVATOR

75.200.05 - TIGER TINE HARROW PARTS

Ссылка	Кол-во	Номер по каталогу	Описание	ОН	Индикаторы
22	2	413-868	BOLT Hex, 1/2"-13 x 4 1/4", G5,		 
23	2	413-820	BOLT Hex, 1/2"-13 x 1 1/4", G5, Full Thd,		 
24	UAR	413-824	BOLT Hex, 1/2"-13 x 1 1/2", G5, Full Thd,		 
25	2	413-620	BOLT Hex, 3/8"-16 x 1 1/4", G5, Full Thd,		  
26	8	85700693	NUT, LOCK 5/8"-11, GC,		 
27	UAR	86992215	NUT, LOCK 1/2"-13, GC, Stover		  
28	4	86992213	NUT, LOCK 3/8, NC, Stover		 
29	2	22004161	CHAIN 1/4 x 19-1/2		 
30	2	22105011	LINK ASSY. 5/16, Quick		 
31	2	24320010	SPRING 9, Extension, Used On 2004 And Prior Models		
31	2	87453100	SPRING, COIL 13, Extension, Used On 2005 Models		 
32	2	18534380	DECAL Tine Angle		
33	2	413-624	BOLT Hex, 3/8"-16 x 1 1/2", G5,		  
34	1	87405850	SPRING Spring And Chain, Inc. 18, 28 - 31, And 33, Used On 2004 Models And Prior		
35	1	87454585	KIT Tine Mount Adapter, Enough To Do One Harrow Section		

200 : TIGER-MATE CASE IH FIELD CULTIVATOR

75.200.06 - TINE ADJUSTMENT HANDLE STORAGE

DOUBLE FOLD UNITS

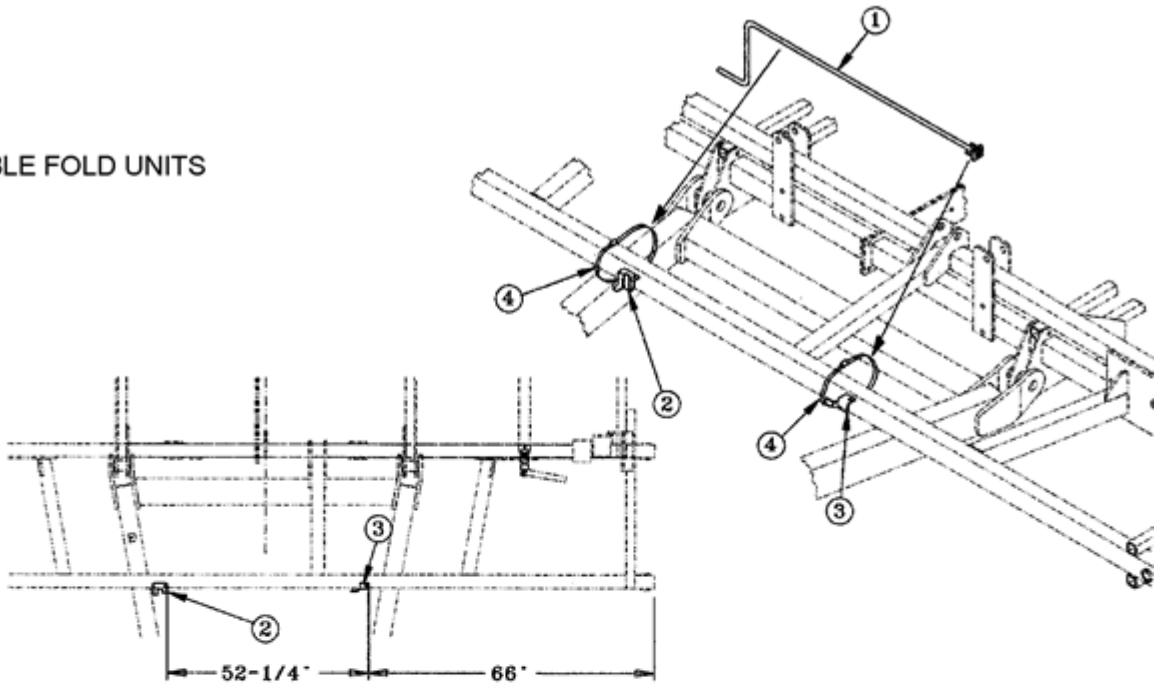

SINGLE FOLD UNITS

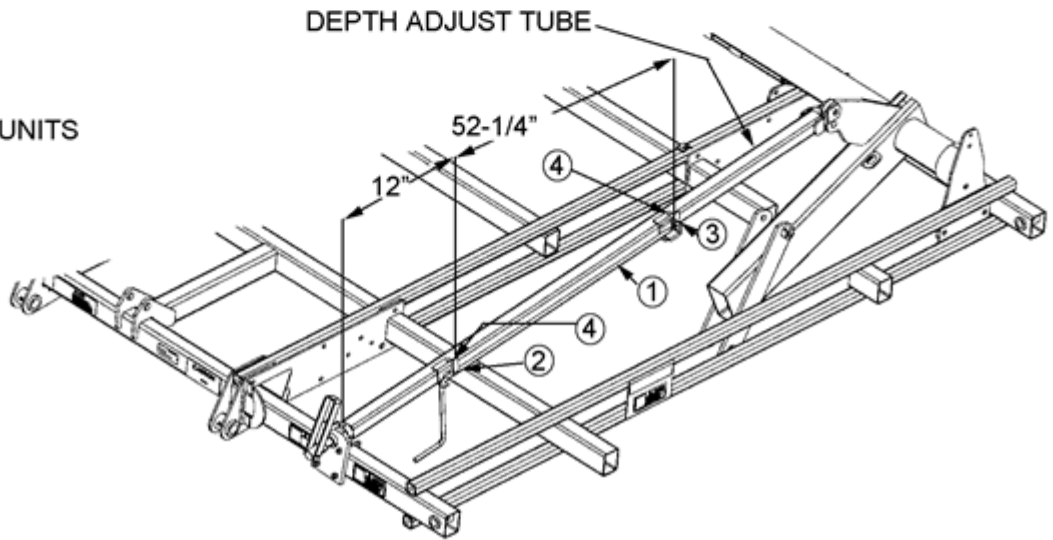

GS08A009

200 : TIGER-MATE CASE IH FIELD CULTIVATOR

75.200.06 - TINE ADJUSTMENT HANDLE STORAGE

Ссылка	Кол-во	Номер по каталогу	Описание	ОН	Индикаторы
1	1	06250395	CRANK Tine Adjustment		
2	1	06250398	CRANK Clip, Front Hanger		
3	1	06250399	CRANK Clip, Rear Hanger		
4	2	214-1432	CLAMP, HOSE #32, 1.56/2.50 Type F Worm,		





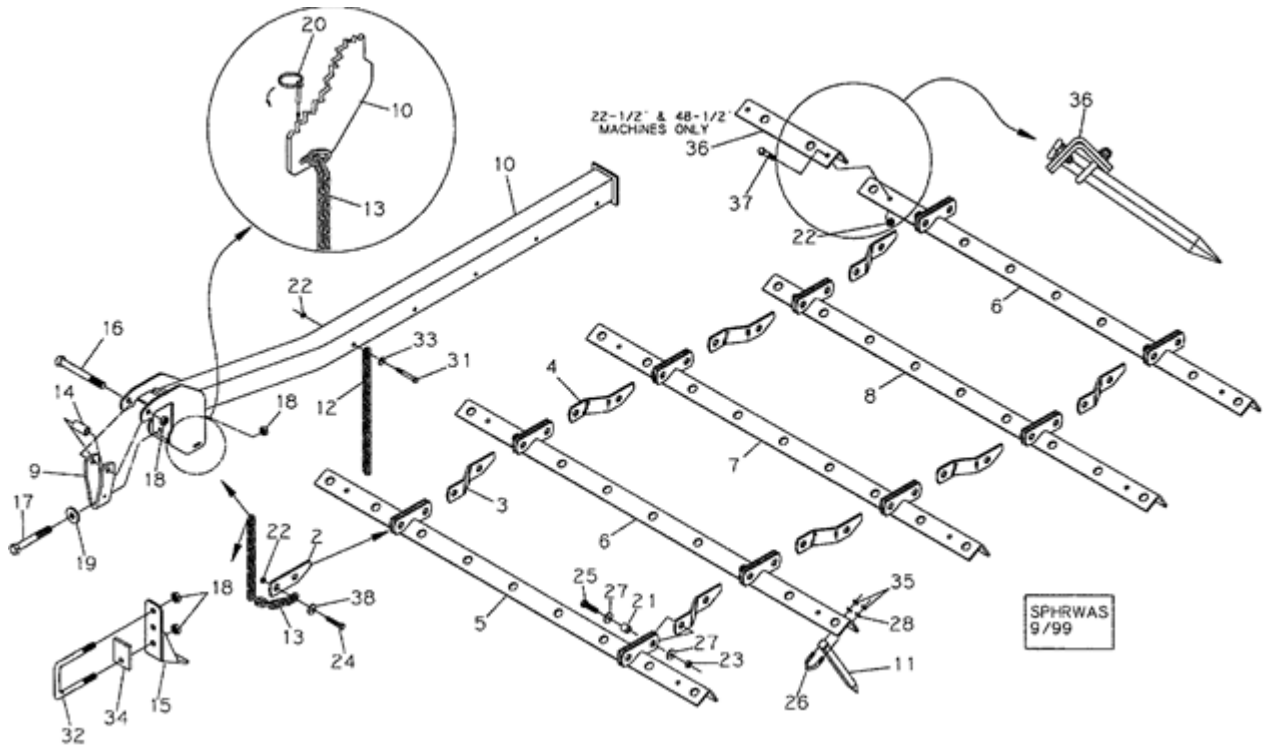



200 : TIGER-MATE CASE IH FIELD CULTIVATOR

75.200.07 - SPIKE TOOTH HARROW















































200 : TIGER-MATE CASE IH FIELD CULTIVATOR

75.200.07 - SPIKE TOOTH HARROW

Ссылка	Кол-во	Номер по каталогу	Описание	ОН	Индикаторы
2	2	06260050	LINK Straight		
3	4	06260068	LINK Rh		
4	4	06260069	LINK Lh		
5	1	06260061	CHANNEL 6-Spike, First Bar, 40.50 Inches		
5	1	06260071	CHANNEL 7-Spike, First Bar, 48 Inches		
5	1	06260091	CHANNEL 9-Spike, First Bar, 63 Inches		
5	1	06260111	CHANNEL 11-Spike, First Bar, 78 Inches		
5	1	06260121	CHANNEL 12-Spike, First Bar, 85.50 Inches		
6	2	06260062	CHANNEL 6-Spike, Second And Fifth Bar, 40.50 Inches		
6	2	06260072	CHANNEL 7-Spike, Second And Fifth Bar, 48 Inches		
6	2	06260092	CHANNEL 9-Spike, Second And Fifth Bar, 63 Inches		
6	2	06260112	CHANNEL 11-Spike, Second And Fifth Bar, 78 Inches		
6	2	06260122	CHANNEL 12-Spike, Second And Fifth Bar, 85.50 Inches		
7	1	06260063	CHANNEL 6-Spike, Third Bar, 40.50 Inches		
7	1	06260073	CHANNEL 7-Spike, Third Bar, 48 Inches		
7	1	06260093	CHANNEL 9-Spike, Third Bar, 63 Inches		
7	1	06260113	CHANNEL 11-Spike, Third Bar, 78 Inches		
7	1	06260123	CHANNEL 12-Spike, Third Bar, 85.50 Inches		
8	1	06260064	BAR 6-Spike, Fourth Bar, 40.50 Inches		
8	1	06260074	CHANNEL 7-Spike, Fourth Bar, 48 Inches		
8	1	06260094	CHANNEL 9-Spike, Fourth Bar, 63 Inches		
8	1	06260114	CHANNEL 11-Spike, Fourth Bar, 78 Inches		
8	1	06260124	CHANNEL 12-Spike, Fourth Bar, 85.50 Inches		
9	2	06405150	CLAMP Mount		
10	2	87646404	ARM Spike Harrow		
11	UAR	33407513	SHOVEL Spike		
12	10	22004161	CHAIN 1/4 x 19-1/2, Lift		 
13	2	22004341	CHAIN 1/4 x 34-3/4, Pull		
14	2	06405140	PLUG Spacer		
15	UAR	06406050	BRACKET Tow Chain		
16	2	413-1072	BOLT Hex, 5/8"-11 x 4 1/2", G5,		  

200 : TIGER-MATE CASE IH FIELD CULTIVATOR

75.200.07 - SPIKE TOOTH HARROW

Ссылка	Кол-во	Номер по каталогу	Описание	ОН	Индикаторы
17	2	413-10104	BOLT Hex, 5/8"-11 x 6 1/2", G5,		
18	UAR	85700693	NUT, LOCK 5/8"-11, GC,		 
19	2	87613192	WASHER		
20	4	A30338	PIN 1/4 x 1-3/4, Klik		  
21	18	02323001	BUSHING Heat Treated		
22	12	86992213	NUT, LOCK 3/8, NC, Stover		 
23	18	86992215	NUT, LOCK 1/2"-13, GC, Stover		  
24	2	413-620	BOLT Hex, 3/8"-16 x 1 1/4", G5, Full Thd,		   
25	18	413-828	BOLT Hex, 1/2"-13 x 1 3/4", G5,		  
26	UAR	16306050	U-BOLT 3/8 x 1-1/16 x 2-1/8		
27	40	80700	WASHER 1/2",		  
28	UAR	80680	WASHER, LOCK 3/8",		 
30	4	425-1010	NUT 5/8"-11, G5,		   
31	10	413-664	BOLT Hex, 3/8"-16 x 4", G5,		 
32	2	87629089	U-BOLT		
33	12	80702	WASHER 3/8",		   
34	UAR	06406040	BAR Spacer, Used On Double Fold Models 38-1/2 Through 60-1/2		
35	UAR	425-106	NUT 3/8"-16, G5,		   
36	UAR	06406030	CHANNEL Spike Extension		
37	UAR	413-616	BOLT Hex, 3/8"-16 x 1", G5, Full Thd,		   
38	2	17407015	WASHER 7/16 ID x 1/8, Thick		 
39	1	06406300	KIT Anti-Tangle Chain (Not Shown)		





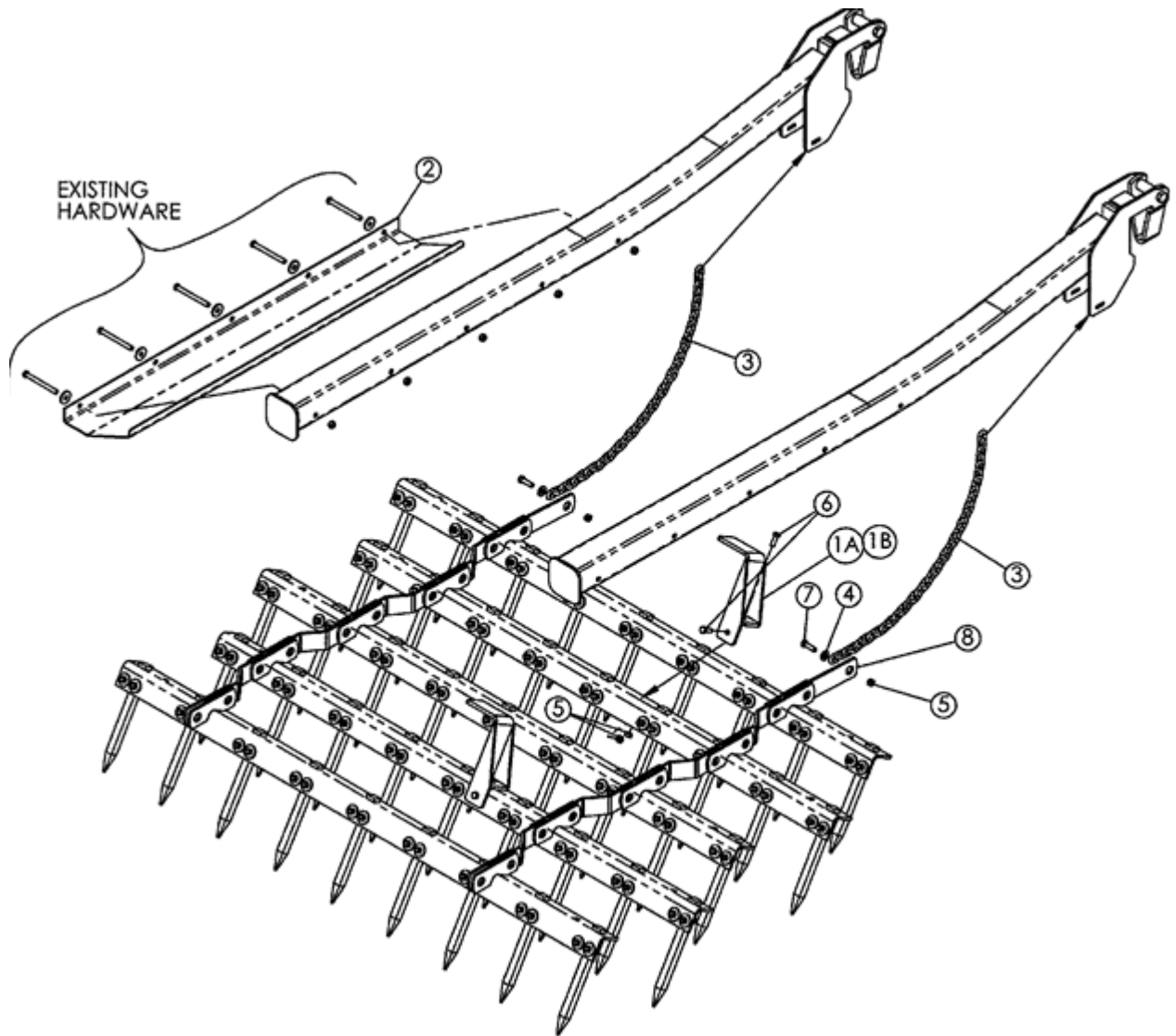



200 : TIGER-MATE CASE IH FIELD CULTIVATOR

75.200.08 - SPIKE ANTI-ANGLE KIT



200 : TIGER-MATE CASE IH FIELD CULTIVATOR

75.200.08 - SPIKE ANTI-ANGLE KIT

Ссылка	Кол-во	Номер по каталогу	Описание	ОН	Индикаторы
1A	1	06406340	BRACKET Catch, Lh		
1B	1	06406350	BRACKET Catch, Rh		
2	2	06406217	LINKAGE Slide		
3	2	22004341	CHAIN 1/4 x 34-1/2		
4	2	17407015	WASHER 7/16 x 1/8, Thick		 
5	6	86992213	NUT, LOCK 3/8, NC, Stover		 
6	2	413-616	BOLT Hex, 3/8"-16 x 1", G5, Full Thd,		   
7	2	413-620	BOLT Hex, 3/8"-16 x 1 1/4", G5, Full Thd,		  
8	2	06260050	LINK Straight		
9	1	06406300	KIT Spike Harrow, Inc. 1A - 8		

200 : TIGER-MATE CASE IH FIELD CULTIVATOR

90.108.02.01 - DECALS

tiger-mate II. CASE III

1

CASE III tiger-mate II.

2

CASE III tiger-mate II.

3

tiger-mate II. CASE III

4

200 CASE III
TIGER-MATE

5

CASE III 200
TIGER-MATE

6

200 : TIGER-MATE CASE IH FIELD CULTIVATOR

90.108.02.01 - DECALS

Ссылка	Кол-во	Номер по каталогу	Описание	ОН	Индикаторы
1	1	87348169	DECAL Tiger-mate		
2	1	87348172	DECAL Tiger-mate		
3	1	18535012	DECAL Tiger-mate		
4	1	18535011	DECAL Tiger-mate		
5	1	87638241	DECAL Tiger-mate		
6	1	87638244	DECAL Tiger-mate		
7	2	87594280	DECAL Case IH, Not Shown		

200 : TIGER-MATE CASE IH FIELD CULTIVATOR

90.108.02.02 - TIGERMATE 200 DECALS



1



2



3

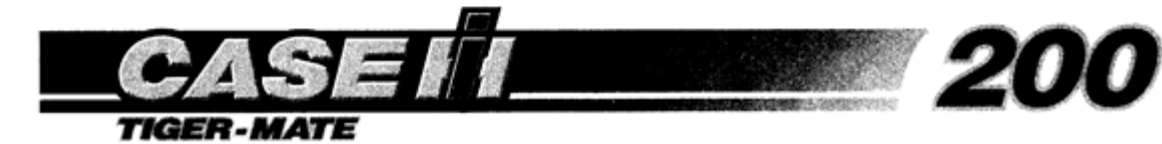

4

200 : TIGER-MATE CASE IH FIELD CULTIVATOR

90.108.02.02 - TIGERMATE 200 DECALS

Ссылка	Кол-во	Номер по каталогу	Описание	ОН	Индикаторы
1	1	87735849	DECAL		
2	1	87735850	DECAL		
3	1	87735851	DECAL		
4	1	87735852	DECAL		

200 : TIGER-MATE CASE IH FIELD CULTIVATOR

90.108.03.01 - DECALS

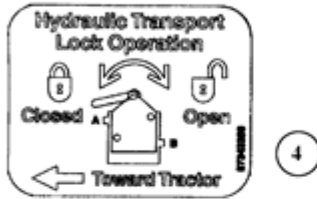
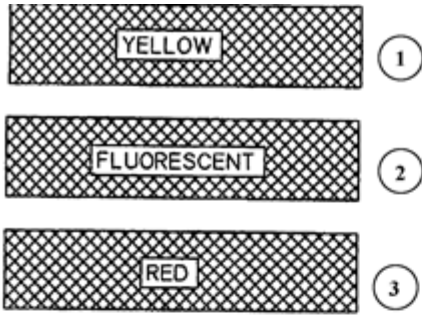

Leveling	Residue	Tine Angle Hole	Spring Link Hole
More —	Light	Front —	Rear
Moderate —	Moderate	Center —	Center
Less —	Heavy	Rear —	Front

• Must change spring link setting when tine angle is changed.

18534380

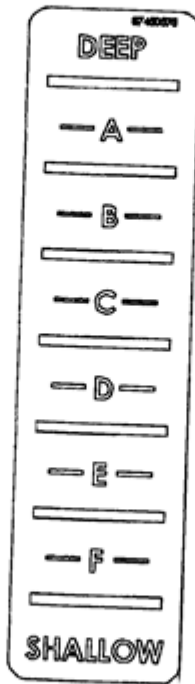
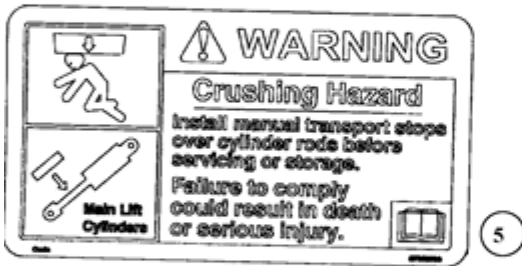

Basket Down Pressure Adjustment

Basket Length	Down Pressure (lbs/ft)		
	80 lbs	70 lbs	60 lbs
60"	17.00"	18.00"	18.00"
70"	18.50"	18.00"	18.00"
80"	18.50"	18.00"	18.00"
100"	18.00"	18.00"	14.50"
120"	18.00"	14.75"	14.00"

Set spring assembly (A) per chart to maintain equal down pressure on all baskets.

To adjust spring length:
 1) Loosen jam nut (B)
 2) Hold bolt (C)
 3) Adjust main spring nut (D) to desired length.





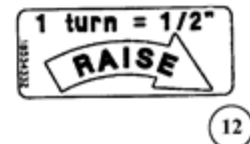



To raise (disengage) basket:
 Turn spring bolt (C) to lift basket arm off crate stop.

18534381



200 : TIGER-MATE CASE IH FIELD CULTIVATOR

90.108.03.01 - DECALS

Ссылка	Кол-во	Номер по каталогу	Описание	ОН	Индикаторы
1	1	311864A1	REFLECTOR Yellow		  
2	1	311865A1	REFLECTOR Fluorescent		  
3	1	311863A1	REFLECTOR Red		  
4	1	87343258	DECAL Hydraulic Transport		
5	1	87353780	DECAL Crushing Hazard		
6	1	87353782	DECAL Transport Hazard		
7	1	87450575	DECAL Depth Indicator		
8	1	18534307	DECAL Helping Plants Thrive		
9	1	18534308	DECAL Depth Control		
10	1	18534380	DECAL Tine Angle		
11	1	18534381	DECAL Information		
12	1	18534332	DECAL Depth Adjust		

200 : TIGER-MATE CASE IH FIELD CULTIVATOR

90.108.03.02 - DECALS

1

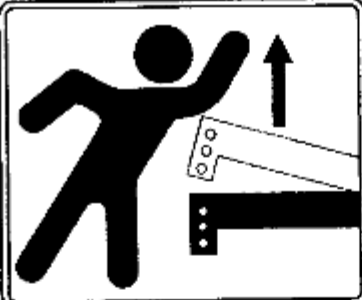

⚠ WARNING

UNHITCHING HAZARD
Tongue raises rapidly when unhitched. To avoid bodily injury, lower implement to ground before unhitching.

18534140

2



⚠ DANGER

CRUSHING HAZARD
To avoid injury or death keep everyone clear of machine when folding or unfolding wings

18534227

3

⚠ CAUTION

Failure to observe Instructions and Safety practices can result in serious Bodily Injury.

To avoid injury:

- Read and understand your Operators Manual before servicing or operating the machine.
- Learn to operate and adjust the machine safely.
- Do not allow anyone to ride on the machine or tractor.
- install all hydraulic cylinder stops and retract hydraulic cylinders before servicing or transporting machine.
- Make certain that everyone is clear before moving the Machine, Hydraulics, or any Component.

18534228

4

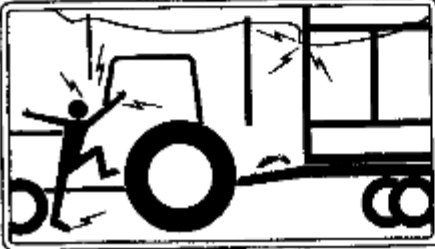

⚠ DANGER





ELECTROCUTION HAZARD
To avoid Injury or Death, DO NOT come into contact with overhead power lines

18534270

2

200 : TIGER-MATE CASE IH FIELD CULTIVATOR

90.108.03.02 - DECALS

Ссылка	Кол-во	Номер по каталогу	Описание	ОН	Индикаторы
1	1	18534140	DECAL, WARNING Unhitching Hazard		
2	1	18534227	DECAL, DANGER Crushing Hazard		 
3	1	18534228	DECAL Caution		 
4	1	18534275	DECAL, DANGER Electrocution Hazard		

200 : TIGER-MATE CASE IH FIELD CULTIVATOR

90.108.03.03 - DECALS

1

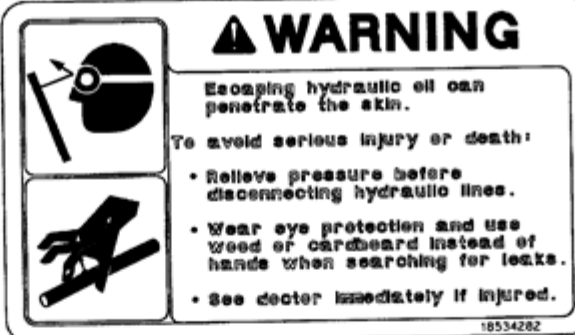

⚠ WARNING

Escaping hydraulic oil can penetrate the skin.

To avoid serious injury or death:

- Relieve pressure before disconnecting hydraulic lines.
- Wear eye protection and use wood or cardboard instead of hands when searching for leaks.
- See doctor immediately if injured.

18534282

2

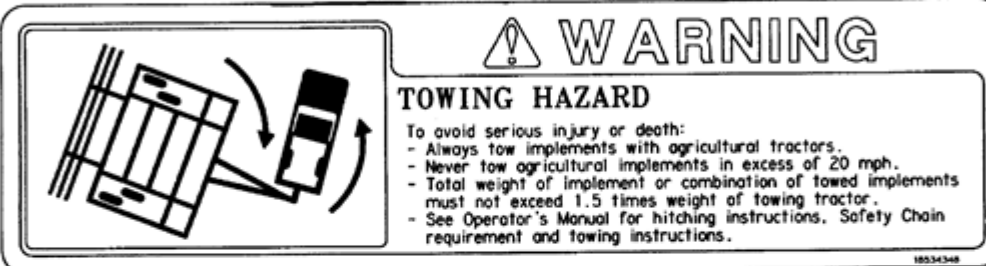

⚠ WARNING

TOWING HAZARD

To avoid serious injury or death:

- Always tow implements with agricultural tractors.
- Never tow agricultural implements in excess of 20 mph.
- Total weight of implement or combination of towed implements must not exceed 1.5 times weight of towing tractor.
- See Operator's Manual for hitching instructions, Safety Chain requirement and towing instructions.

18534348

3

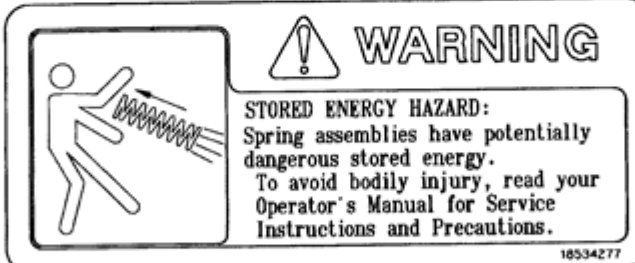

⚠ WARNING

STORED ENERGY HAZARD:
Spring assemblies have potentially dangerous stored energy.

To avoid bodily injury, read your Operator's Manual for Service Instructions and Precautions.

18534277

4

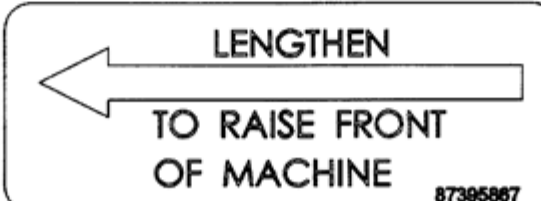

← LENGTHEN

TO RAISE FRONT OF MACHINE

87395867

200 : TIGER-MATE CASE IH FIELD CULTIVATOR

90.108.03.03 - DECALS

Ссылка	Кол-во	Номер по каталогу	Описание	ОН	Индикаторы
1	1	18534282	DECAL, WARNING Warning		
2	1	18534348	DECAL Towing Hazard		
3	1	18534277	DECAL Stored Energy		
4	1	87395867	DECAL Raise Unit		