



Ersatzteilliste

Parts list

Grubber

Cultivators

Smaragd 9/600 KA "B"

Art.-Nr. 175 1700

11.04

LEMKEN GmbH & Co. KG

Weseler Straße 5, D-46519 Alpen / Postfach 11 60, D-46515 Alpen

Telefon (0 28 02) 81-0, Telefax (0 28 02) 81-220

eMail: lemken@lemken.com, Internet: <http://www.lemken.com>

Smaragd 9/600 KA "B"

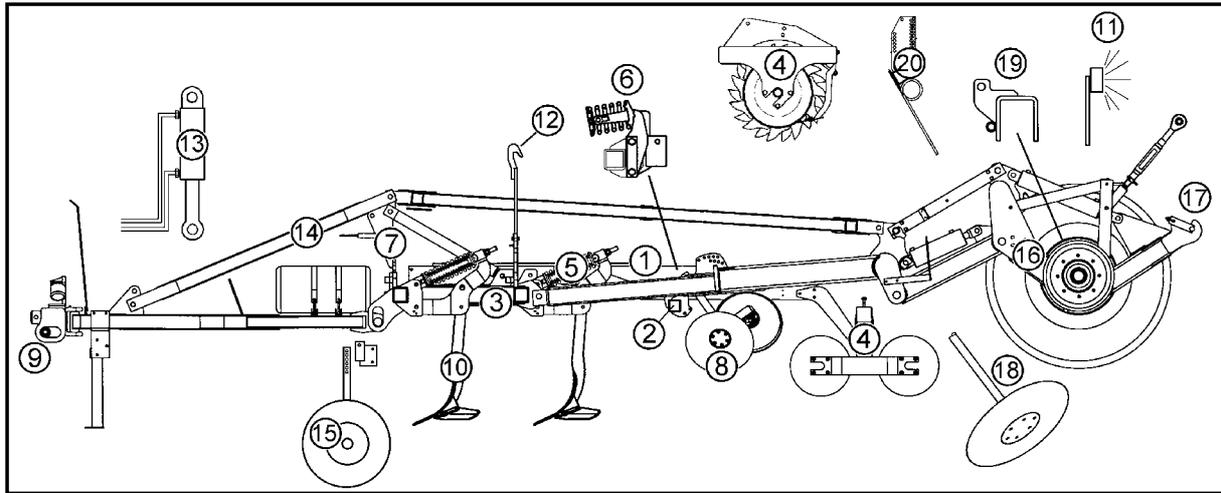

Pos	Art.-Nr.	Artikeltext / Description	Abmessung	Seite	
1	617 8078	Träger 1Paar	Carrier, 1 pair	120x2095-80x20 Smaragd 9 KÜ	6
1	617 8082	Träger 1Paar U-Form	Carrier, 1 pair U-shape	120x2095-80-60 SM9KAÜ	7
1	617 8084	Träger 1Paar U-Form	Carrier, 1 pair U-shape	120x2095-80-60 SM9KAÜ D600	8
1	617 8086	Träger 1Paar	Carrier, 1 pair	120x1795-80x20 Smaragd 9 K	9
1	617 8089	Träger 1Paar	Carrier, 1 pair	120x1795-100x20 SM9K-D600	10
1	617 8090	Träger 1Paar	Carrier, 1 pair	120x2095-100x20 SM9ÜK-D600	11
1	617 8124	Träger-T z. Doppelwalze	Carrier-T for double roller	1795 Smaragd 9 K	12
1	617 8125	Träger-T z. Doppelwalze	Carrier-T for double roller	2095 Smaragd 9 K	13
2	617 8162	Tragrohr für Hohlscheiben	Frame for hollow discs	2x SM9/600	14
3	617 8131	Waagebalken	Balance bar	S9/600 K	15
3	690 1201	Beipackteile	Fittings for AHG	Smaragd 9	16
3	690 1202	Beipackteile	Fittings for AHG	Smaragd 90Ü+100Ü	17
3	690 1203	Zubehör	Accessories	Smaragd 9 K(Ü)AB	18
3	690 1204	Beipackteile	Fittings for AHG	Smaragd 9Ü D30G	19
4	617 8188	Adapter	Adapter-inner thread	ZPW-SM9/600-K RE+LI	20
4	617 8216	Grundrahmen	Basic frame	Smaragd 9/600-K	21
4	622 0184	Halter zur Gummiringwalze	Holder	GRW-GR D590-90	22
4	622 6345	Zahnpackerwalze	Packer roller	ZPW D500-3,0m	23
4	622 6602	Rohrstabwalze	Tube bar roller	D400-300 SM9 K	24
4	622 6608	Rohrstabwalze	Tube bar roller	D540-300 RE SM9	25
4	622 6609	Rohrstabwalze	Tube bar roller	D540-300 LI SM9	26
4	622 6628	Rohrstabwalze	Tube bar roller	D600-300 SM9-K RE	27
4	622 6629	Rohrstabwalze	Tube bar roller	D600-300 SM9-K LI	28
4	622 6688	Doppelwalze Rohr-Flachstab	Double roller	D400-300 RE SM9K	29
4	622 6689	Doppelwalze Rohr-Flachstab	Double roller	D400-300 LI SM9K	30
4	622 6706	Doppelwalze Rohr-Rohr	Double roller	D400-300 RE SM9K	31
4	622 6707	Doppelwalze Rohr-Rohr	Double roller	D400-300 LI SM9K	32
4	622 6739	Trapezpackerwalze	Trapeze packer roller	TPW D500-300-24R-125	33
4	622 6744	Zahnpackerwalze kurz.Abstreif.	Packer roller, short scraper	ZPW D500-3,0m	34
4	622 6752	Trapezpackerwalze	Trapeze packer roller	TPW D500-300-20R150	35
4	622 6760	Trapezpackerwalze	Trapeze packer roller	TPW D500-300-17R175	36
4	622 6767	Trapezscheibenwalze	Trapeze disc roller	TSW D500-400-32R-125	37
4	622 6810	Messerwalze	Knife roller	MSW D600-300 RE SM9	38
4	622 6811	Messerwalze	Knife roller	MSW D600-300 LI SM9	39
4	622 6820	Messerwalze lange Messer	Knife roller	MSW D600-300 RE SM9	40
4	622 6821	Messerwalze lange Messer	Knife roller	MSW D600-300 LI SM9	41
4	622 6858	Doppelwalze Rohr-Rohr	Double roller	D540/400-3.00 RE	42
4	622 6859	Doppelwalze Rohr-Rohr	Double roller	D540/400-3.00 LI	43

Smaragd 9/600 KA "B"

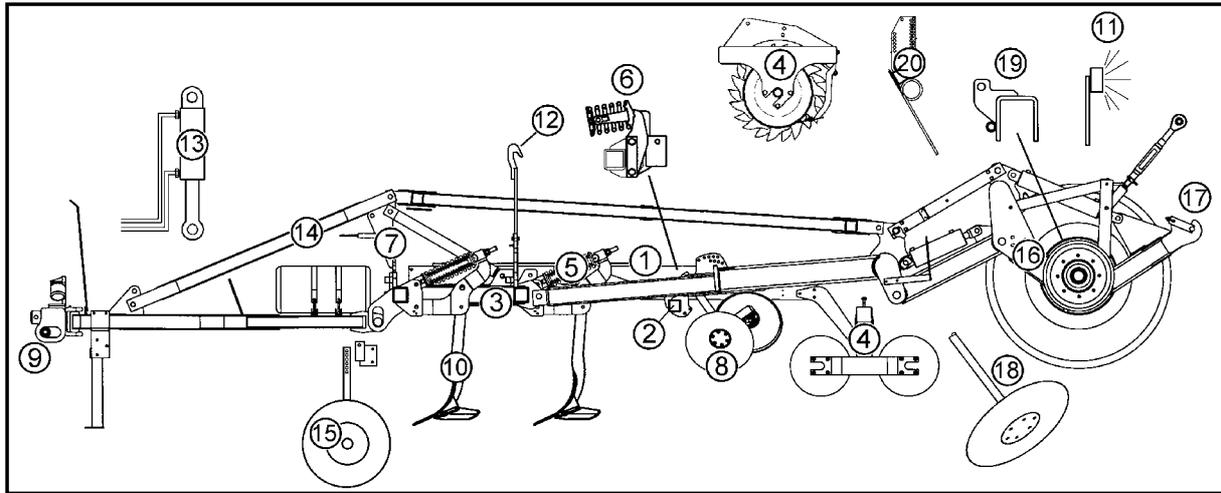

Pos	Art.-Nr.	Artikeltext / Description	Abmessung	Seite	
4	622 6873	Gummiringwalze	Rubber ring roller	GRW D590-300-24R-125	44
5	627 5687	Überlastsicherung	Trip device	100x22-A SM90+9	45
5	627 5720	Überlastsicherung	Trip device	D30G-16 SMARAGD 9	46
5	627 5726	Überlastsicherung	Trip device	D30G-20 206-Drehpunkt SM.9	47 .. 48
5	627 5728	Überlastsicherung	Trip device	D30G-20 150-Drehpunkt SM.9	49 .. 50
6	627 5695	Überlastsicherung	Trip device	50x18 SM9	51
7	640 5230	Geräteturm	Headstock	Smaragd 9 KA B -12.99	52
7	640 5231	Geräteturm	Headstock	Smaragd 9 KA B 01.00-	53
8	657 2418	Hohlscheibenpaar	Pair of hollow discs	2xD450 Smaragd 9	54
8	657 2420	Hohlscheibe	Hollow disc	RE D450 Smaragd 9	55
8	657 2421	Hohlscheibe	Hollow disc	LI D450 Smaragd 9	56
8	657 2424	Konsole zur Randscheibe	Bracket for outer disc	RE 80x80 SM9	57
8	657 2425	Konsole zur Randscheibe	Bracket for outer disc	LI 80x80 SM9	58
9	661 1354	Unterlenkeranschluß	Lower link connection	D55/68 L2 Z3	59
9	661 1372	Unterlenkeranschluß	Lower link connection	D68/68 L3 Z3	60
9	661 1380	Unterlenkeranschluß	Lower link connection	D68/68 L1100 Z58 K700	61
9	661 1411	Unterlenkeranschluß	Lower link connection	ED68/55 L2 Z2	62
9	661 1412	Unterlenkeranschluß	Lower link connection	ED68/55 L3 Z2	63
9	661 1413	Unterlenkeranschluß	Lower link connection	ED68 L2 Z3	64
9	661 1414	Unterlenkeranschluß	Lower link connection	ED68 L3 Z3	65
9	661 1417	Unterlenkeranschluß	Lower link connection	ED68 L1100 Z58 K700	66
9	661 6160	Tiefenbegrenzung	Depth limiter	K700 D68	67
9	661 6162	Tiefenbegrenzung	Depth limiter	K700 -B M30	68
10	665 3778	Zinken mit Flügelscharen	Tine with wing-shares	RE 480 S12P/FL37P-G 70x22 D24	69
10	665 3779	Zinken mit Flügelscharen	Tine with wing-shares	LI 480 S12P/FL37P-G 70x22 D24	70
10	665 3780	Zinken mit Flügelscharen	Tine with wing-shares	MI 480 S12P/FL37P-G 70x22 D24	71
10	665 3790	Zinken mit Flügelscharen	Tine with wing-shares	RE 480 S12PK/FL37P-G 70x22 D24	72
10	665 3791	Zinken mit Flügelscharen	Tine with wing-shares	LI 480 S12PK/FL37P-G 70x22 D24	73
10	665 3792	Zinken mit Flügelscharen	Tine with wing-shares	MI 480 S12PK/FL37P-G 70x22 D24	74
10	665 3908	Zinken mit Flügelscharen	Tine with wing-shares	RE 480 S12P/FL37P-G 70x22 D16	75
10	665 3909	Zinken mit Flügelscharen	Tine with wing-shares	LI 480 S12P/FL37P-G 70x22 D16	76
10	665 3910	Zinken mit Flügelscharen	Tine with wing-shares	MI 480 S12P/FL37P-G 70x22 D16	77
10	665 3920	Zinken mit Flügelscharen	Tine with wing-shares	RE 480 S12PK/FL37P-G 70x22 D16	78
10	665 3921	Zinken mit Flügelscharen	Tine with wing-shares	LI 480 S12PK/FL37P-G 70x22 D16	79
10	665 3922	Zinken mit Flügelscharen	Tine with wing-shares	MI 480 S12PK/FL37P-G 70x22 D16	80

Smaragd 9/600 KA "B"

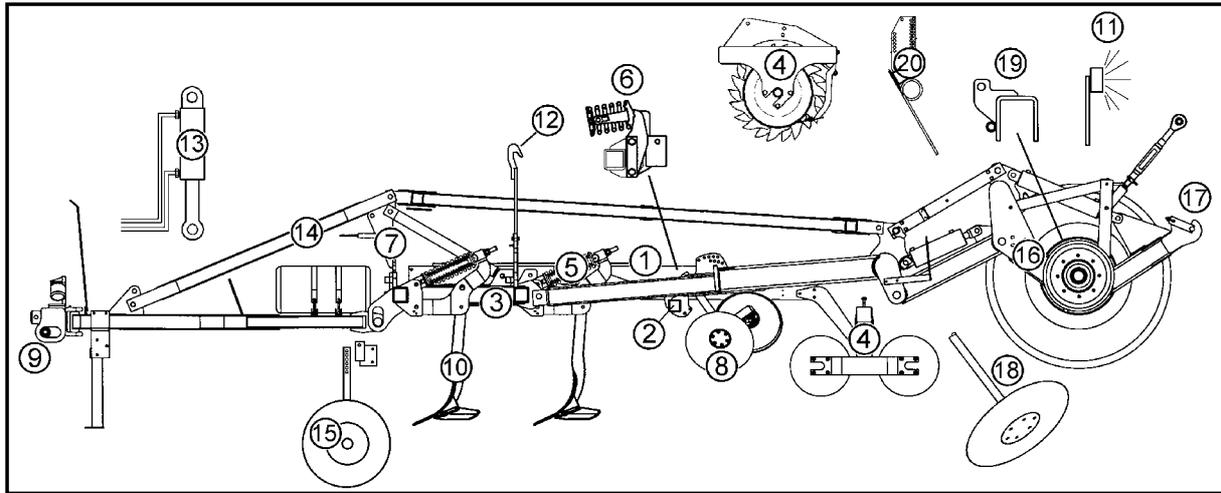

Pos	Art.-Nr.	Artikeltext / Description	Abmessung	Seite	
11	570 1902	Beleuchtungsanlage vorne	Lighting equipment, front	Smaragd 9 KA B	81
11	573 5080	Steuerbox	Control box	ELFG104-XXXX	82
11	573 5082	Kabelbaum	Cable form	ELFG104-XXXX 10m	83
11	670 1902	Beleuchtungsanlage ohne Halter	Lighting equipment	V Smaragd 9 KA B	84
11	670 1903	Beleuchtungsanlage mit Halter	Lighting equipment	V Smaragd 9 KA B	85
11	670 2007	Beleuchtungsanlage hinten	Lighting equipment, rear	KA 150x150	86
11	670 2009	Beleuchtungsanlage hinten	Lighting equipment, rear	KA 140x140	87
11	673 6032	Joystickbox	Joystickbox	JB-1	88
11	673 6163	Verlängerung	Extension	8m-10 Solitronic	89
12	617 8147	Verriegelung hydraulisch	Hydraulic locking device	Smaragd 9/400K-600K	90
13	575 2193	Steuerblock	Control valve	L8S-3D/1E	91
13	575 2200	Dreiwegedruckwaage	Three-way pressure balance	LU8SSCK-QM22/04	92
13	575 2201	Wegeventil	Valve	6/3 LD8SE4D2525	93
13	575 2211	Sitzventil	Seat valve	SVH04M878SA-OM14G12	94
13	575 6601	Adapter	Adapter-inner thread	K700	95
13	675 4366	Schlauchhalter	Hose carrier	D42,5x6,3x1740	96
13	675 5305	Hydraulikanlage Aushubgestänge	HY-assembly lift linkage	DZ 110x450	97
13	675 5306	Hydraulikanlage Aushubgestänge	HY-assembly lift linkage	DZ 110x450	98 .. 99
13	675 5398	Hydraulische Einklappung	HY-assembly folding device	Smaragd 9 KA B DZ110/450	100 .. 101
13	675 5399	Hydraulikleitungen Einklappung	HY-pipe assembly	Smaragd 9 KA B	102
13	675 5401	Hydraulische Einklappung	HY-assembly folding device	Smaragd 9 KA B DZ90/450	103 .. 104
13	675 5402	Hydraulikanlage Aufsattelung	HY-assembly trailer	Smaragd 9 KA B DZ100/245	105 .. 106
13	675 5403	Hydraulikanlage Aufsattelung	HY-assembly trailer	Smaragd 9 KA B DZ100/245	107 .. 108
13	675 5404	Hydraulikleitungen Klappung	HY-pipe assembly folding dev.	Smaragd 9 KA B	109
13	675 5405	Hydraulikleitungen Einklappung	HY-pipe assembly	Smaragd 9 KA B-6/2 W. AHG	140
13	675 5406	Hydraulikleitungen Aushubgest.	HY-pipe assembly	Smaragd 9 KA B	141
13	675 5407	Hydraulikleitungen Spuranreiß.	HY-pipe assembly	Smaragd 9 KA B	142
13	675 5408	Hydraulikleitungen Antrieb	HY-pipe assembly	Smaragd 9 KA B	143
13	675 5409	Hydraulikleitungen Antrieb	HY-pipe assembly	Smaragd 9 KA B	114
13	675 5410	Hydraulikanlage Steuerblock	HY-assembly control valve	Smaragd 9 KA B L8S	115
13	675 5411	Hydraulikanlage Steuerblock	HY-assembly control valve	Smaragd 9 KA B-FW	116 .. 117
13	675 5412	Hydraulikleitungen Steuerblock	HY-pipe assembly	Smaragd 9 KA B-K	118
13	675 5413	Hydraulikleitungen Steuerblock	HY-pipe assembly	Smaragd 9 KA B-SP	119
13	675 5414	Hydraulikleitungen Steuerblock	HY-pipe assembly	Smaragd 9 KA B-AHG	120
13	675 5418	Hydraulikanlage Spuranreißer	HY-assembly track marker	Smaragd 9 KA B 6m	121
13	675 5422	Hydraulikanlage Spuranreißer	HY-assembly track marker	Smaragd 9 KA B 6m	122
13	675 5423	Hydraulische Bremsanlage	Hydraulic braking assembly	Smaragd 9 KAB 2xEZ 30x110	123
13	675 5424	Transporthöhenbegrenzung	Transport height limiter	Smaragd 9/600 KAB D40	124
13	675 5425	Hydraulikleitung Aushubgest.	HY-pipe lifting device	Smaragd 9 KA B EW	125
13	675 7029	Hydraulikanlage Entriegelung	HY-assembly unlocking device	DZ25/18-240 SM9/500+600 K	126

Smaragd 9/600 KA "B"

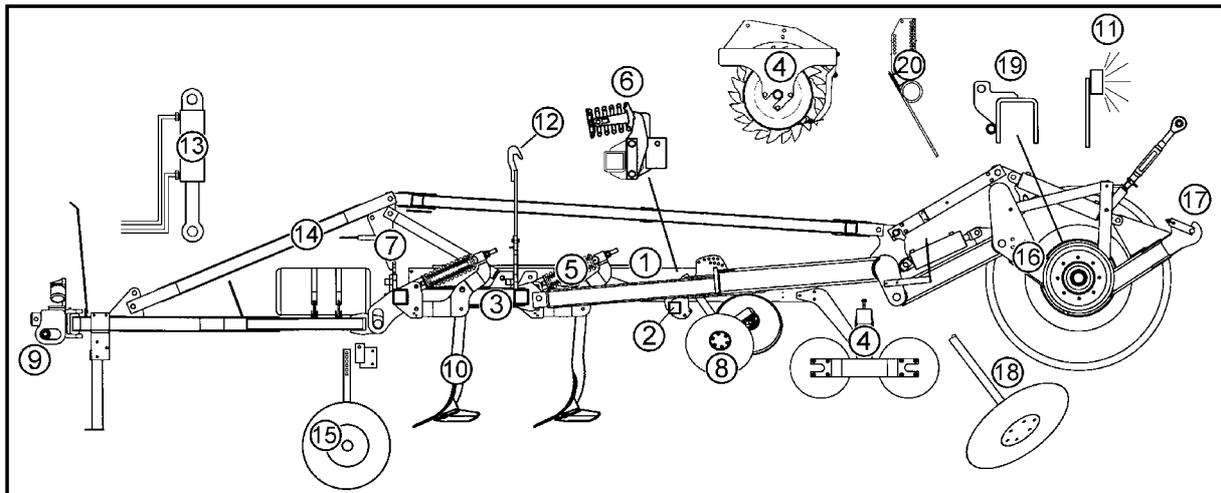

Pos	Art.-Nr.	Artikeltext / Description	Abmessung	Seite	
14	629 7120	Abstellstütze zur Deichsel	Stand	70x22/100x100x600	127
14	629 7121	Abstellstütze zur Deichsel	Stand	70x22/110x110x600	128
14	640 9130	Deichsel	Deichsel	100x100/Smaragd 9 KA-B -12.99	129 .. 130
14	640 9132	Deichsel	Deichsel	110x110/Sm.9 KA-B 01.00-04.03	131 .. 132
14	640 9139	Deichsel	Deichsel	110x110/Smaragd 9 KA-B KG45	133 .. 134
15	647 2520	Stützrad mit Halm	Depth wheel	10.0/80-12 70x30	135
15	647 7474	Radkonsole	Wheel bracket	70x30 RE Smaragd 9K	136
15	647 7475	Radkonsole	Wheel bracket	70x30 LI Smaragd 9K	137
16	549 8897	Lagerung	Bearing	8/220/275 M18 80x80	138
16	550 8517	Befestigungssatz	Set of fittings	M18x1,5 125/80-18	139
16	550 8518	Laufachse	Running axle	140x140x2530 8/220/275	140
16	550 8519	Bremsachse	Braking axle	GS12008 55.72.448.000	141 .. 142
16	550 8520	Laufachse	Running axle	GS7008 55.67.001.014	143
16	550 8872	Rad 8/221/275	Wheel 8/221/575	Trelleborg 550/60-22.5 12PR/RE	144
16	550 8873	Rad 8/221/275	Wheel 8/221/575	Trelleborg 550/60-22.5 12PR/LI	145
16	550 8874	Rad 8/221/275	Wheel 8/221/575	12,5/80-18 12PR AW	146
16	550 8884	Rad 8/221/275	Wheel 8/221/575	Alliance 700/50-22,5 12PR ETO	147
16	550 8885	Rad 8/221/275	Wheel 8/221/575	Alliance 700/50-22,5 12PR ETO	148
16	650 8518	Laufachse	Running axle	140x2530 8/220/275	149
16	650 8534	Fahrwerk	Trailer	Smaragd 9 KA B -12.01	150 .. 151
16	650 8537	Fahrwerk	Trailer	Smaragd 9 KA B 01.02-	152 .. 153
16	677 6030	Druckluftbremsanlage	Compressed-air brake	Smaragd 9 KA B	154 .. 156
17	661 8510	Hydraulisches Aushubgestänge	Hydraulic lift linkage	D50x200 L2 Z2	157 .. 158
18	582 1248	Achse zum Spuranreißer	Axle for track marker	D30x595 668A	159
18	582 1276	Zusatzteile Verriegelung	Additional parts locking dev.	Spuranreißer Z600	160
18	682 1253	Spuranreißer	Track marker	Solitair FW450/Z600 D380	161 .. 162
18	682 1290	Konsole für Spuranreißer	Bracket for track marker	Smaragd 9/6M RE	163
18	682 1291	Konsole für Spuranreißer	Bracket for track marker	Smaragd 9/6M LI	164
19	661 8366	Kupplungsteil	Kupplungsteil	FK 150x150 (Solitair 9KA)	165
19	661 8368	Kupplungsteil	Kupplungsteil	FK 140x140 (Solitair 9KA)	166
19	661 8369	Kupplungsteil	Kupplungsteil	FK 150x150x120 (Solitair 9KA)	167
20	617 8083	Träger 1Paar U-Form f.Striegel	Carrier, 1 pair U-shape	120x2095-80-60 SM9KAÜ	168
20	617 8110	Träger 1Paar für Striegel	Carrier, 1 pair for harrow	120x1795-80x20 SM-9K	169
20	617 8111	Träger 1Paar für Striegel	Carrier, 1 pair for harrow	120x2095-80x20 Smaragd 9 KÜ	170
20	622 6386	Federstriegel 1Paar	Levelling type harrow	STR80-600	171

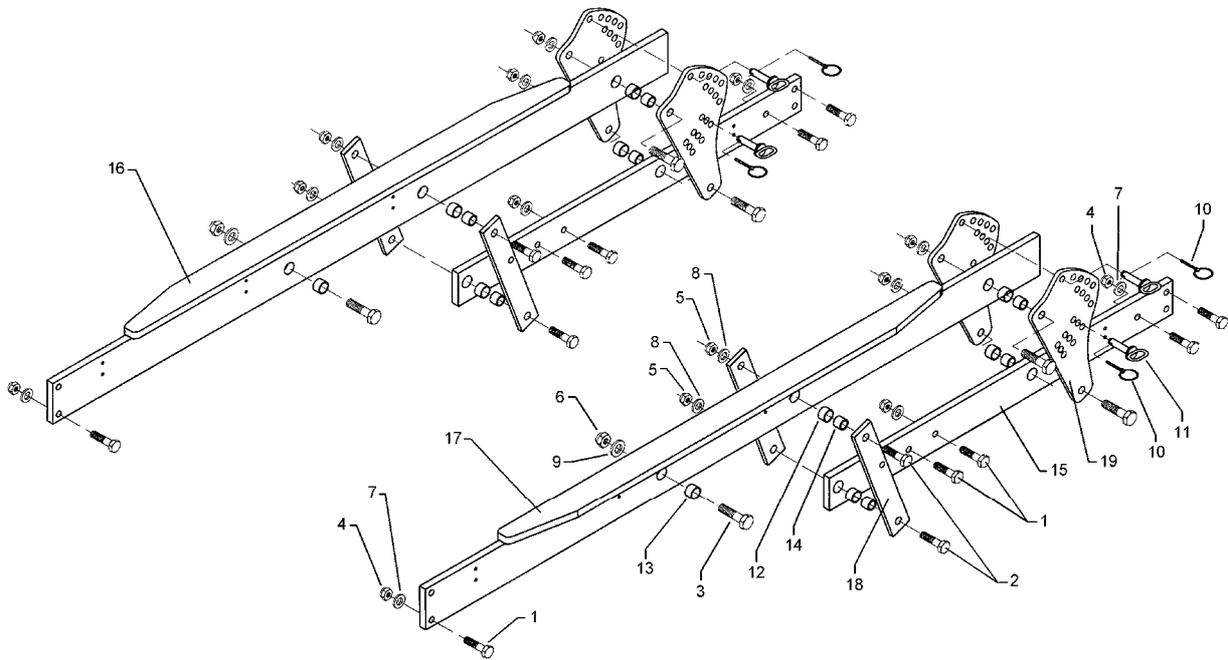

11.04

Pos.	Art.-Nr.	Stk.	Artikeltext / Description		Abmessung
1	301 3870	8	Sechskantschraube spz.	Bolt	M16x65-10.9
2	301 4602	8	Sechskantschraube spz.	Bolt	M20x75-8.8
3	301 5392	2	Sechskantschraube spz.	Bolt	M24x85-8.8
4	303 0935	8	Sicherungsmutter	Selflocking nut	DIN985-NM16-8 Zn
5	303 0936	8	Sicherungsmutter	Selflocking nut	DIN985-NM20-8 Zn
6	303 0937	2	Sicherungsmutter	Selflocking nut	DIN985-NM24-8 Zn
7	305 6155	8	Scheibe	Washer	D30/17x6 St-37
8	305 6164	8	Scheibe	Washer	D35/20,5x5
9	305 6274	2	Scheibe	Washer	D50/25x8
10	311 9565	4	Klappstift	Securing pin	4,5mm
11	313 8140	4	Bolzen mit Griff	Pin with grip	GB D16x50,8/70 Zn
12	317 3352	8	Einspannbuchse mit Preßsitz	Expansion bush	EG28/32x20
13	317 3407	2	Einspannbuchse	Expansion bush	EG24/32x20-DIN1498
14	317 6657	8	Buchse	Bush	D20/28x22
15	417 8098	2	Träger	Carrier	100x20x1162 2xD32 6xD16 4xD7
16	417 8078	1	Träger T-Profil	Carrier	120x20x2095-80x20x1500 RE
17	417 8079	1	Träger T-Profil	Carrier	120x20x2095-80x20x1500 LI
18	417 8110	4	Lenker	Link	60x12x382
19	417 8111	4	Verstellplatte	Adjuster plate	12x406,5x209

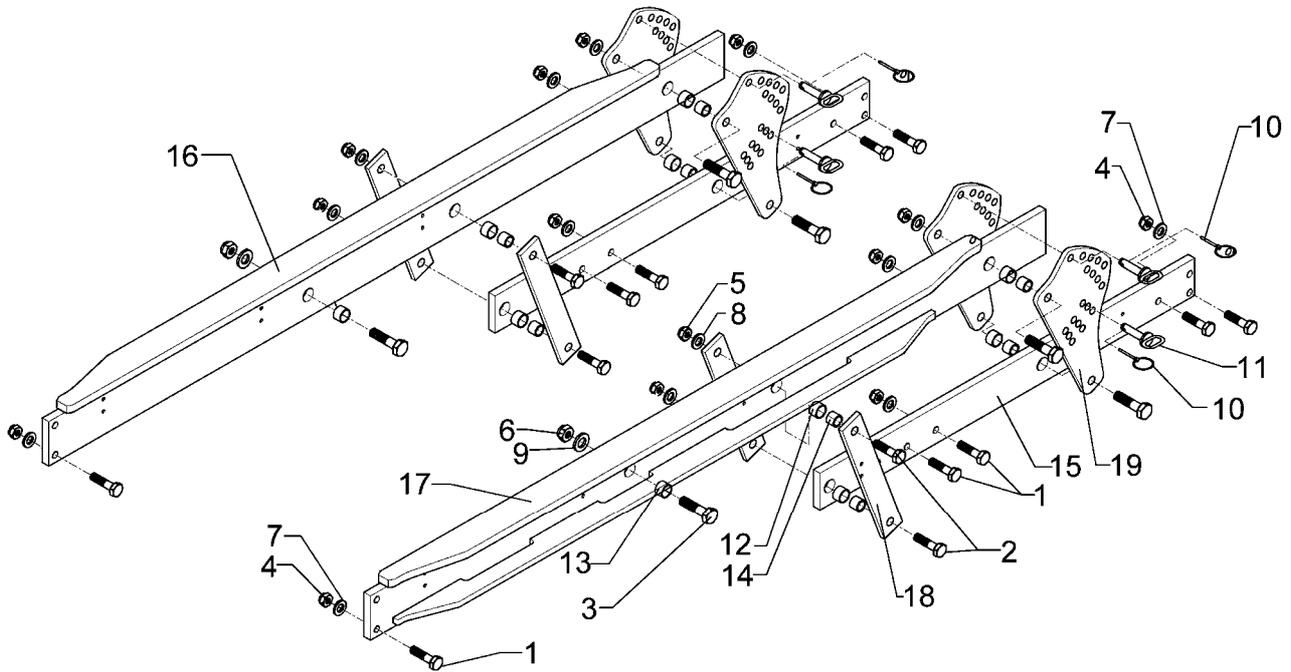

11.04

Pos.	Art.-Nr.	Stk.	Artikeltext / Description		Abmessung
1	301 3870	8	Sechskantschraube spz.	Bolt	M16x65-10.9
2	301 4602	8	Sechskantschraube spz.	Bolt	M20x75-8.8
3	301 5392	2	Sechskantschraube spz.	Bolt	M24x85-8.8
4	303 0935	8	Sicherungsmutter	Selflocking nut	DIN985-NM16-8 Zn
5	303 0936	8	Sicherungsmutter	Selflocking nut	DIN985-NM20-8 Zn
6	303 0937	2	Sicherungsmutter	Selflocking nut	DIN985-NM24-8 Zn
7	305 6155	8	Scheibe	Washer	D30/17x6 St-37
8	305 6164	8	Scheibe	Washer	D35/20,5x5
9	305 6274	2	Scheibe	Washer	D50/25x8
10	311 9565	4	Klappstift	Securing pin	4,5mm
11	313 8140	4	Bolzen mit Griff	Pin with grip	GB D16x50,8/70 Zn
12	317 3352	8	Einspannbuchse mit Preßsitz	Expansion bush	EG28/32x20
13	317 3407	2	Einspannbuchse	Expansion bush	EG24/32x20-DIN1498
14	317 6657	8	Buchse	Bush	D20/28x22
15	417 8098	2	Träger	Carrier	100x20x1162 2xD32 6xD16 4xD7
16	417 8082	1	Träger	Carrier	120x20x2095-80x20-60x15 RE
17	417 8083	1	Träger	Carrier	120x20x2095-80x20-60x15 LI
18	417 8110	4	Lenker	Link	60x12x382
19	417 8111	4	Verstellplatte	Adjuster plate	12x406,5x209

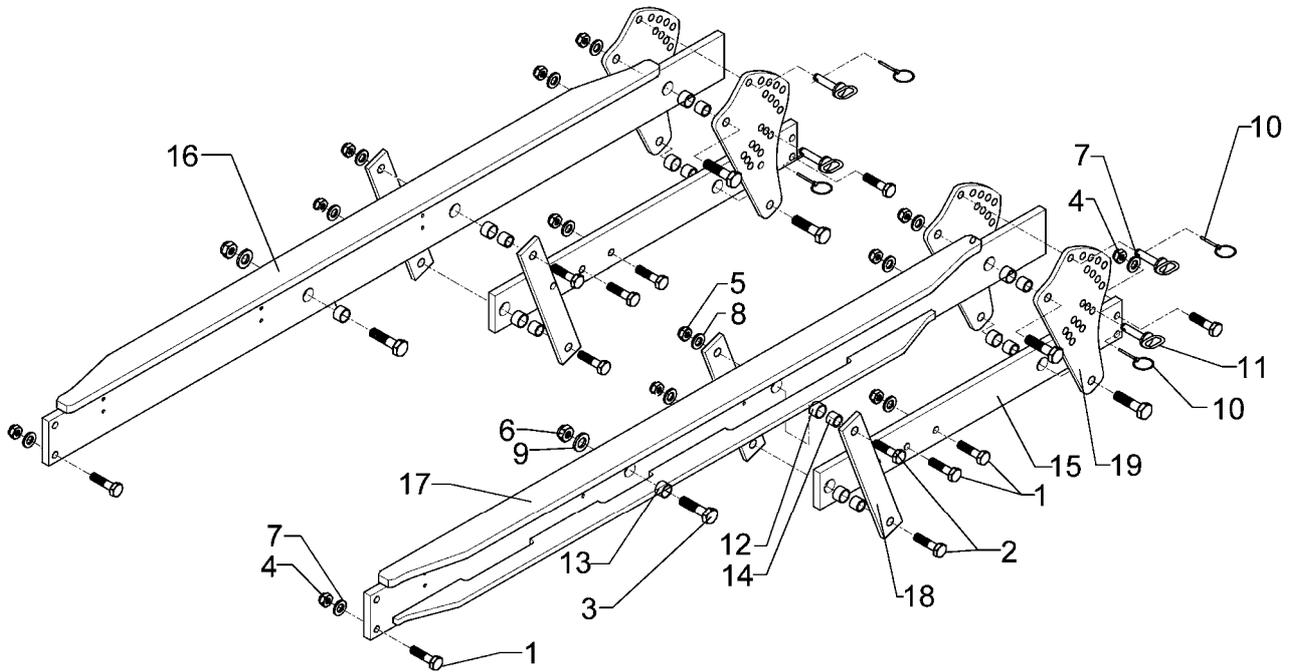

11.04

Pos.	Art.-Nr.	Stk.	Artikeltext / Description		Abmessung
1	301 3870	8	Sechskantschraube spz.	Bolt	M16x65-10.9
2	301 4602	8	Sechskantschraube spz.	Bolt	M20x75-8.8
3	301 5392	2	Sechskantschraube spz.	Bolt	M24x85-8.8
4	303 0935	8	Sicherungsmutter	Selflocking nut	DIN985-NM16-8 Zn
5	303 0936	8	Sicherungsmutter	Selflocking nut	DIN985-NM20-8 Zn
6	303 0937	2	Sicherungsmutter	Selflocking nut	DIN985-NM24-8 Zn
7	305 6155	8	Scheibe	Washer	D30/17x6 St-37
8	305 6164	8	Scheibe	Washer	D35/20,5x5
9	305 6274	2	Scheibe	Washer	D50/25x8
10	311 9565	4	Klappstift	Securing pin	4,5mm
11	313 8140	4	Bolzen mit Griff	Pin with grip	GB D16x50,8/70 Zn
12	317 3352	8	Einspannbuchse mit Preßsitz	Expansion bush	EG28/32x20
13	317 3407	2	Einspannbuchse	Expansion bush	EG24/32x20-DIN1498
14	317 6657	8	Buchse	Bush	D20/28x22
15	417 8127	2	Träger	Carrier	100x20x937 RSW600
16	417 8082	1	Träger	Carrier	120x20x2095-80x20-60x15 RE
17	417 8083	1	Träger	Carrier	120x20x2095-80x20-60x15 LI
18	417 8110	4	Lenker	Link	60x12x382
19	417 8111	4	Verstellplatte	Adjuster plate	12x406,5x209

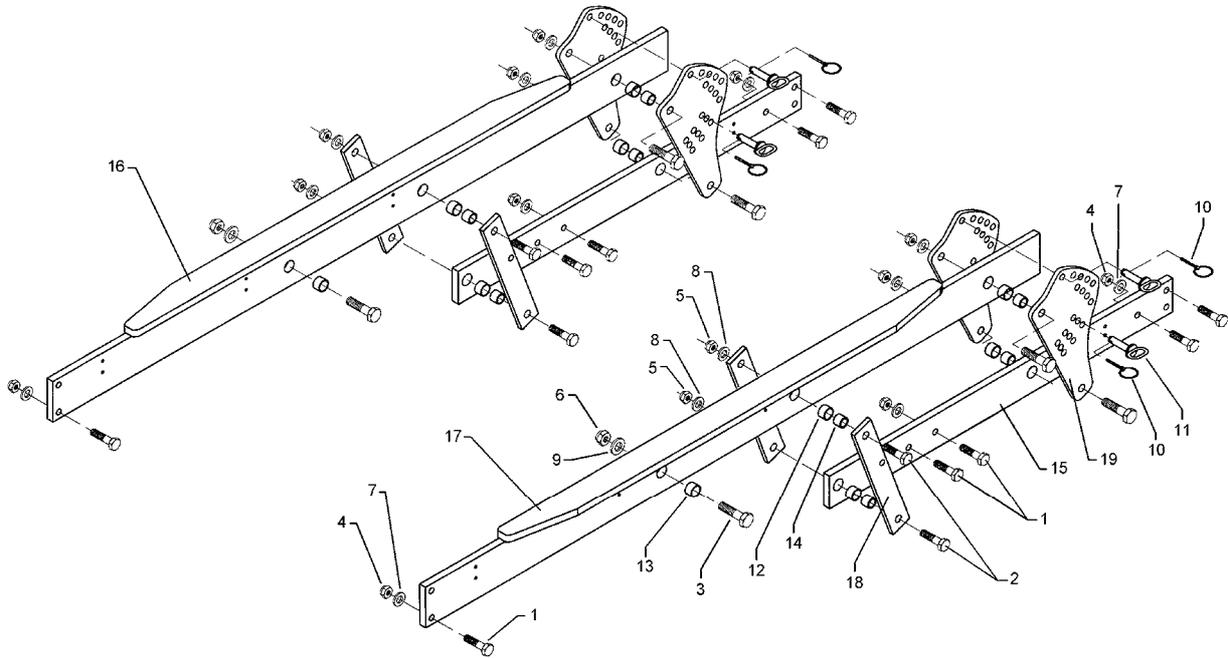

11.04

Pos.	Art.-Nr.	Stk.	Artikeltext / Description		Abmessung
1	301 3870	8	Sechskantschraube spz.	Bolt	M16x65-10.9
2	301 4602	8	Sechskantschraube spz.	Bolt	M20x75-8.8
3	301 5392	2	Sechskantschraube spz.	Bolt	M24x85-8.8
4	303 0935	8	Sicherungsmutter	Selflocking nut	DIN985-NM16-8 Zn
5	303 0936	8	Sicherungsmutter	Selflocking nut	DIN985-NM20-8 Zn
6	303 0937	2	Sicherungsmutter	Selflocking nut	DIN985-NM24-8 Zn
7	305 6155	8	Scheibe	Washer	D30/17x6 St-37
8	305 6164	8	Scheibe	Washer	D35/20,5x5
9	305 6274	2	Scheibe	Washer	D50/25x8
10	311 9565	4	Klappstift	Securing pin	4,5mm
11	313 8140	4	Bolzen mit Griff	Pin with grip	GB D16x50,8/70 Zn
12	317 3352	8	Einspannbuchse mit Preßsitz	Expansion bush	EG28/32x20
13	317 3407	2	Einspannbuchse	Expansion bush	EG24/32x20-DIN1498
14	317 6657	8	Buchse	Bush	D20/28x22
15	417 8098	2	Träger	Carrier	100x20x1162 2xD32 6xD16 4xD7
16	417 8086	1	Träger T-Profil	Carrier	120x20x1795-80x20x1200 RE
17	417 8087	1	Träger T-Profil	Carrier	120x20x1795-80x20x1200 LI
18	417 8110	4	Lenker	Link	60x12x382
19	417 8111	4	Verstellplatte	Adjuster plate	12x406,5x209

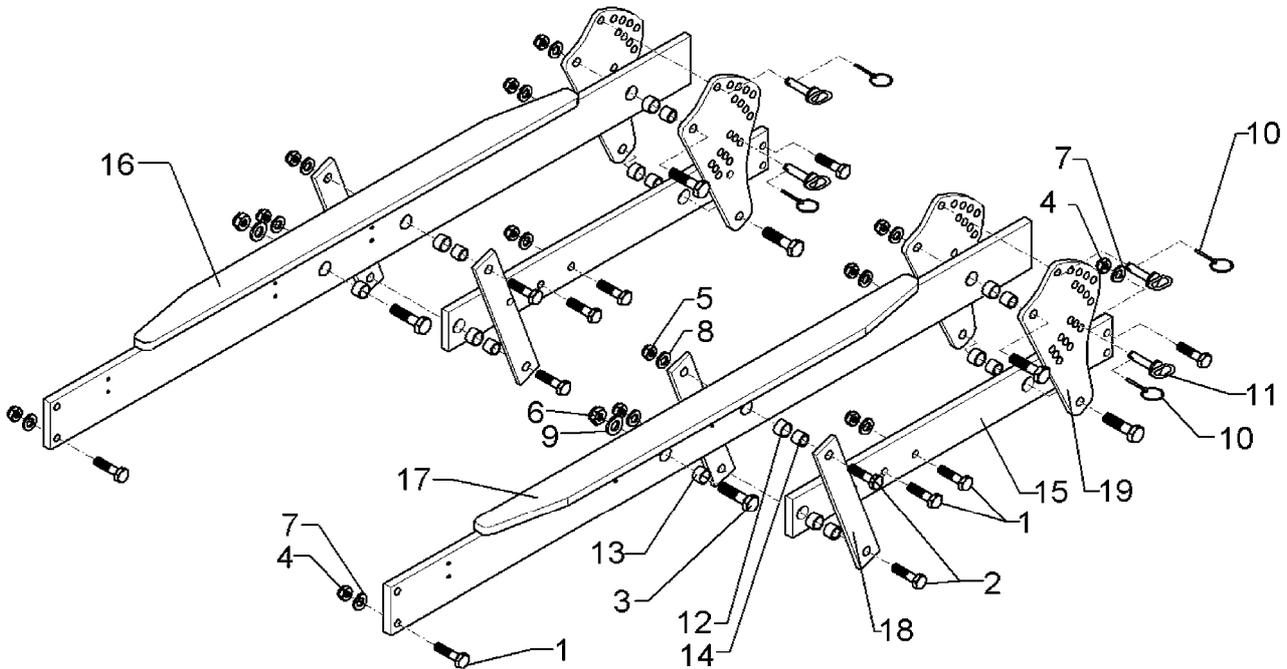

11.04

Pos.	Art.-Nr.	Stk.	Artikeltext / Description		Abmessung
1	301 3870	8	Sechskantschraube spz.	Bolt	M16x65-10.9
2	301 4602	8	Sechskantschraube spz.	Bolt	M20x75-8.8
3	301 5392	2	Sechskantschraube spz.	Bolt	M24x85-8.8
4	303 0935	8	Sicherungsmutter	Selflocking nut	DIN985-NM16-8 Zn
5	303 0936	8	Sicherungsmutter	Selflocking nut	DIN985-NM20-8 Zn
6	303 0937	2	Sicherungsmutter	Selflocking nut	DIN985-NM24-8 Zn
7	305 6155	8	Scheibe	Washer	D30/17x6 St-37
8	305 6164	8	Scheibe	Washer	D35/20,5x5
9	305 6274	2	Scheibe	Washer	D50/25x8
10	311 9565	4	Klappstift	Securing pin	4,5mm
11	313 8140	4	Bolzen mit Griff	Pin with grip	GB D16x50,8/70 Zn
12	317 3352	8	Einspannbuchse mit Preßsitz	Expansion bush	EG28/32x20
13	317 3407	2	Einspannbuchse	Expansion bush	EG24/32x20-DIN1498
14	317 6657	8	Buchse	Bush	D20/28x22
15	417 8127	2	Träger	Carrier	100x20x937 RSW600
16	417 8086	1	Träger T-Profil	Carrier	120x20x1795-80x20x1200 RE
17	417 8087	1	Träger T-Profil	Carrier	120x20x1795-80x20x1200 LI
18	417 8110	4	Lenker	Link	60x12x382
19	417 8111	4	Verstellplatte	Adjuster plate	12x406,5x209

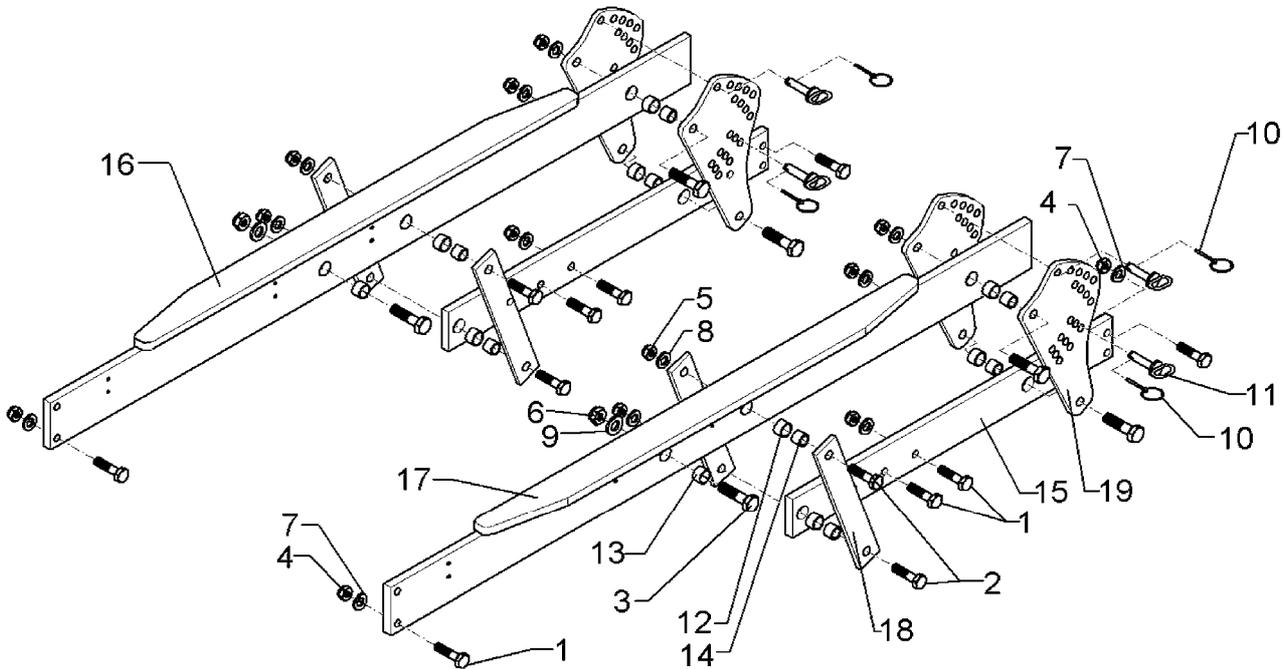

11.04

Pos.	Art.-Nr.	Stk.	Artikeltext / Description		Abmessung
1	301 3870	8	Sechskantschraube spz.	Bolt	M16x65-10.9
2	301 4602	8	Sechskantschraube spz.	Bolt	M20x75-8.8
3	301 5392	2	Sechskantschraube spz.	Bolt	M24x85-8.8
4	303 0935	8	Sicherungsmutter	Selflocking nut	DIN985-NM16-8 Zn
5	303 0936	8	Sicherungsmutter	Selflocking nut	DIN985-NM20-8 Zn
6	303 0937	2	Sicherungsmutter	Selflocking nut	DIN985-NM24-8 Zn
7	305 6155	8	Scheibe	Washer	D30/17x6 St-37
8	305 6164	8	Scheibe	Washer	D35/20,5x5
9	305 6274	2	Scheibe	Washer	D50/25x8
10	311 9565	4	Klappstift	Securing pin	4,5mm
11	313 8140	4	Bolzen mit Griff	Pin with grip	GB D16x50,8/70 Zn
12	317 3352	8	Einspannbuchse mit Preßsitz	Expansion bush	EG28/32x20
13	317 3407	2	Einspannbuchse	Expansion bush	EG24/32x20-DIN1498
14	317 6657	8	Buchse	Bush	D20/28x22
15	417 8127	2	Träger	Carrier	100x20x937 RSW600
16	417 8078	1	Träger T-Profil	Carrier	120x20x2095-80x20x1500 RE
17	417 8079	1	Träger T-Profil	Carrier	120x20x2095-80x20x1500 LI
18	417 8110	4	Lenker	Link	60x12x382
19	417 8111	4	Verstellplatte	Adjuster plate	12x406,5x209

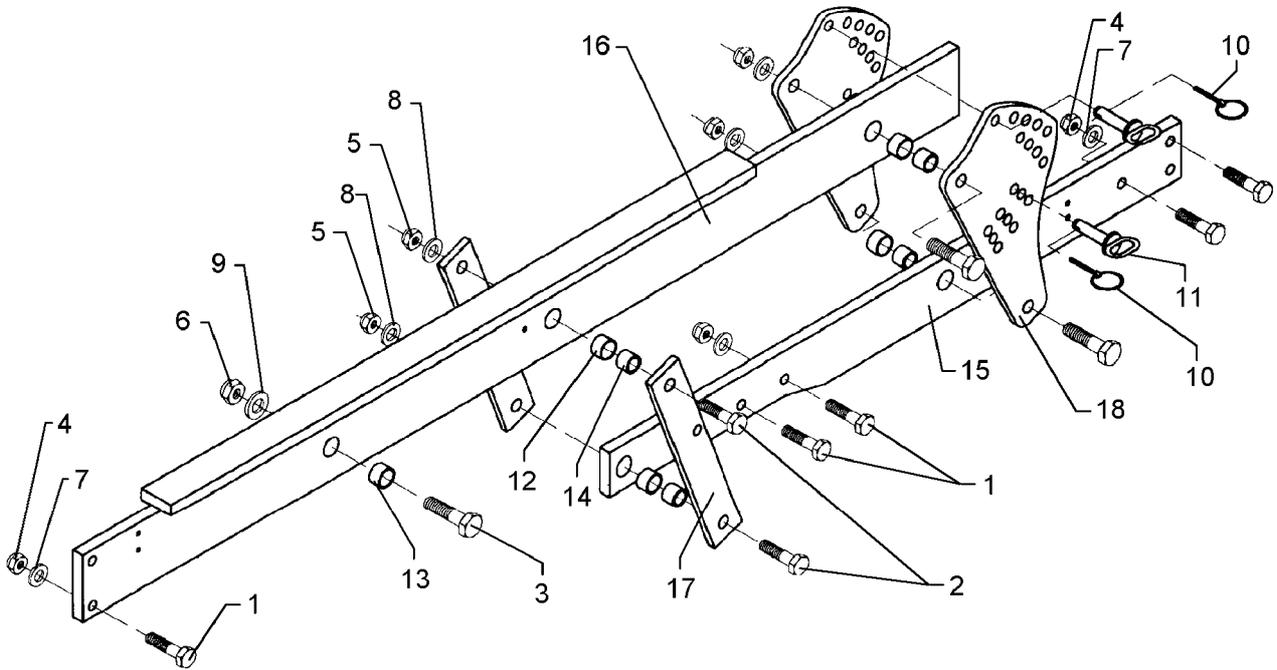

11.04

Pos.	Art.-Nr.	Stk.	Artikeltext / Description		Abmessung
1	301 3870	4	Sechskantschraube spz.	Bolt	M16x65-10.9
2	301 4602	4	Sechskantschraube spz.	Bolt	M20x75-8.8
3	301 5392	1	Sechskantschraube spz.	Bolt	M24x85-8.8
4	303 0935	4	Sicherungsmutter	Selflocking nut	DIN985-NM16-8 Zn
5	303 0936	4	Sicherungsmutter	Selflocking nut	DIN985-NM20-8 Zn
6	303 0937	1	Sicherungsmutter	Selflocking nut	DIN985-NM24-8 Zn
7	305 6155	4	Scheibe	Washer	D30/17x6 St-37
8	305 6164	4	Scheibe	Washer	D35/20,5x5
9	305 6274	1	Scheibe	Washer	D50/25x8
10	311 9565	2	Klappstift	Securing pin	4,5mm
11	313 8140	2	Bolzen mit Griff	Pin with grip	GB D16x50,8/70 Zn
12	317 3352	4	Einspannbuchse mit Preßsitz	Expansion bush	EG28/32x20
13	317 3407	1	Einspannbuchse	Expansion bush	EG24/32x20-DIN1498
14	317 6657	4	Buchse	Bush	D20/28x22
15	417 8098	1	Träger	Carrier	100x20x1162 2xD32 6xD16 4xD7
16	417 8122	1	Träger T-Profil	Carrier	120x20x1795-60x20x1200
17	417 8110	2	Lenker	Link	60x12x382
18	417 8111	2	Verstellplatte	Adjuster plate	12x406,5x209

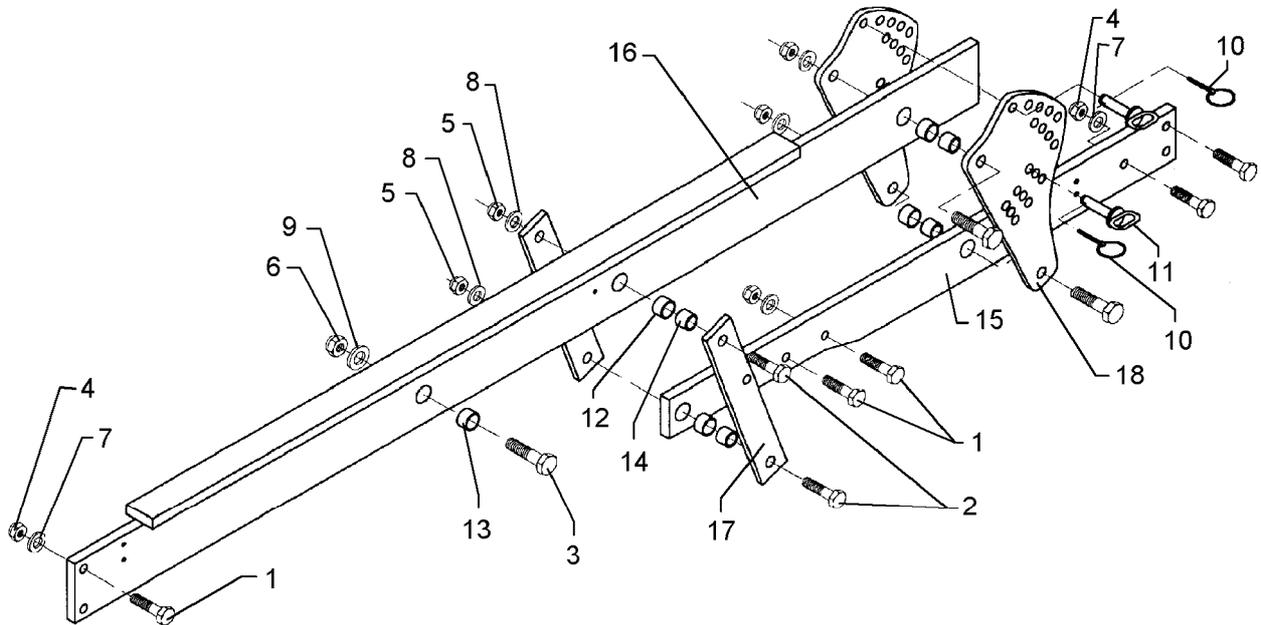

11.04

Pos.	Art.-Nr.	Stk.	Artikeltext / Description		Abmessung
1	301 3870	7	Sechskantschraube spz.	Bolt	M16x65-10.9
2	301 4602	4	Sechskantschraube spz.	Bolt	M20x75-8.8
3	301 5392	1	Sechskantschraube spz.	Bolt	M24x85-8.8
4	303 0935	7	Sicherungsmutter	Selflocking nut	DIN985-NM16-8 Zn
5	303 0936	4	Sicherungsmutter	Selflocking nut	DIN985-NM20-8 Zn
6	303 0937	1	Sicherungsmutter	Selflocking nut	DIN985-NM24-8 Zn
7	305 6155	7	Scheibe	Washer	D30/17x6 St-37
8	305 6164	4	Scheibe	Washer	D35/20,5x5
9	305 6274	1	Scheibe	Washer	D50/25x8
10	311 9565	2	Klappstift	Securing pin	4,5mm
11	313 8140	2	Bolzen mit Griff	Pin with grip	GB D16x50,8/70 Zn
12	317 3352	4	Einspannbuchse mit Preßsitz	Expansion bush	EG28/32x20
13	317 3407	1	Einspannbuchse	Expansion bush	EG24/32x20-DIN1498
14	317 6657	4	Buchse	Bush	D20/28x22
15	417 8098	1	Träger	Carrier	100x20x1162 2xD32 6xD16 4xD7
16	417 8123	1	Träger T-Profil	Carrier	120x20x2095-60x20x1500
17	417 8110	2	Lenker	Link	60x12x382
18	417 8111	2	Verstellplatte	Adjuster plate	12x406,5x209

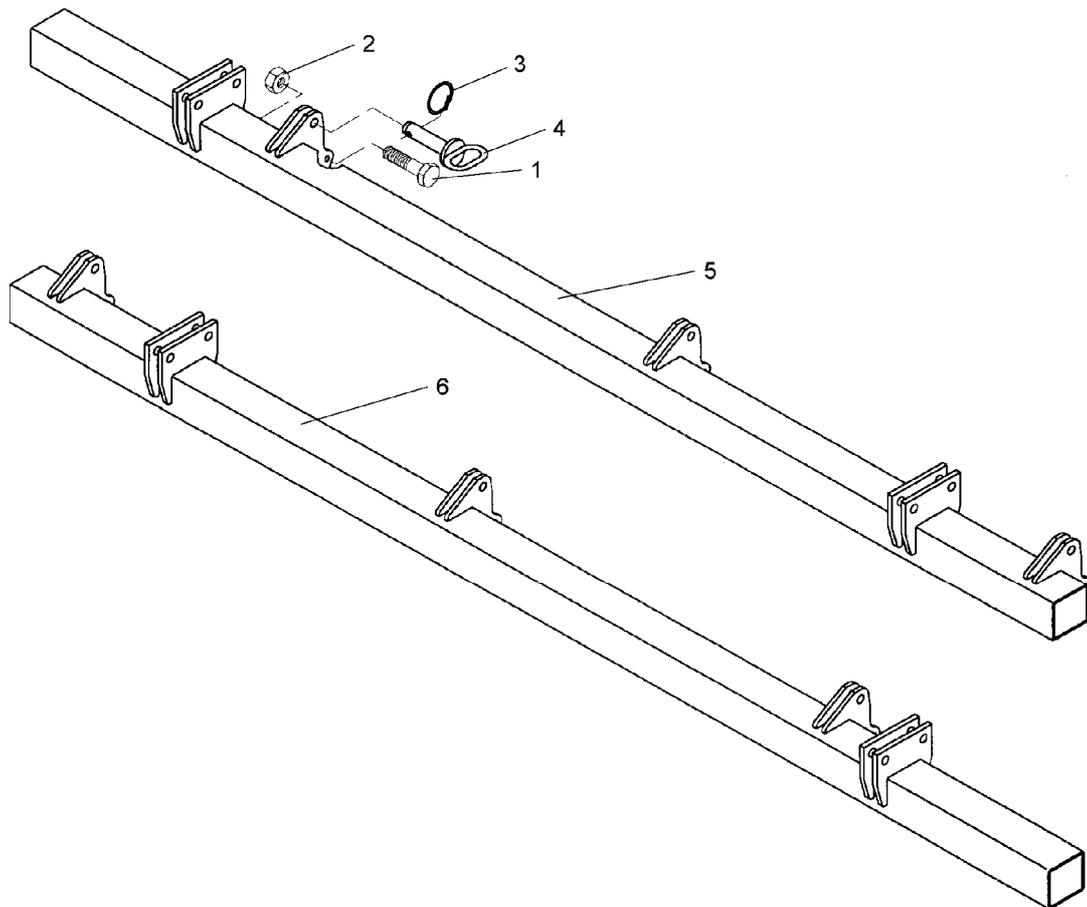

11.04

Pos.	Art.-Nr.	Stk.	Artikeltext / Description		Abmessung
1	301 3240	6	Sechskantschraube spz.	Bolt	M10x45-8.8
2	303 0933	6	Sicherungsmutter	Selflocking nut	DIN985-NM10-8 Zn
3	305 8551	6	Federsicherung	Securing clip	41x3
4	313 1530	6	Bolzen mit Griff	Pin with grip	GB D15x41,8/60
5	417 8162	1	Tragrohr für Hohl-scheiben	Frame for hollow discs	80x80x2470 RE Smaragd 9/600
6	417 8163	1	Tragrohr für Hohl-scheiben	Frame for hollow discs	80x80x2470 LI Smaragd 9/600

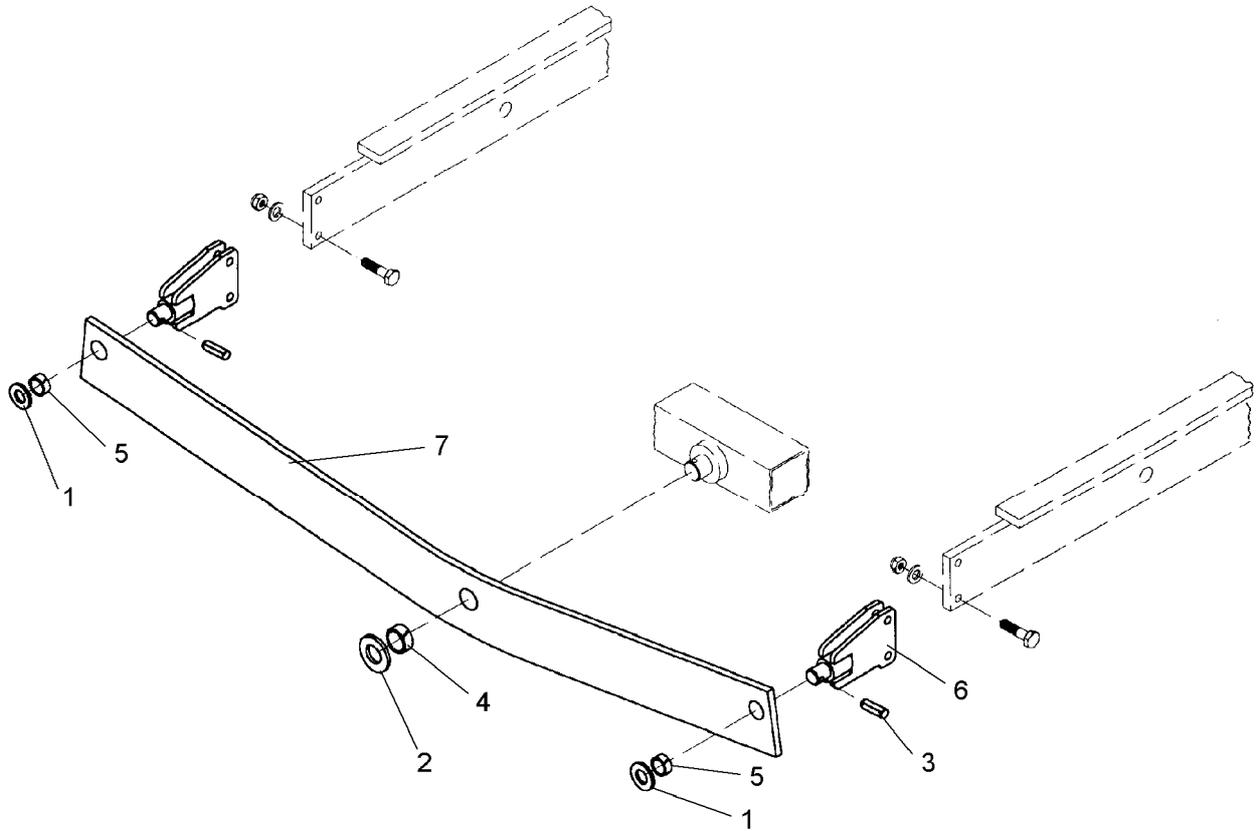

11.04

Pos.	Art.-Nr.	Stk.	Artikeltext / Description	Abmessung	
1	305 2050	4	Paßscheibe	Shim	30x42x1,0 DIN988
2	305 2250	1	Stützscheibe	Supporting washer	S 40x50x2,5 DIN988
3	309 6174	3	Spannhülse	Expansion bush	10x70-DIN1481
4	317 2008	1	Einspannbuchse mit Preßsitz	Expansion bush	EG40/44x16
5	317 3351	2	Einspannbuchse	Expansion bush	EG30/38x16-DIN1498
6	417 8125	2	Zapfen mit Platte	Plate with pivot	D30-160-2xD16 Smaragd 9
7	417 8131	1	Waagebalken	Balance bar	140x15x1795 SM-9/600

D - Ersatzteilzeichnung noch nicht verfügbar!

GB - Spare parts drawing is not available yet!

F - Le dessin des pièces n'est pas encore disponible!

NL - Onderdelentekeningen zijn not niet aanwezig!

E - El dibujo de las piezas no está disponible!

DK - Reservedelstegning endnu ikke til rådighed!

11.04

Pos.	Art.-Nr.	Stk.	Artikeltext / Description		Abmessung
1	301 3240	5	Sechskantschraube spz.	Bolt	M10x45-8.8
2	301 3399	10	Sechskantschraube spz.	Bolt	M12x65-10.9
3	303 0933	5	Sicherungsmutter	Selflocking nut	DIN985-NM10-8 Zn
4	303 0970	5	Sechskantmutter	Nut	M10 DIN934-8
5	303 1013	10	Sechskantmutter	Nut	M12 DIN934-8 Zn

D - Ersatzteilzeichnung noch nicht verfügbar!

GB - Spare parts drawing is not available yet!

F - Le dessin des pièces n'est pas encore disponible!

NL - Onderdelentekeningen zijn not niet aanwezig!

E - El dibujo de las piezas no está disponible!

DK - Reservedelstegning endnu ikke til rådighed!

11.04

Pos.	Art.-Nr.	Stk.	Artikeltext / Description		Abmessung
1	301 3240	5	Sechskantschraube spz.	Bolt	M10x45-8.8
2	301 4600	5	Sechskantschraube DIN931-A	Bolt	M20x70x28-8.8
3	303 0933	5	Sicherungsmutter	Selflocking nut	DIN985-NM10-8 Zn
4	303 0936	5	Sicherungsmutter	Selflocking nut	DIN985-NM20-8 Zn
5	303 0970	5	Sechskantmutter	Nut	M10 DIN934-8

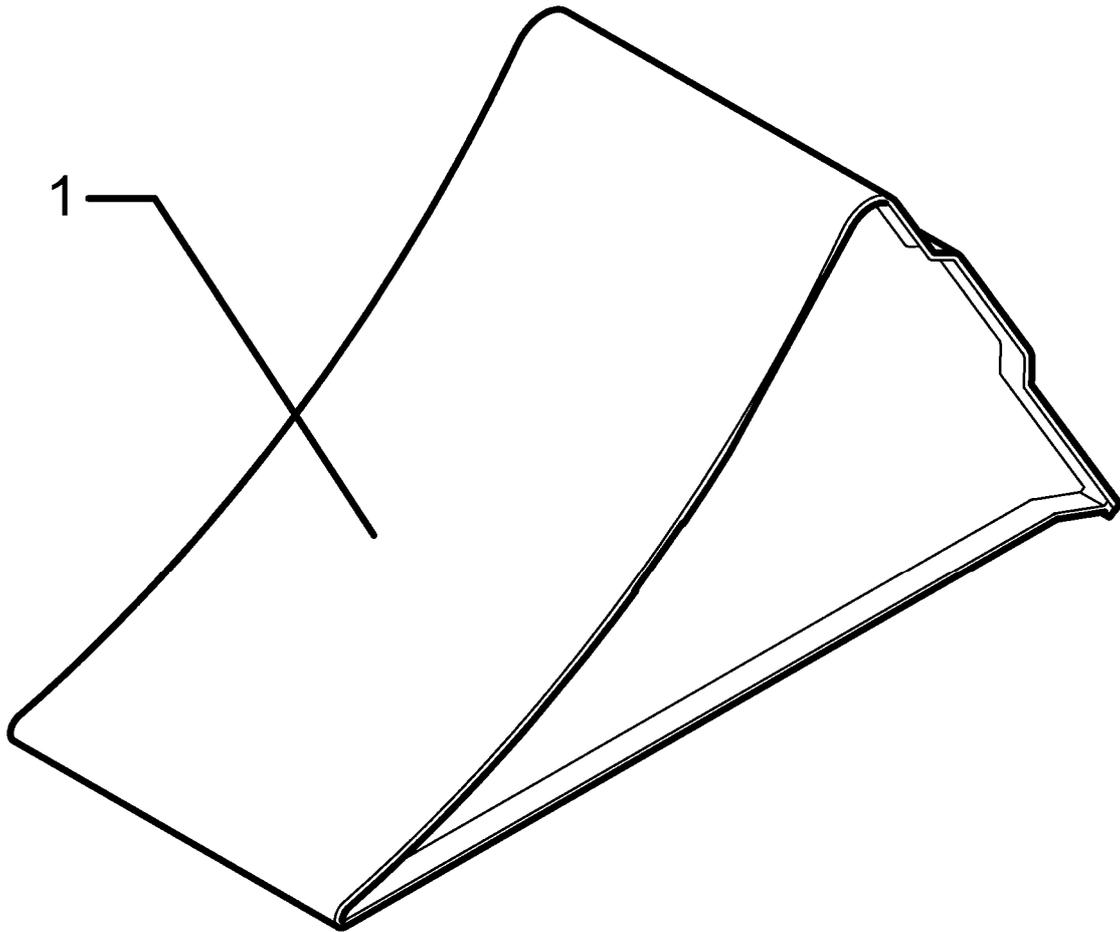

11.04

Pos.	Art.-Nr.	Stk.	Artikeltext / Description	Abmessung	
1	321 9942	2	Unterlegkeil	Chock	NG53 DIN76051 Zn

D - Ersatzteilzeichnung noch nicht verfügbar!

GB - Spare parts drawing is not available yet!

F - Le dessin des pièces n'est pas encore disponible!

NL - Onderdelentekeningen zijn not niet aanwezig!

E - El dibujo de las piezas no está disponible!

DK - Reservedelstegning endnu ikke til rådighed!

11.04

Pos.	Art.-Nr.	Stk.	Artikeltext / Description		Abmessung
1	301 3240	5	Sechskantschraube spz.	Bolt	M10x45-8.8
2	301 3391	10	Sechskantschraube spz.	Bolt	M12x60-10.9
3	303 0933	5	Sicherungsmutter	Selflocking nut	DIN985-NM10-8 Zn
4	303 1013	10	Sechskantmutter	Nut	M12 DIN934-8 Zn

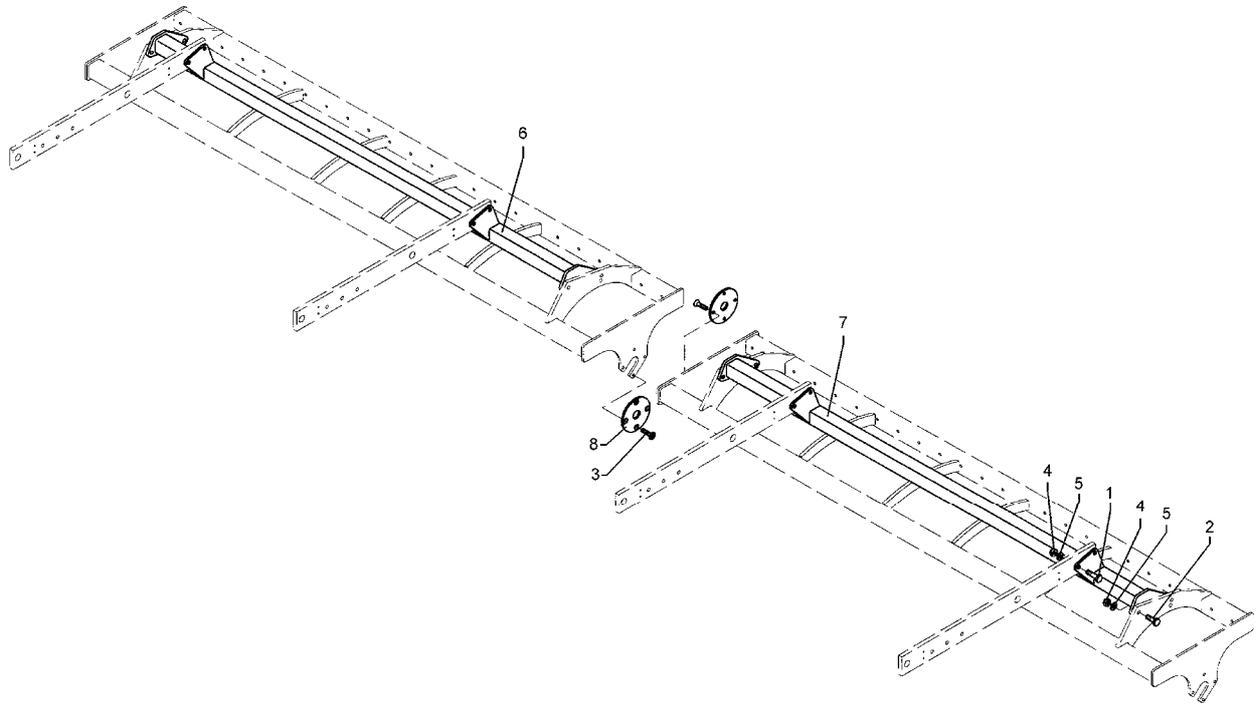

11.04

Pos.	Art.-Nr.	Stk.	Artikeltext / Description		Abmessung
1	301 5360	8	Sechskantschraube spz.	Bolt	M16x70-12.9
2	301 5388	8	Sechskantschraube spz.	Bolt	M16x45-8.8
3	301 6131	8	Senkschraube DIN7991-A	Countersunk bolt	M12x45-10.9
4	303 0935	16	Sicherungsmutter	Selflocking nut	DIN985-NM16-8 Zn
5	305 6155	8	Scheibe	Washer	D30/17x6 St-37
6	417 8188	1	Adapter für Zahnpackerwalze	Adapter for packer roller	RE SM9/600K
7	417 8189	1	Adapter für Zahnpackerwalze	Adapter for packer roller	LI SM9/600K
8	422 2920	2	Platte für Zahnpackerwalze	Plate for packer roller	Smaragd 9

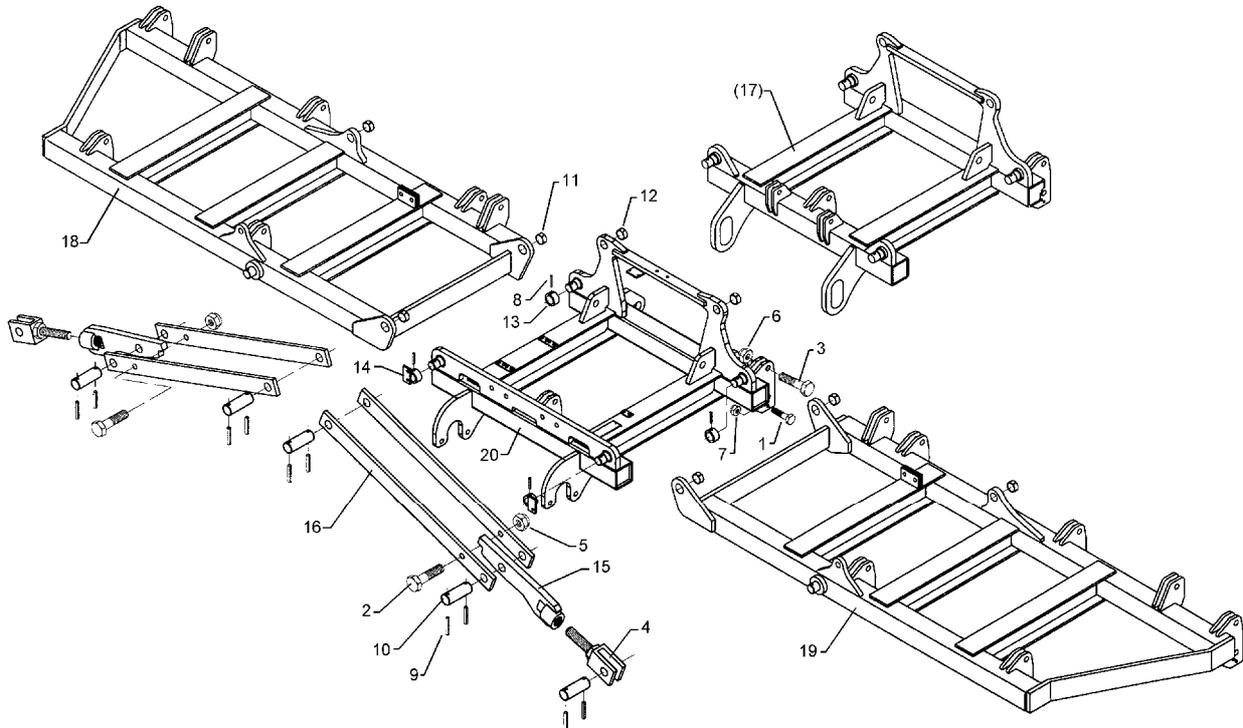

11.04

Pos.	Art.-Nr.	Stk.	Artikeltext / Description		Abmessung
1	301 3399	13	Sechskantschraube spz.	Bolt	M12x65-10.9
2	301 5360	2	Sechskantschraube spz.	Bolt	M16x70-12.9
3	301 5392	13	Sechskantschraube spz.	Bolt	M24x85-8.8
4	302 8962	2	Gabelstück	Forkpiece	M30x90-22-D25
5	303 0935	2	Sicherungsmutter	Selflocking nut	DIN985-NM16-8 Zn
6	303 0937	13	Sicherungsmutter	Selflocking nut	DIN985-NM24-8 Zn
7	303 0972	13	Sechskantmutter	Nut	M12 DIN934-8
8	309 6211	4	Spannhülse	Expansion bush	12x60-DIN1481
9	309 6073	12	Spannhülse	Expansion bush	8x50-DIN1481
10	313 7770	6	Bolzen	Pin	BB D25x48/78 Zn
11	317 2005	4	Einspannbuchse mit Preßsitz	Expansion bush	EG40/44x20
12	317 3417	4	Einspannbuchse mit Preßsitz	Expansion bush	EG30/38x25
13	317 8641	2	Stelling	Adjusting ring	D54/38x32-D12
14	317 8642	2	Stelling mit Lasche	Adjusting ring with lashing	D55/38x32 70x40 2xD11
15	417 8140	2	Gelenkstück	Joint	20x100x315-M30
16	417 8143	4	Zugstange	Drawrod	50x12x992
17	417 8211	1	Mittelteil	Center section	Smaragd 9/600-K D68
18	417 8216	1	Seitenteil	Lateral part	Smaragd 9/600 RE
19	417 8217	1	Seitenteil	Lateral part	Smaragd 9/600 LI
20	417 8229	1	Mittelteil	Center section	Smaragd 9/600-K D20

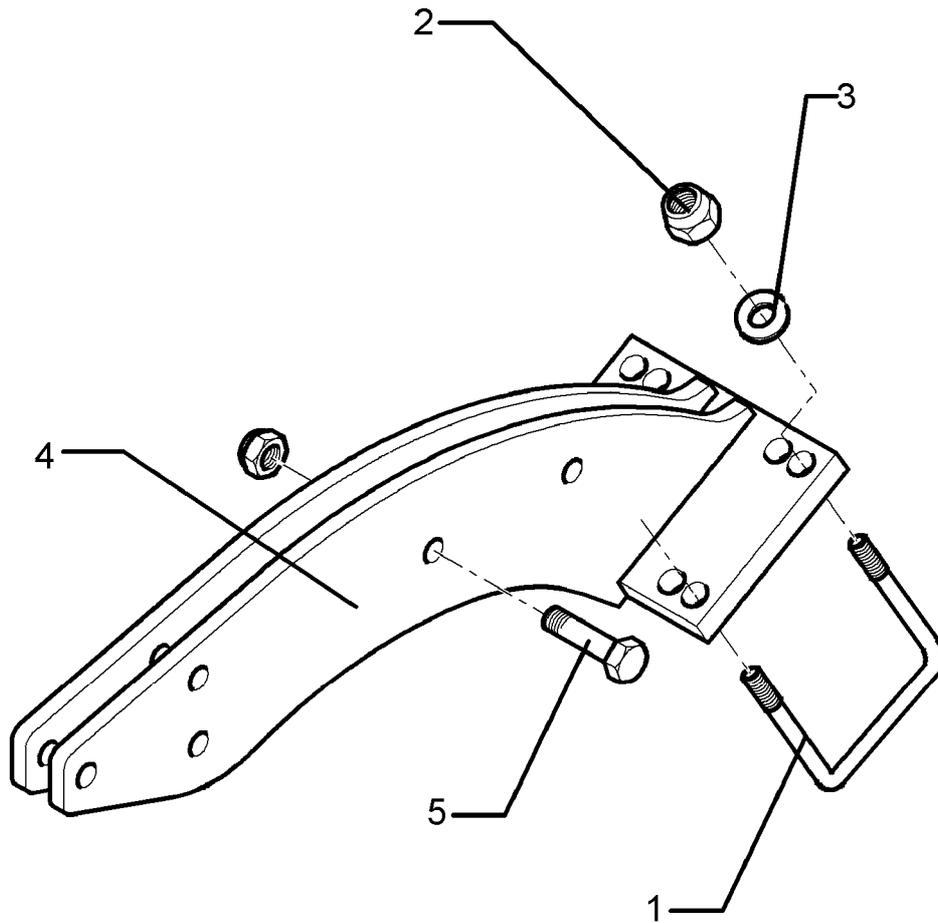

11.04

Pos.	Art.-Nr.	Stk.	Artikeltext / Description		Abmessung
1	301 7797	2	Bügelsschraube	U-bolt	M16/90/135 (381)
2	303 0935	5	Sicherungsmutter	Selflocking nut	DIN985-NM16-8 Zn
3	305 6143	4	Scheibe	Washer	B17/30x3 DIN125
4	422 0184	1	Halter	Holder	140x177x20-90 GRW D590
5	301 3870	1	Sechskantschraube spz.	Bolt	M16x65-10.9

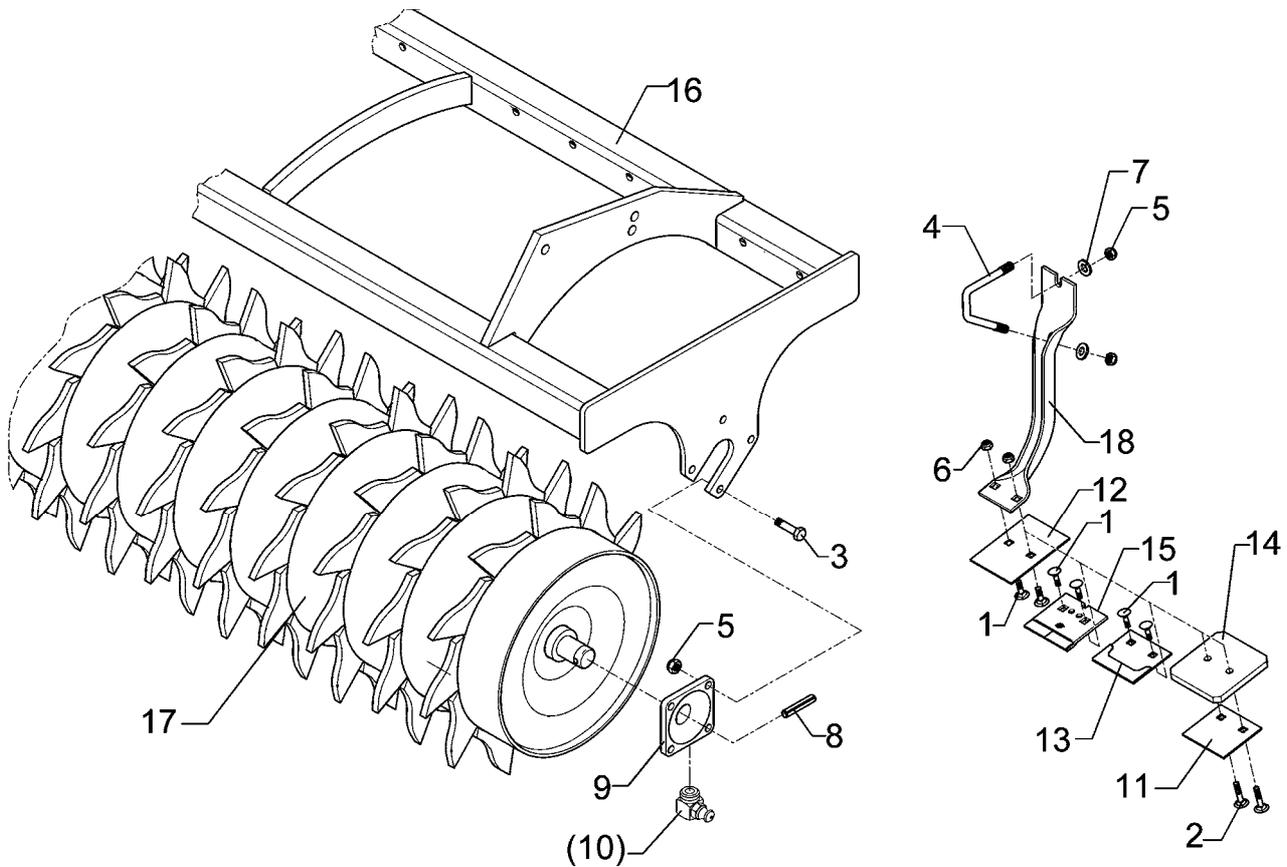

11.04

Pos.	Art.-Nr.	Stk.	Artikeltext / Description	Abmessung	
1	301 1700	2	Flachrundschaube DIN603	Bolt, cup square head	M10x20-8.8
2	301 1706	2	Flachrundschaube DIN603	Bolt, cup square head	M10x30-8.8 Zn
3	301 3348	8	Sechskantschraube DIN933	Screw	M12x40-8.8
4	301 7788	24	Bügelsschraube	U-bolt	M12/43/94/8.8 Zn
5	303 0934	56	Sicherungsmutter	Selflocking nut	DIN985-NM12-8 Zn
6	303 0970	2	Sechskantmutter	Nut	M10 DIN934-8
7	305 6136	48	Scheibe	Washer	13/25x3 DIN1441-St
8	309 6072	2	Spannhülse	Expansion bush	8x40-DIN1481 Zn
9	319 9365	2	Flanschlager-Gehäuseeinheit	Bearing cpl.	RCJ 35 35x118x39,9
10	323 6360	2	Schmiernippel	Grease nipple	R1/8
11	349 2000	1	Abstreifer-Stützplatte	Scraper plate	90x3x85
12	349 2001	1	Abstreifer	Scraper	90x3x130
13	349 2002	1	Abstreifer aufgepanzert	Scraper, hardfaced	90x3x85
14	349 2003	1	Kunststoffabstreifer	Synthetic scraper	110x120x12
15	349 2004	1	Hartmetallabstreifer	Scraper	90x5x94
16	422 6345	1	Tragrahmen	Frame	ZPW D500-300 A
17	423 2136	1	Zahnpackerwalze	Packer roller	ZPW D500-3,0m
18	423 5905	1	Abstreiferhalter	Carrier for scraper	70x5x375-D500

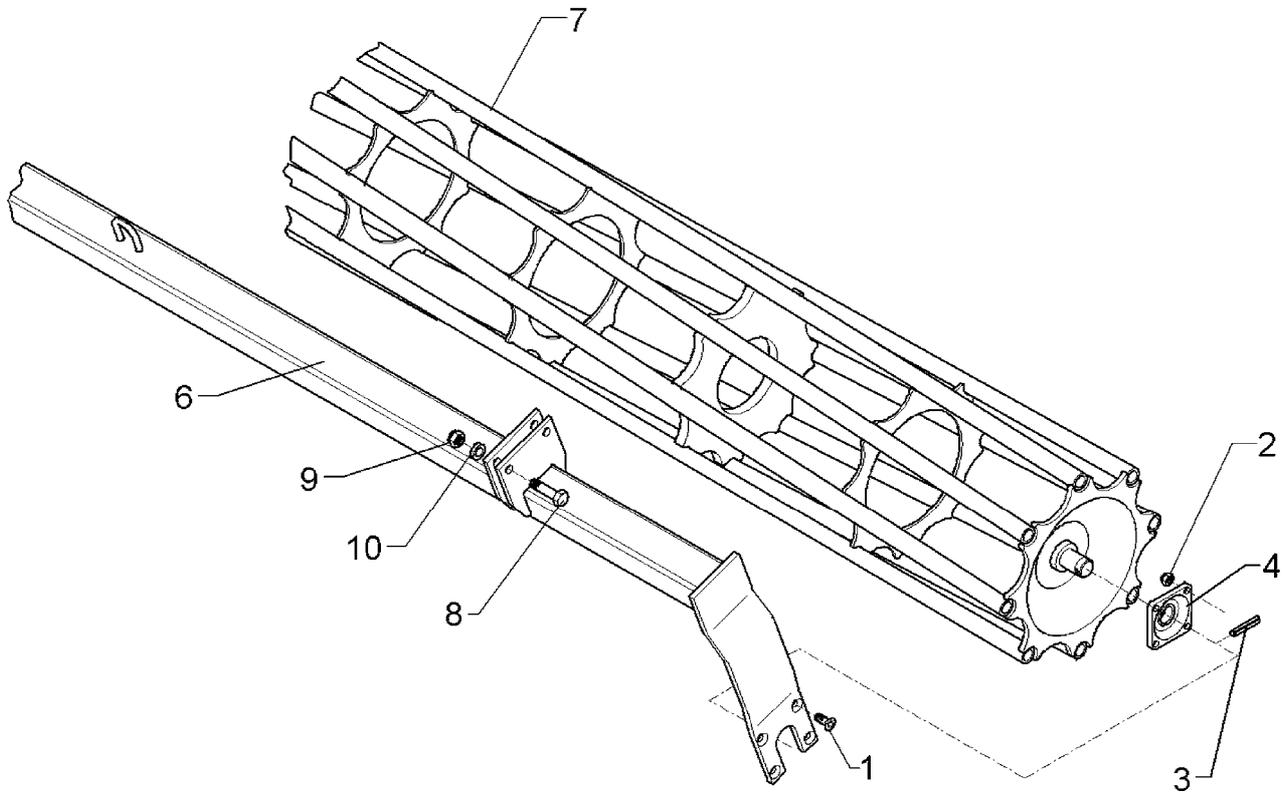

11.04

Pos.	Art.-Nr.	Stk.	Artikeltext / Description		Abmessung
1	301 6130	8	Senkschraube DIN7991-A	Countersunk bolt	M12x40-10.9
2	303 0934	8	Sicherungsmutter	Selflocking nut	DIN985-NM12-8 Zn
3	309 6072	2	Spannhülse	Expansion bush	8x40-DIN1481 Zn
4	319 9365	2	Flanschlager-Gehäuseeinheit	Bearing cpl.	RCJ 35 35x118x39,9
6	422 6602	1	Tragrahmen	Frame	80x2910 D400-300-K
7	423 0943	1	Rohrstabwalze	Tube bar roller	D400x2954-V RE 3.00
8	301 3870	4	Sechskantschraube spz.	Bolt	M16x65-10.9
9	303 0935	4	Sicherungsmutter	Selflocking nut	DIN985-NM16-8 Zn
10	305 6155	4	Scheibe	Washer	D30/17x6 St-37

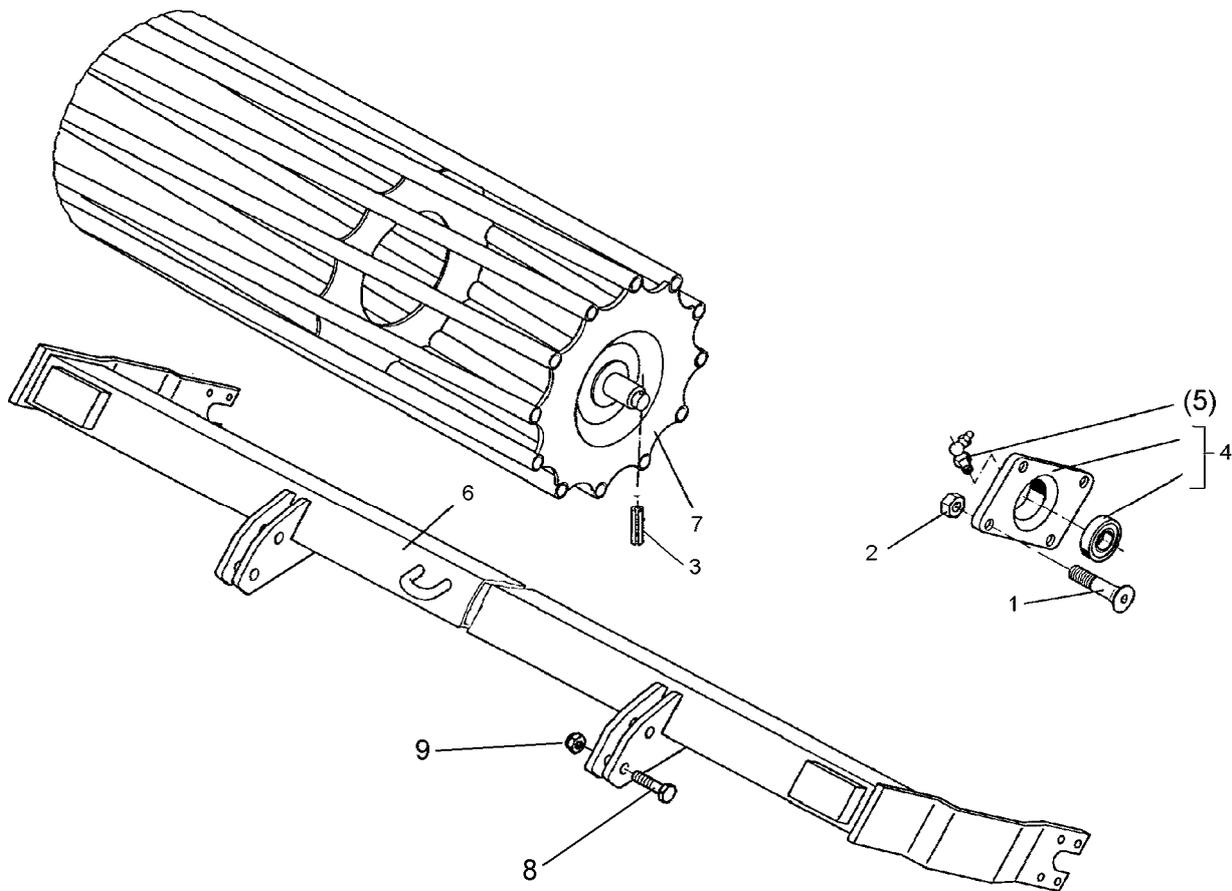

11.04

Pos.	Art.-Nr.	Stk.	Artikeltext / Description		Abmessung
1	301 6130	8	Senkschraube DIN7991-A	Countersunk bolt	M12x40-10.9
2	303 0934	8	Sicherungsmutter	Selflocking nut	DIN985-NM12-8 Zn
3	309 6072	2	Spannhülse	Expansion bush	8x40-DIN1481 Zn
4	319 9365	2	Flanschlager-Gehäuseeinheit	Bearing cpl.	RCJ 35 35x118x39,9
5	323 6360	2	Schmiernippel	Grease nipple	R1/8
6	422 6608	1	Tragrahmen	Frame	80x2910 D540-300-RE
7	423 0938	1	Rohrstabwalze	Tube bar roller	D540x2954 RE 3.00
8	301 3870	4	Sechskantschraube spz.	Bolt	M16x65-10.9
9	303 0935	4	Sicherungsmutter	Selflocking nut	DIN985-NM16-8 Zn
10	305 6155	4	Scheibe	Washer	D30/17x6 St-37

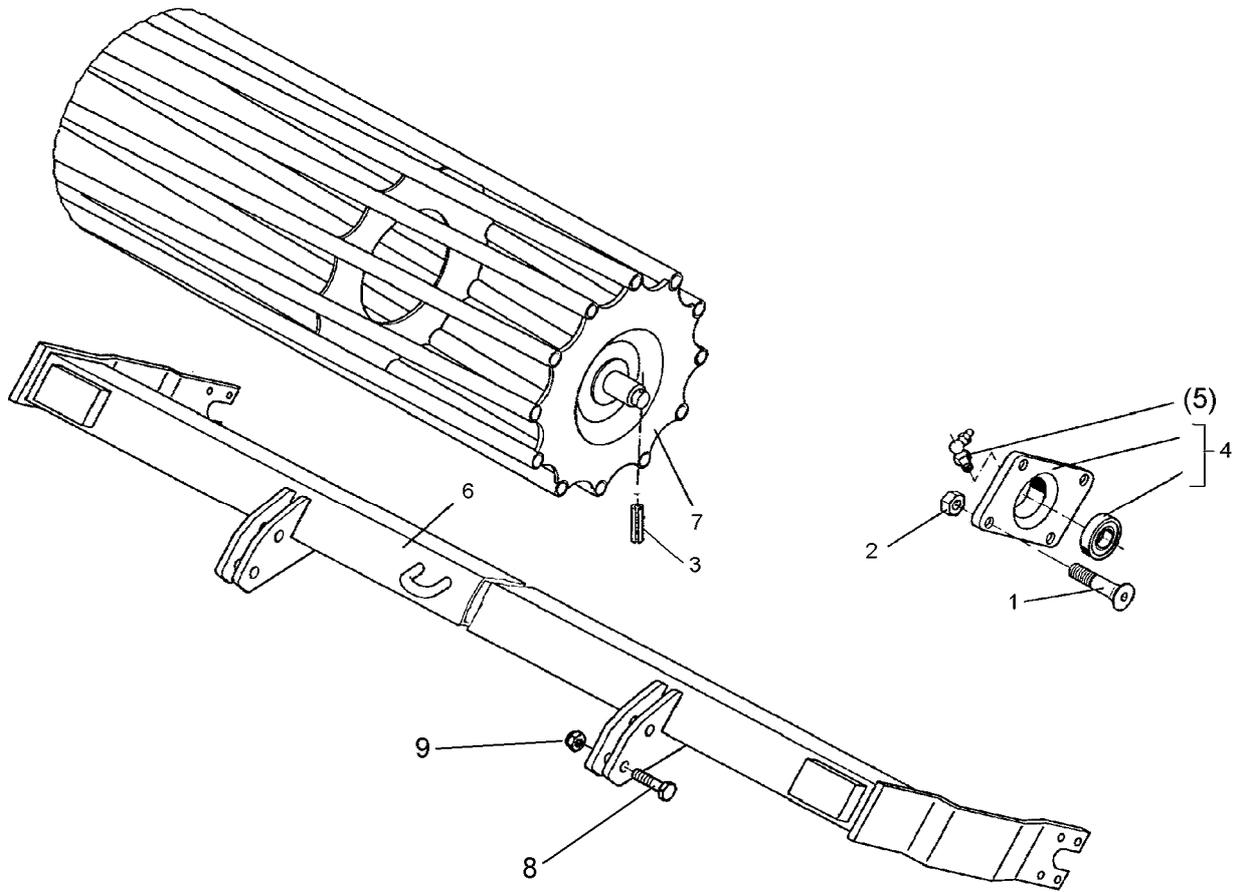

11.04

Pos.	Art.-Nr.	Stk.	Artikeltext / Description		Abmessung
1	301 6130	8	Senkschraube DIN7991-A	Countersunk bolt	M12x40-10.9
2	303 0934	8	Sicherungsmutter	Selflocking nut	DIN985-NM12-8 Zn
3	309 6072	2	Spannhülse	Expansion bush	8x40-DIN1481 Zn
4	319 9365	2	Flanschlager-Gehäuseeinheit	Bearing cpl.	RCJ 35 35x118x39,9
5	323 6360	2	Schmiernippel	Grease nipple	R1/8
6	422 6609	1	Tragrahmen	Frame	80x2910 D540-300-LI
7	423 0938	1	Rohrstabwalze	Tube bar roller	D540x2954 RE 3.00
8	301 3870	4	Sechskantschraube spz.	Bolt	M16x65-10.9
9	303 0935	4	Sicherungsmutter	Selflocking nut	DIN985-NM16-8 Zn
10	305 6155	4	Scheibe	Washer	D30/17x6 St-37

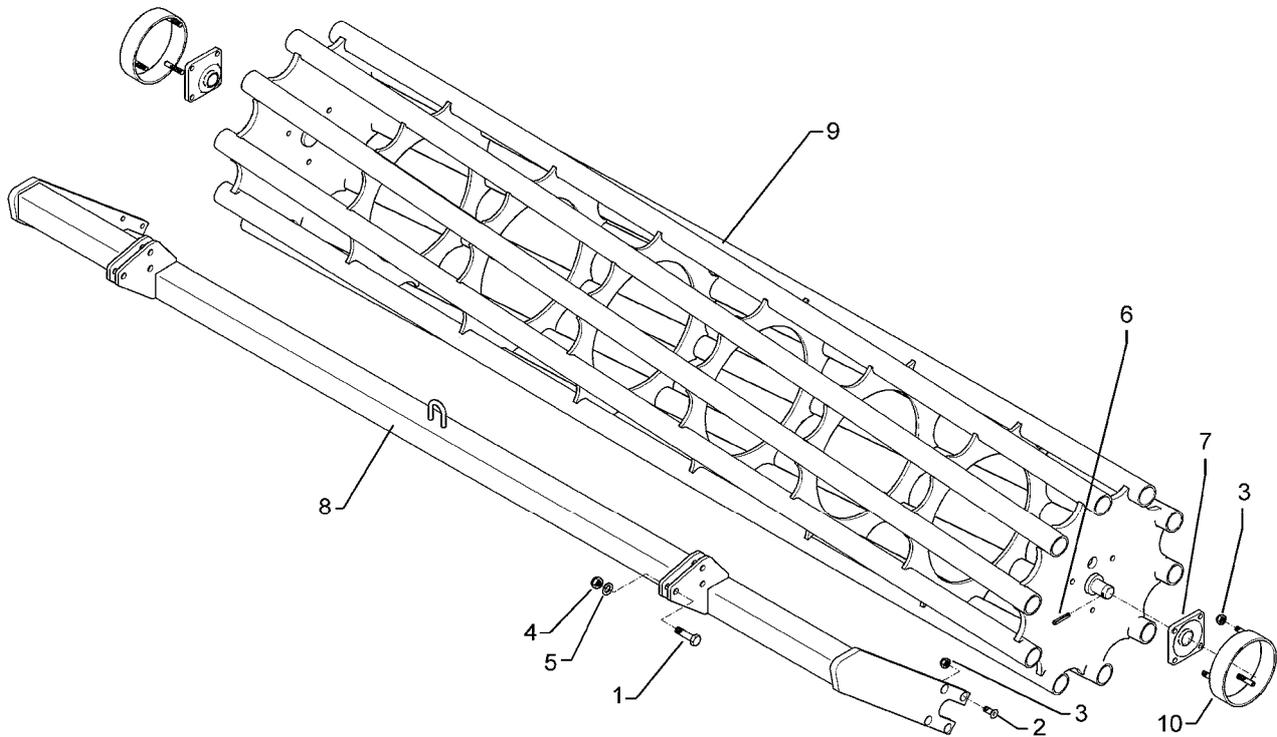

11.04

Pos.	Art.-Nr.	Stk.	Artikeltext / Description		Abmessung
1	301 3870	6	Sechskantschraube spz.	Bolt	M16x65-10.9
2	301 6132	8	Senkschraube DIN7991-A	Countersunk bolt	M12x50-10.9
3	303 0934	8	Sicherungsmutter	Selflocking nut	DIN985-NM12-8 Zn
4	303 0935	6	Sicherungsmutter	Selflocking nut	DIN985-NM16-8 Zn
5	305 6155	6	Scheibe	Washer	D30/17x6 St-37
6	309 6072	2	Spannhülse	Expansion bush	8x40-DIN1481 Zn
7	319 9365	2	Flanschlager-Gehäuseeinheit	Bearing cpl.	RCJ 35 35x118x39,9
8	422 6628	1	Tragrahmen	Frame	80 D600-3.00 SM9 RE
9	423 0972	1	Rohrstabwalze	Tube bar roller	D600-3.00 SM9
10	423 5860	2	Wickelschutz	Guard	RSW600 D193,7x6,3x48 3xM12

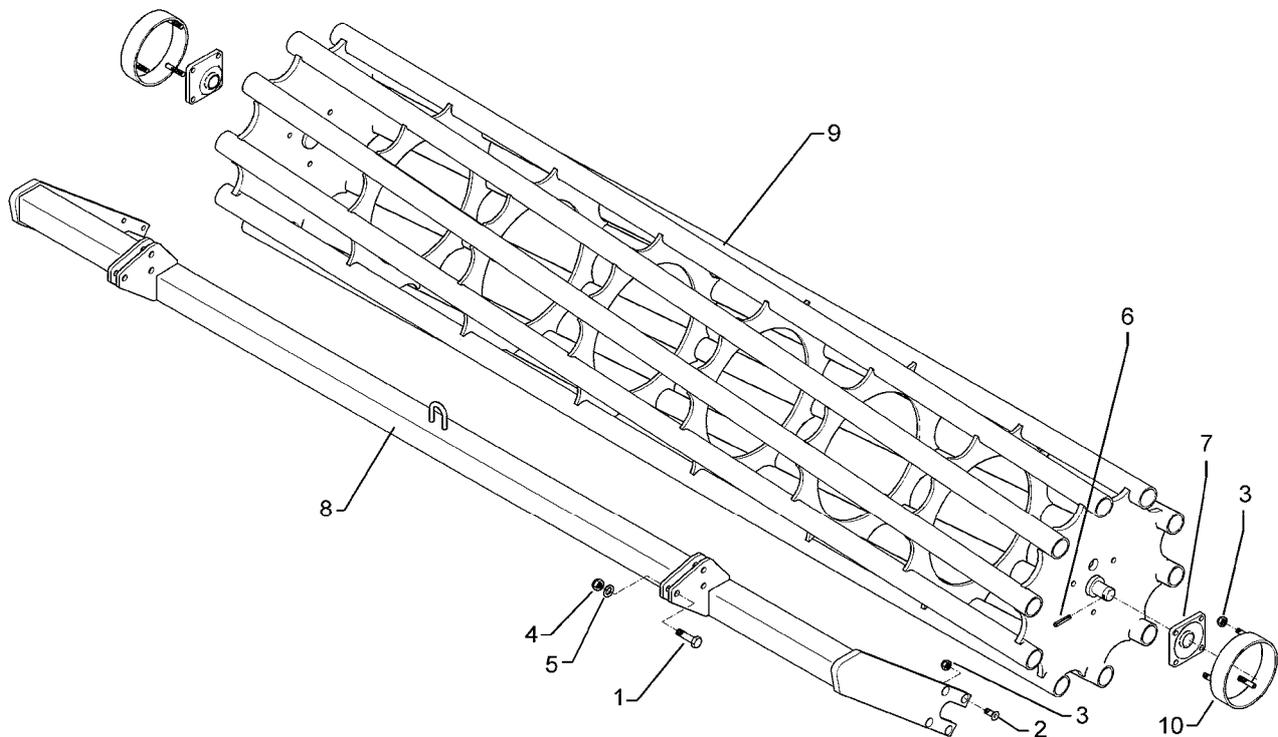

11.04

Pos.	Art.-Nr.	Stk.	Artikeltext / Description		Abmessung
1	301 3870	6	Sechskantschraube spz.	Bolt	M16x65-10.9
2	301 6132	8	Senkschraube DIN7991-A	Countersunk bolt	M12x50-10.9
3	303 0934	8	Sicherungsmutter	Selflocking nut	DIN985-NM12-8 Zn
4	303 0935	6	Sicherungsmutter	Selflocking nut	DIN985-NM16-8 Zn
5	305 6155	6	Scheibe	Washer	D30/17x6 St-37
6	309 6072	2	Spannhülse	Expansion bush	8x40-DIN1481 Zn
7	319 9365	2	Flanschlager-Gehäuseeinheit	Bearing cpl.	RCJ 35 35x118x39,9
8	422 6629	1	Tragrahmen	Frame	80 D600-3.00 SM9 LI
9	423 0972	1	Rohrstabwalze	Tube bar roller	D600-3.00 SM9
10	423 5860	2	Wickelschutz	Guard	RSW600 D193,7x6,3x48 3xM12

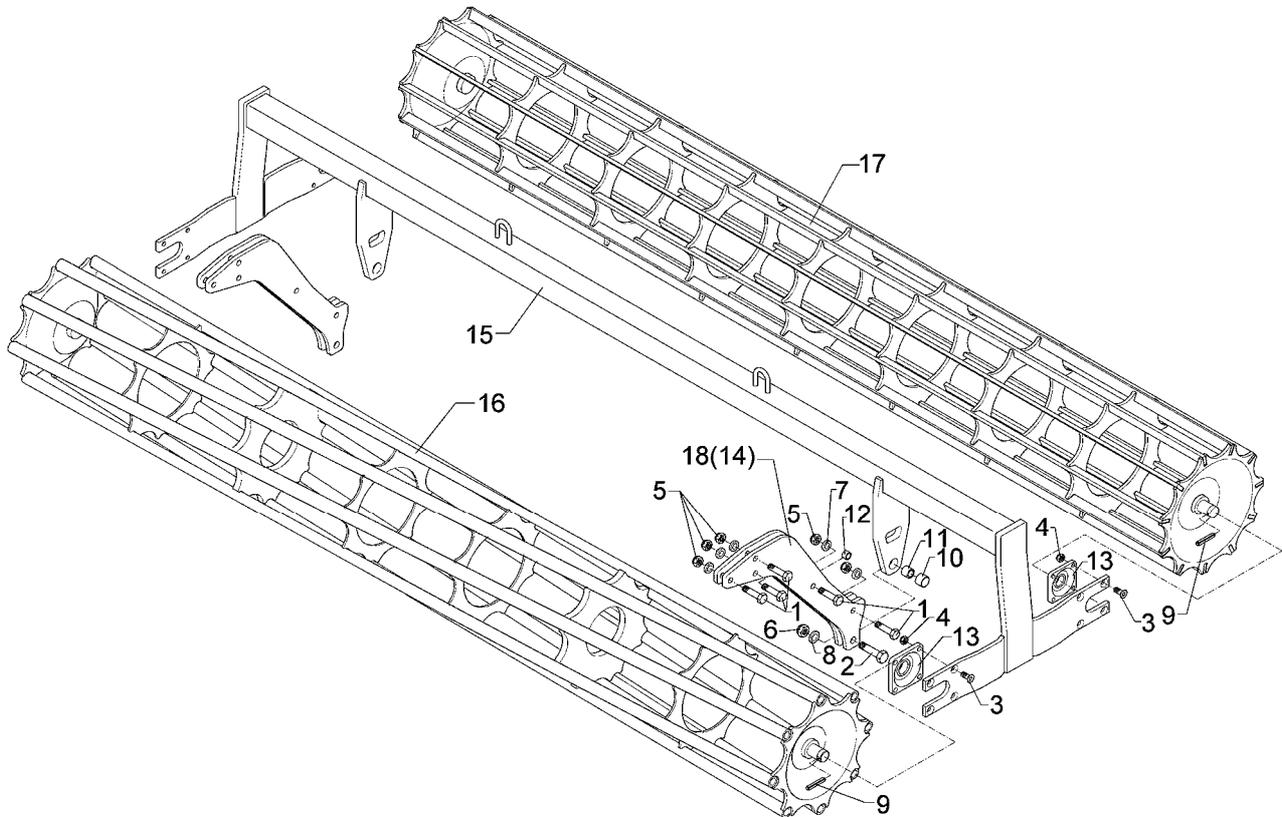

11.04

Pos.	Art.-Nr.	Stk.	Artikeltext / Description		Abmessung
1	301 5360	10	Sechskantschraube spz.	Bolt	M16x70-12.9
2	301 4602	2	Sechskantschraube spz.	Bolt	M20x75-8.8
3	301 6130	16	Senkschraube DIN7991-A	Countersunk bolt	M12x40-10.9
4	303 0934	16	Sicherungsmutter	Selflocking nut	DIN985-NM12-8 Zn
5	303 0935	10	Sicherungsmutter	Selflocking nut	DIN985-NM16-8 Zn
6	303 0936	2	Sicherungsmutter	Selflocking nut	DIN985-NM20-8 Zn
7	305 6155	10	Scheibe	Washer	D30/17x6 St-37
8	305 6164	2	Scheibe	Washer	D35/20,5x5
9	309 6072	4	Spannhülse	Expansion bush	8x40-DIN1481 Zn
10	317 3352	2	Einspannbuchse mit Preßsitz	Expansion bush	EG28/32x20
11	317 6657	2	Buchse	Bush	D20/28x22
12	317 6658	2	Buchse	Bush	D16/22x22
13	319 9365	4	Flanschlager-Gehäuseeinheit	Bearing cpl.	RCJ 35 35x118x39,9
14	417 8113	4	Platte	Plate	12x490x510
15	422 6688	1	Tragrahmen	Frame	80x2910 2xD400-300-K
16	423 0943	1	Rohrstabwalze	Tube bar roller	D400x2954-V RE 3.00
17	423 1009	1	Flachstabwalze	Flat bar roller	D400x2954/11 3.00
18	417 8114	4	Platte	Plate	12x540x510

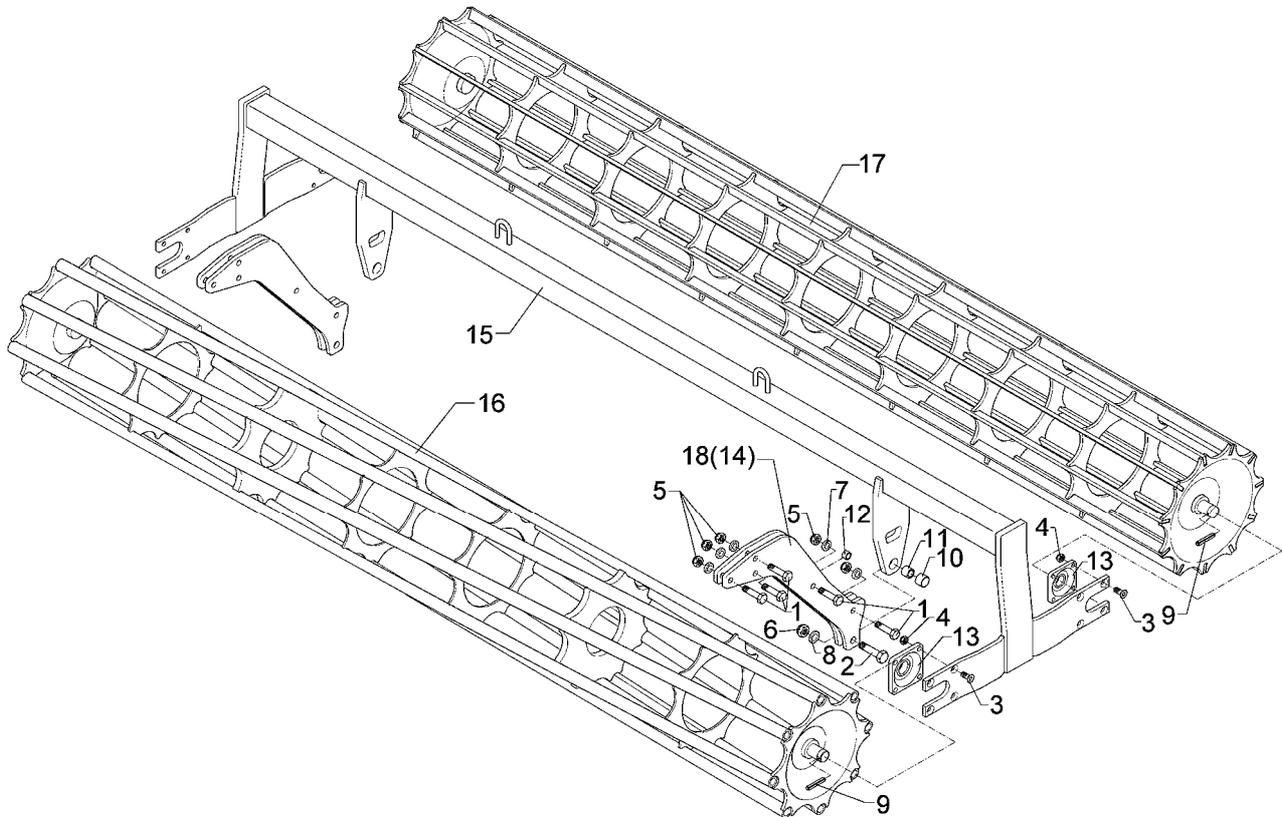

11.04

Pos.	Art.-Nr.	Stk.	Artikeltext / Description		Abmessung
1	301 5360	10	Sechskantschraube spz.	Bolt	M16x70-12.9
2	301 4602	2	Sechskantschraube spz.	Bolt	M20x75-8.8
3	301 6130	16	Senkschraube DIN7991-A	Countersunk bolt	M12x40-10.9
4	303 0934	16	Sicherungsmutter	Selflocking nut	DIN985-NM12-8 Zn
5	303 0935	10	Sicherungsmutter	Selflocking nut	DIN985-NM16-8 Zn
6	303 0936	2	Sicherungsmutter	Selflocking nut	DIN985-NM20-8 Zn
7	305 6155	10	Scheibe	Washer	D30/17x6 St-37
8	305 6164	2	Scheibe	Washer	D35/20,5x5
9	309 6072	4	Spannhülse	Expansion bush	8x40-DIN1481 Zn
10	317 3352	2	Einspannbuchse mit Preßsitz	Expansion bush	EG28/32x20
11	317 6657	2	Buchse	Bush	D20/28x22
12	317 6658	2	Buchse	Bush	D16/22x22
13	319 9365	4	Flanschlager-Gehäuseeinheit	Bearing cpl.	RCJ 35 35x118x39,9
14	417 8113	4	Platte	Plate	12x490x510
15	422 6688	1	Tragrahmen	Frame	80x2910 2xD400-300-K
16	423 0943	1	Rohrstabwalze	Tube bar roller	D400x2954-V RE 3.00
17	423 1009	1	Flachstabwalze	Flat bar roller	D400x2954/11 3.00
18	417 8114	4	Platte	Plate	12x540x510

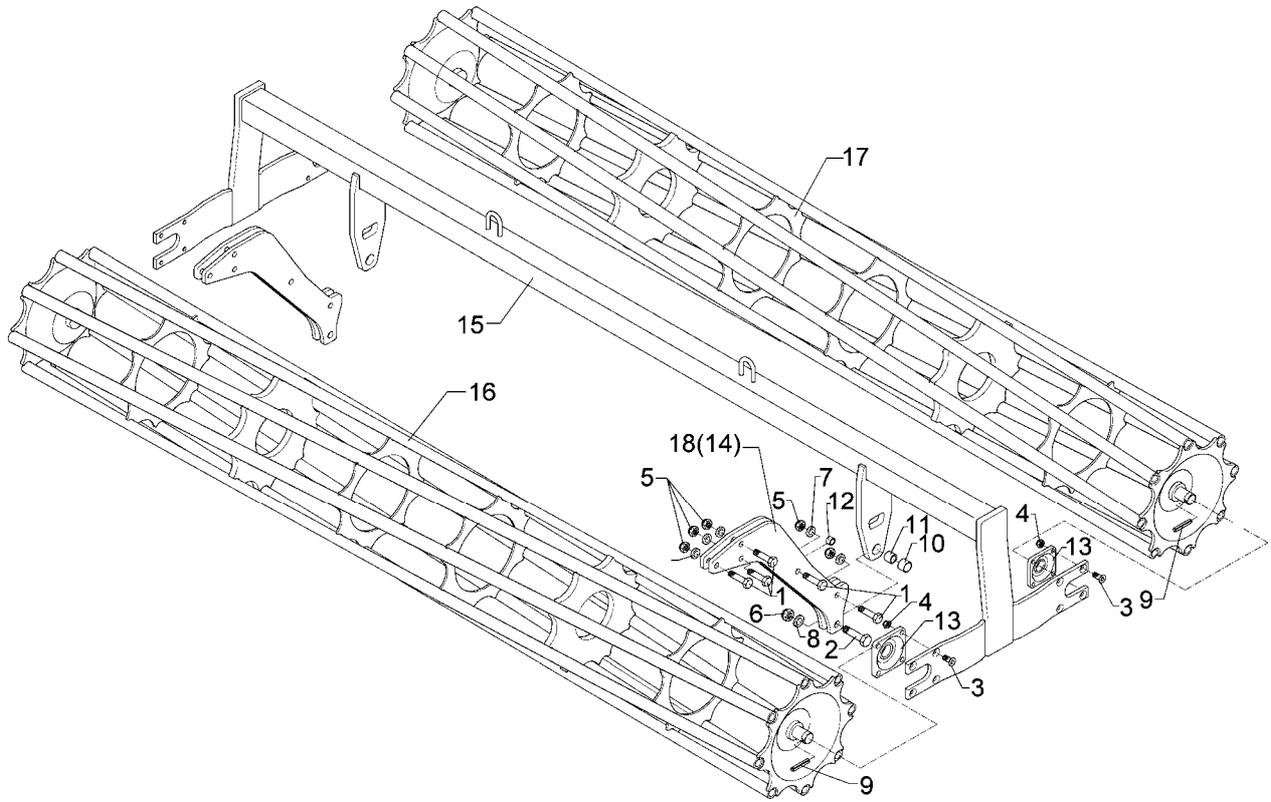

11.04

Pos.	Art.-Nr.	Stk.	Artikeltext / Description		Abmessung
1	301 5360	10	Sechskantschraube spz.	Bolt	M16x70-12.9
2	301 4602	2	Sechskantschraube spz.	Bolt	M20x75-8.8
3	301 6130	16	Senkschraube DIN7991-A	Countersunk bolt	M12x40-10.9
4	303 0934	16	Sicherungsmutter	Selflocking nut	DIN985-NM12-8 Zn
5	303 0935	10	Sicherungsmutter	Selflocking nut	DIN985-NM16-8 Zn
6	303 0936	2	Sicherungsmutter	Selflocking nut	DIN985-NM20-8 Zn
7	305 6155	10	Scheibe	Washer	D30/17x6 St-37
8	305 6164	2	Scheibe	Washer	D35/20,5x5
9	309 6072	4	Spannhülse	Expansion bush	8x40-DIN1481 Zn
10	317 3352	2	Einspannbuchse mit Preßsitz	Expansion bush	EG28/32x20
11	317 6657	2	Buchse	Bush	D20/28x22
12	317 6658	2	Buchse	Bush	D16/22x22
13	319 9365	4	Flanschlager-Gehäuseeinheit	Bearing cpl.	RCJ 35 35x118x39,9
14	417 8113	4	Platte	Plate	12x490x510
15	422 6688	1	Tragrahmen	Frame	80x2910 2xD400-300-K
16	423 0943	1	Rohrstabwalze	Tube bar roller	D400x2954-V RE 3.00
17	423 0963	1	Rohrstabwalze	Tube bar roller	D400x2954-V LI 3.00
18	417 8114	4	Platte	Plate	12x540x510

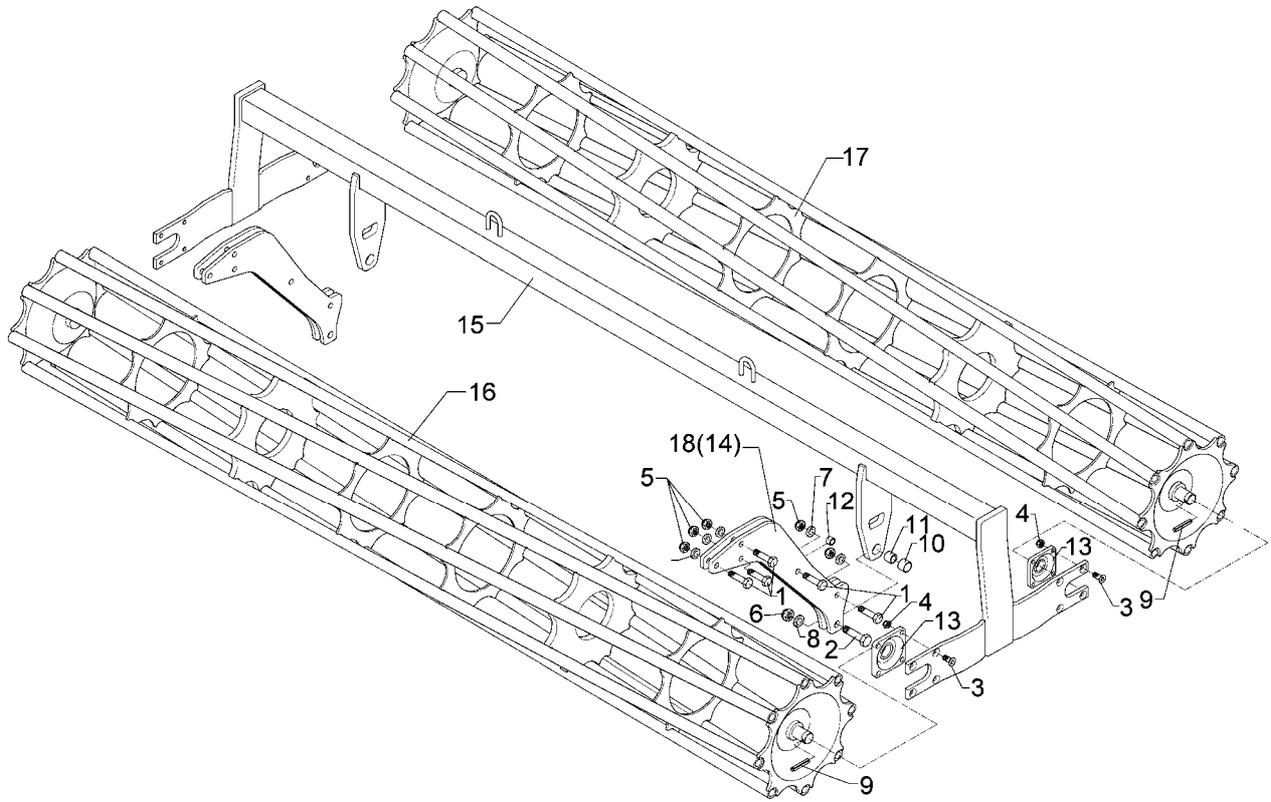

11.04

Pos.	Art.-Nr.	Stk.	Artikeltext / Description		Abmessung
1	301 5360	10	Sechskantschraube spz.	Bolt	M16x70-12.9
2	301 4602	2	Sechskantschraube spz.	Bolt	M20x75-8.8
3	301 6130	16	Senkschraube DIN7991-A	Countersunk bolt	M12x40-10.9
4	303 0934	16	Sicherungsmutter	Selflocking nut	DIN985-NM12-8 Zn
5	303 0935	10	Sicherungsmutter	Selflocking nut	DIN985-NM16-8 Zn
6	303 0936	2	Sicherungsmutter	Selflocking nut	DIN985-NM20-8 Zn
7	305 6155	10	Scheibe	Washer	D30/17x6 St-37
8	305 6164	2	Scheibe	Washer	D35/20,5x5
9	309 6072	4	Spannhülse	Expansion bush	8x40-DIN1481 Zn
10	317 3352	2	Einspannbuchse mit Preßsitz	Expansion bush	EG28/32x20
11	317 6657	2	Buchse	Bush	D20/28x22
12	317 6658	2	Buchse	Bush	D16/22x22
13	319 9365	4	Flanschlager-Gehäuseeinheit	Bearing cpl.	RCJ 35 35x118x39,9
14	417 8113	4	Platte	Plate	12x490x510
15	422 6688	1	Tragrahmen	Frame	80x2910 2xD400-300-K
16	423 0943	1	Rohrstabwalze	Tube bar roller	D400x2954-V RE 3.00
17	423 0963	1	Rohrstabwalze	Tube bar roller	D400x2954-V LI 3.00
18	417 8114	4	Platte	Plate	12x540x510

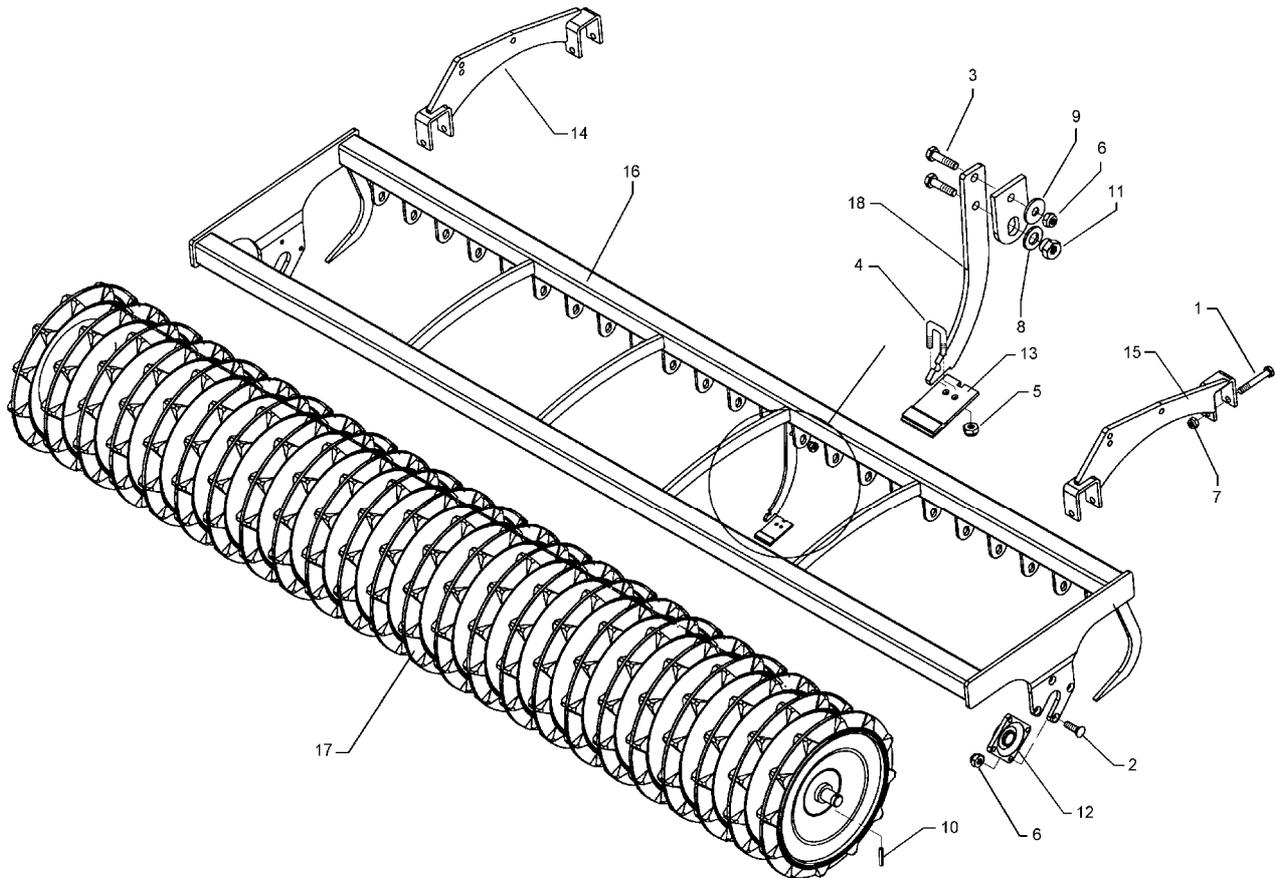

11.04

Pos.	Art.-Nr.	Stk.	Artikeltext / Description		Abmessung
1	301 4019	4	Sechskantschraube DIN931-A	Bolt	M16x110-8.8
2	301 6130	8	Senkschraube DIN7991-A	Countersunk bolt	M12x40-10.9
3	301 7334	23	Sechskantschraube DIN933	Screw	M12x35-8.8 Zn
4	301 7760	23	Bügelsschraube	U-bolt	M8/17/26/8.8 Zn
5	303 0932	46	Sicherungsmutter	Selflocking nut	DIN985-NM8-8 Zn
6	303 0934	31	Sicherungsmutter	Selflocking nut	DIN985-NM12-8 Zn
7	303 0935	4	Sicherungsmutter	Selflocking nut	DIN985-NM16-8 Zn
8	305 6010	23	Scheibe	Washer	D20,5/28x3 Zn
9	305 6166	23	Scheibe	Washer	13/35x5
10	309 6072	2	Spannhülse	Expansion bush	8x40-DIN1481 Zn
11	317 7699	23	Exzenter	Eccentric	SW24/20-M12/E2
12	319 9365	2	Flanschlager-Gehäuseeinheit	Bearing cpl.	RCJ 35 35x118x39,9
13	349 2005	23	Hartmetallabstreifer	Scraper	60x5x94
14	422 2916	1	Tragplatte	Support plate	RE TRW
15	422 2917	1	Tragplatte	Support plate	LI TRW
16	422 6739	1	Tragrahmen	Frame	TPW D500-300-24R125
17	423 2143	1	Trapezpackerwalze	Trapeze packer roller	TPW D500-300-24R125
18	423 5906	23	Abstreiferhalter	Carrier for scraper	40x8x312

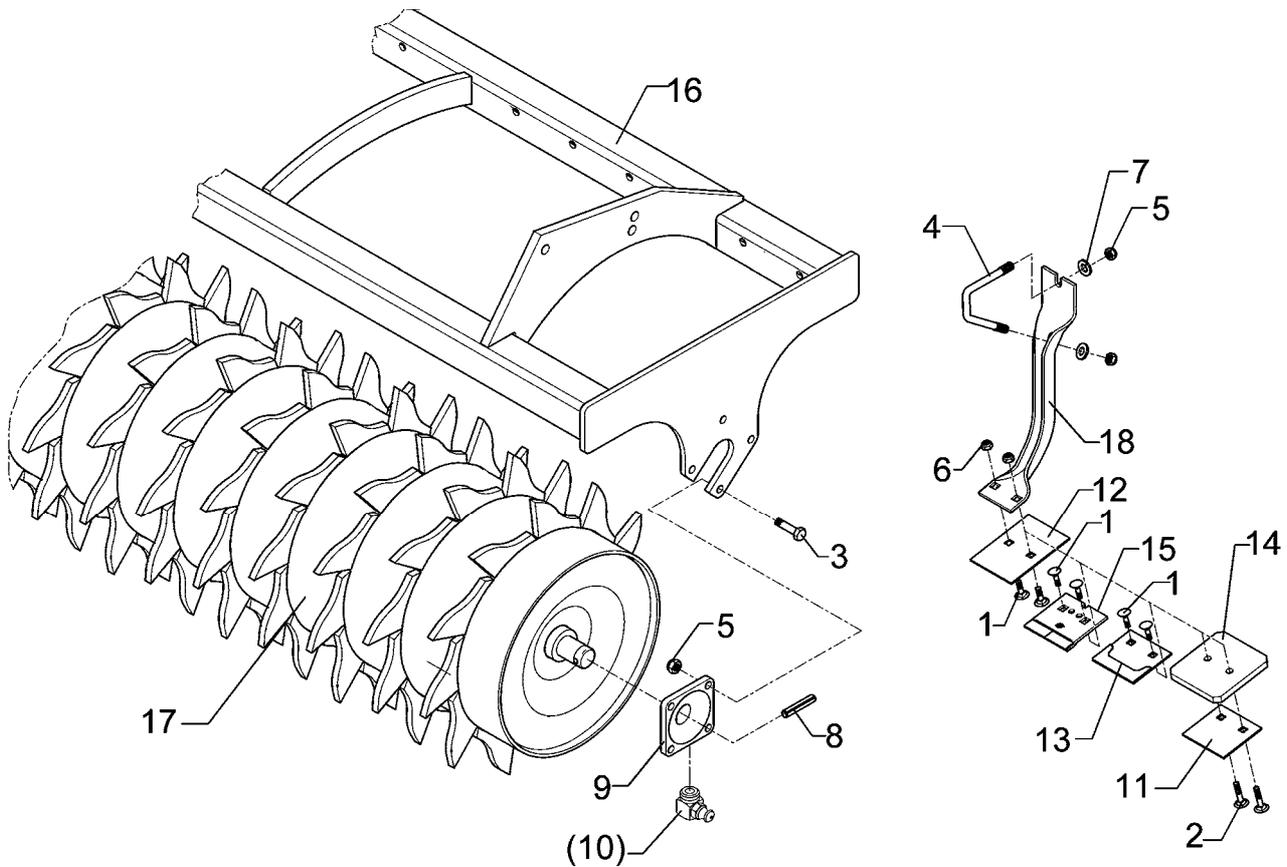

11.04

Pos.	Art.-Nr.	Stk.	Artikeltext / Description		Abmessung
1	301 1700	2	Flachrundschaube DIN603	Bolt, cup square head	M10x20-8.8
2	301 1706	2	Flachrundschaube DIN603	Bolt, cup square head	M10x30-8.8 Zn
3	301 3348	8	Sechskantschraube DIN933	Screw	M12x40-8.8
4	301 7788	24	Bügelsschraube	U-bolt	M12/43/94/8.8 Zn
5	303 0934	56	Sicherungsmutter	Selflocking nut	DIN985-NM12-8 Zn
6	303 0970	2	Sechskantmutter	Nut	M10 DIN934-8
7	305 6136	48	Scheibe	Washer	13/25x3 DIN1441-St
8	309 6072	2	Spannhülse	Expansion bush	8x40-DIN1481 Zn
9	319 9365	2	Flanschlager-Gehäuseeinheit	Bearing cpl.	RCJ 35 35x118x39,9
11	349 2000	1	Abstreifer-Stützplatte	Scraper plate	90x3x85
12	349 2001	1	Abstreifer	Scraper	90x3x130
13	349 2002	1	Abstreifer aufgepanzert	Scraper, hardfaced	90x3x85
14	349 2003	1	Kunststoffabstreifer	Synthetic scraper	110x120x12
15	349 2004	1	Hartmetallabstreifer	Scraper	90x5x94
16	422 6345	1	Tragrahmen	Frame	ZPW D500-300 A
17	423 2136	1	Zahnpackerwalze	Packer roller	ZPW D500-3,0m
18	423 5901	1	Abstreiferhalter	Carrier for scraper	50x6x337-D420

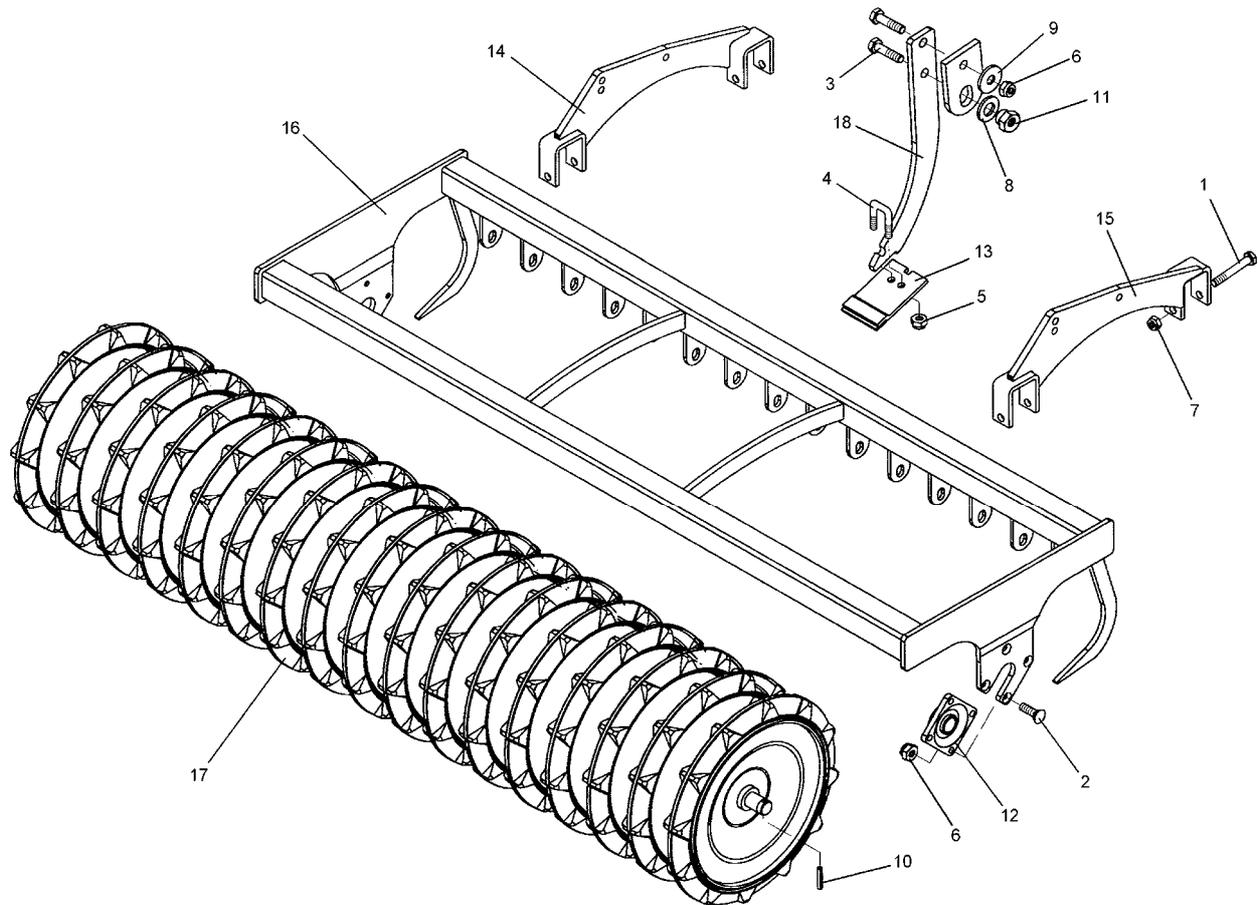

11.04

Pos.	Art.-Nr.	Stk.	Artikeltext / Description	Abmessung	
1	301 4019	4	Sechskantschraube DIN931-A	Bolt	M16x110-8.8
2	301 6130	8	Senkschraube DIN7991-A	Countersunk bolt	M12x40-10.9
3	301 7334	19	Sechskantschraube DIN933	Screw	M12x35-8.8 Zn
4	301 7760	19	Bügelschraube	U-bolt	M8/17/26/8.8 Zn
5	303 0932	38	Sicherungsmutter	Selflocking nut	DIN985-NM8-8 Zn
6	303 0934	27	Sicherungsmutter	Selflocking nut	DIN985-NM12-8 Zn
7	303 0935	4	Sicherungsmutter	Selflocking nut	DIN985-NM16-8 Zn
8	305 6010	19	Scheibe	Washer	D20,5/28x3 Zn
9	305 6166	19	Scheibe	Washer	13/35x5
10	309 6072	2	Spannhülse	Expansion bush	8x40-DIN1481 Zn
11	317 7699	19	Exzenter	Eccentric	SW24/20-M12/E2
12	319 9365	2	Flanschlager-Gehäuseeinheit	Bearing cpl.	RCJ 35 35x118x39,9
13	349 2004	19	Hartmetallabstreifer	Scraper	90x5x94
14	422 2916	1	Tragplatte	Support plate	RE TRW
15	422 2917	1	Tragplatte	Support plate	LI TRW
16	422 6752	1	Tragrahmen	Frame	TPW D500-300-20R150
17	423 2150	1	Trapezpackerwalze	Trapeze packer roller	TPW D500-300-20R150
18	423 5906	1	Abstreiferhalter	Carrier for scraper	40x8x312

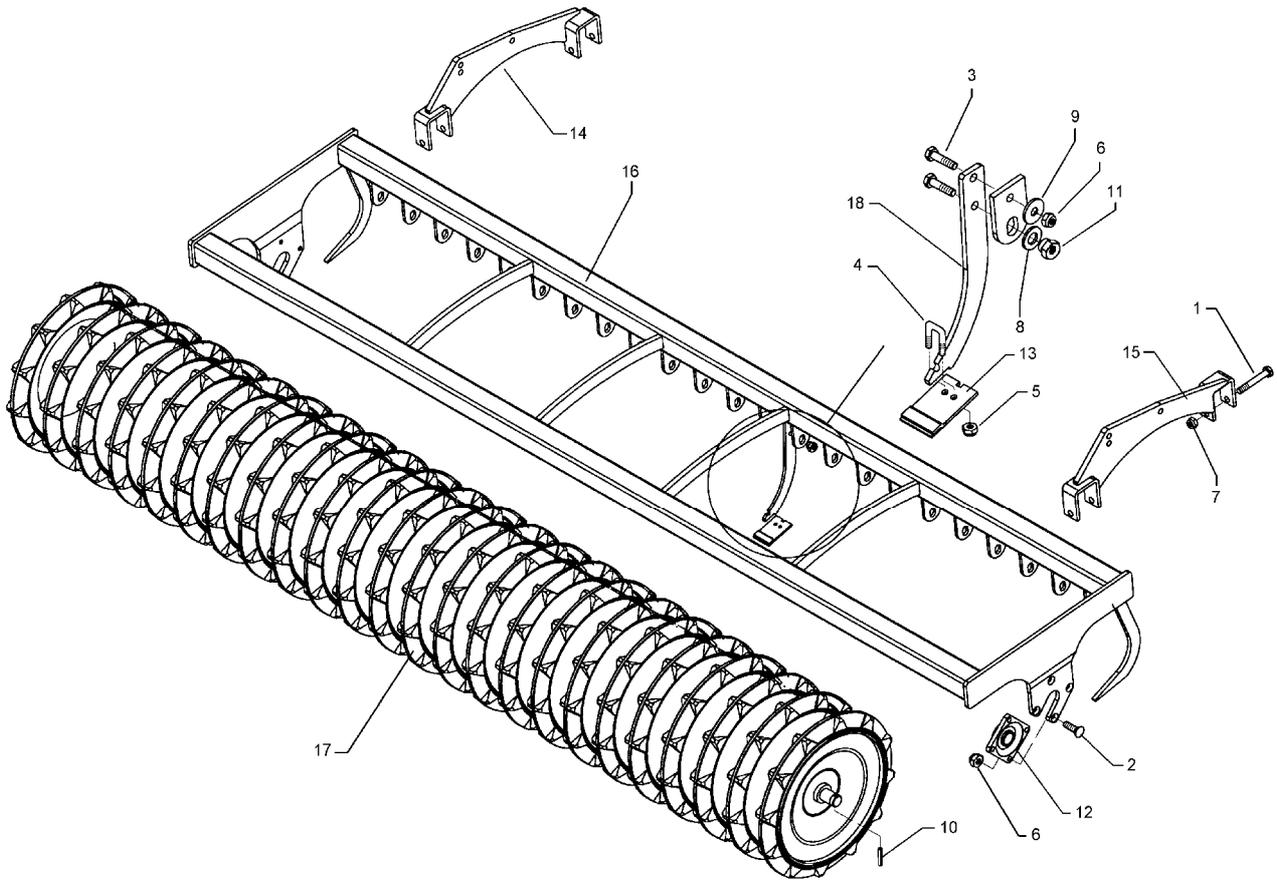

11.04

Pos.	Art.-Nr.	Stk.	Artikeltext / Description		Abmessung
1	301 4019	4	Sechskantschraube DIN931-A	Bolt	M16x110-8.8
2	301 6130	8	Senkschraube DIN7991-A	Countersunk bolt	M12x40-10.9
3	301 7334	16	Sechskantschraube DIN933	Screw	M12x35-8.8 Zn
4	301 7760	16	Bügelsschraube	U-bolt	M8/17/26/8.8 Zn
5	303 0932	32	Sicherungsmutter	Selflocking nut	DIN985-NM8-8 Zn
6	303 0934	24	Sicherungsmutter	Selflocking nut	DIN985-NM12-8 Zn
7	303 0935	4	Sicherungsmutter	Selflocking nut	DIN985-NM16-8 Zn
8	305 6010	16	Scheibe	Washer	D20,5/28x3 Zn
9	305 6166	16	Scheibe	Washer	13/35x5
10	309 6072	2	Spannhülse	Expansion bush	8x40-DIN1481 Zn
11	317 7699	16	Exzenter	Eccentric	SW24/20-M12/E2
12	319 9365	2	Flanschlager-Gehäuseeinheit	Bearing cpl.	RCJ 35 35x118x39,9
13	349 2006	16	Hartmetallabstreifer	Scraper	105x5x94
14	422 2916	1	Tragplatte	Support plate	RE TRW
15	422 2917	1	Tragplatte	Support plate	LI TRW
16	422 6760	1	Tragrahmen	Frame	TPW D500-300-17R175
17	423 2158	1	Trapezpackerwalze	Trapeze packer roller	TPW D500-300-17R175
18	423 5906	16	Abstreiferhalter	Carrier for scraper	40x8x312

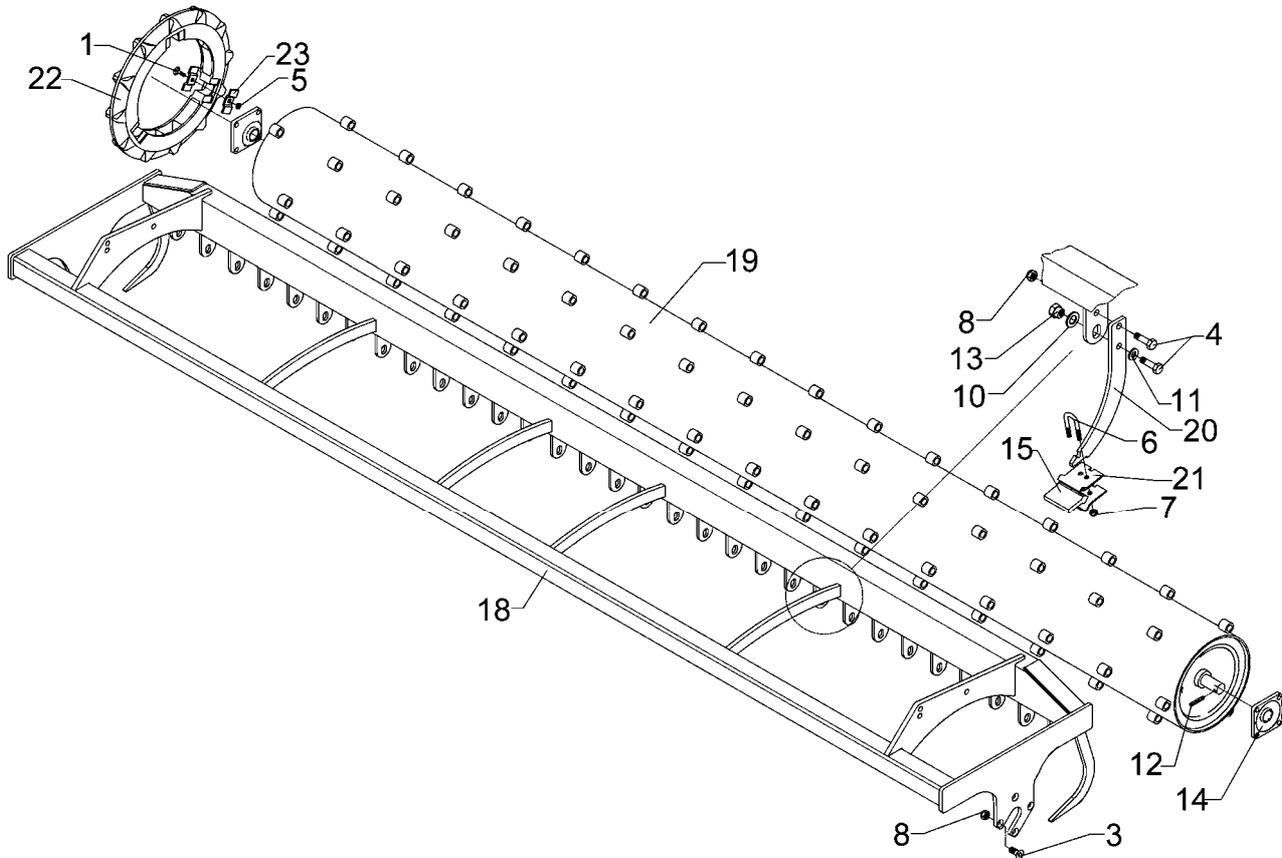

11.04

Pos.	Art.-Nr.	Stk.	Artikeltext / Description	Abmessung	
1	301 1719	96	Flachrundschaube DIN603	Bolt, cup square head	M10x47-8.8 Zn
3	301 6130	8	Senkschraube DIN7991-A	Countersunk bolt	M12x40-10.9
4	301 7334	62	Sechskantschraube DIN933	Screw	M12x35-8.8 Zn
5	303 0951	96	Sechskantmutter	Nut	BM10 DIN439-8 Zn
6	301 7760	32	Bügelsschraube	U-bolt	M8/17/26/8.8 Zn
7	303 0932	64	Sicherungsmutter	Selflocking nut	DIN985-NM8-8 Zn
8	303 0934	40	Sicherungsmutter	Selflocking nut	DIN985-NM12-8 Zn
10	305 6010	31	Scheibe	Washer	D20,5/28x3 Zn
11	305 6166	31	Scheibe	Washer	13/35x5
12	309 6072	2	Spannhülse	Expansion bush	8x40-DIN1481 Zn
13	317 7699	31	Exzenter	Eccentric	SW24/20-M12/E2
14	319 9365	2	Flanschlager-Gehäuseeinheit	Bearing cpl.	RCJ 35 35x118x39,9
15	349 2007	31	Kunststoffabstreifer	Synthetic scraper	68x53,5x10 TSW
18	422 6740	1	Tragrahmen	Frame	TPW D500-400-32R125
19	423 2165	1	Trapezscheibenwalze	Trapeze disc roller	TSW D500-400-32R125
20	423 5907	31	Abstreiferhalter	Carrier for scraper	40x8x287
21	423 5908	62	Klemmplatte	Clamping plate	60x3x66 2xD8,5
22	423 9043	32	Trapezring	Trapezring	D500x52
23	459 4550	192	Klemmplatte	Clamping plate	35x5x78 4XVKL M10

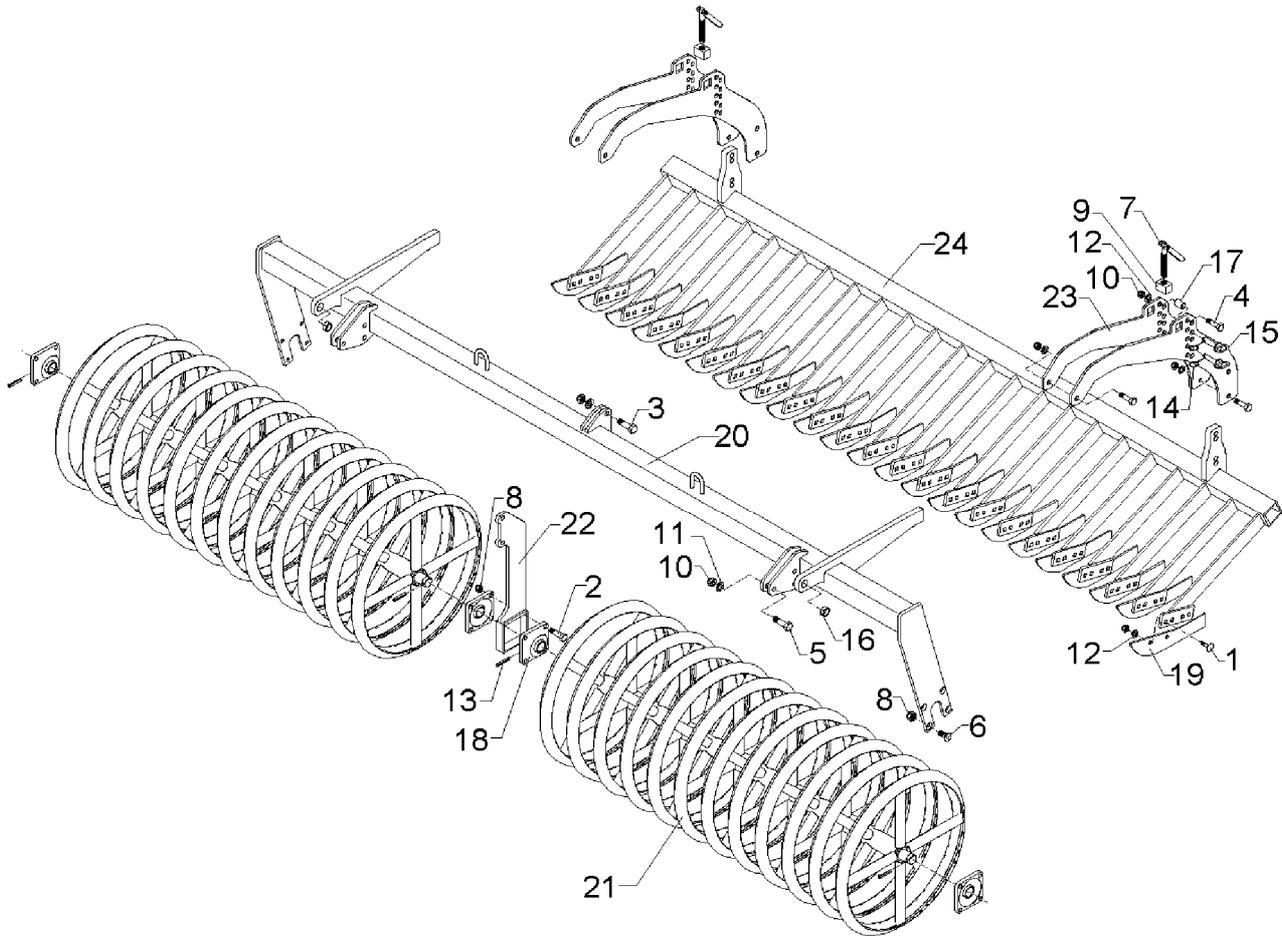

11.04

Pos.	Art.-Nr.	Stk.	Artikeltext / Description	Abmessung	
1	301 1805	46	Flachrundschaube mit Mutter	Bolt, cup square head	M12x30-10.9 MU
2	301 3407	4	Sechskantschraube DIN931-A	Bolt	M12x70-8.8
3	301 3779	2	Sechskantschraube spz.	Bolt	M16x60-10.9
4	301 3870	8	Sechskantschraube spz.	Bolt	M16x65-10.9
5	301 5360	6	Sechskantschraube spz.	Bolt	M16x70-12.9
6	301 6130	8	Senkschraube DIN7991-A	Countersunk bolt	M12x40-10.9
7	302 7933	2	Spindel kpl.	Screw cpl.	TR20x120-170
8	303 0934	12	Sicherungsmutter	Selflocking nut	DIN985-NM12-8 Zn
9	303 8644	2	Spindelmutter	Nut for screw	30x30x44 TR 20
10	303 0935	16	Sicherungsmutter	Selflocking nut	DIN985-NM16-8 Zn
11	305 6155	16	Scheibe	Washer	D30/17x6 St-37
12	305 9885	46	Federring	Spring ring	12 DIN127
13	309 6072	4	Spannhülse	Expansion bush	8x40-DIN1481 Zn
14	311 9565	4	Klappstift	Securing pin	4,5mm
15	313 1530	4	Bolzen mit Griff	Pin with grip	GB D15x41,8/60
16	317 3341	2	Einspannbuchse	Expansion bush	EG22/28x20-DIN1498
17	317 6658	4	Buchse	Bush	D16/22x22
18	319 9365	4	Flanschlager-Gehäuseeinheit	Bearing cpl.	RCJ 35 35x118x39,9
19	337 5002	23	Messer	Knife	6x347/50 2xD8,5-80
20	422 6810	1	Tragrahmen	Frame	80 MSW D600-300 RE SM9
21	423 2180	2	Messerwalze	Knife roller	MSW D600-1390-12R-125
22	422 6812	1	Tragplatte	Support plate	12x130x440 2xD16 MSW D600
23	422 6813	4	Verstellplatte	Adjuster plate	8x464x775 13xD16 MSW D600
24	422 6814	1	Messerbalken	Cutter bar	70x2800 23M SM.9/300

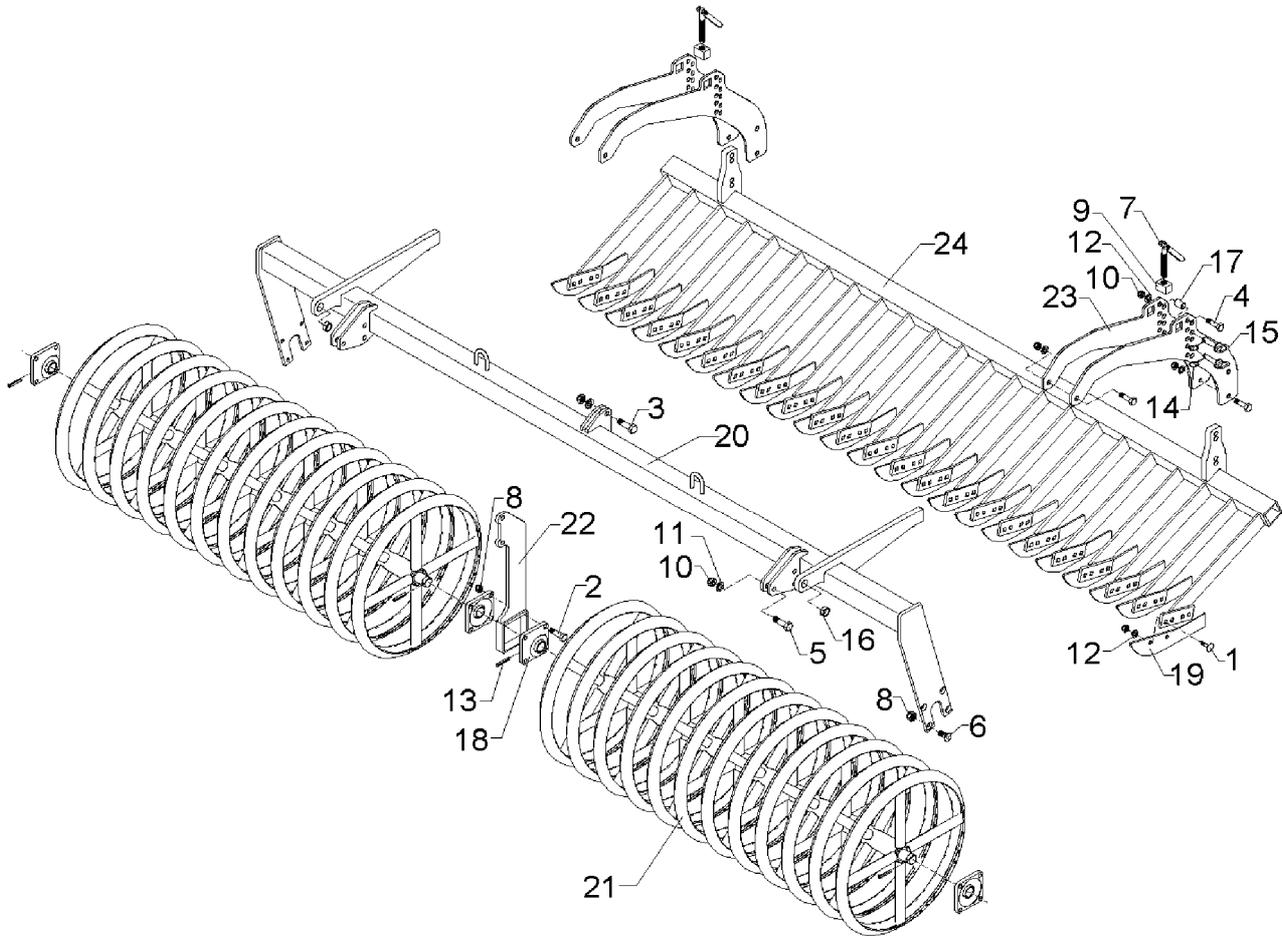

11.04

Pos.	Art.-Nr.	Stk.	Artikeltext / Description	Abmessung	
1	301 1805	48	Flachrundschaube mit Mutter	Bolt, cup square head	M12x30-10.9 MU
2	301 3407	4	Sechskantschraube DIN931-A	Bolt	M12x70-8.8
3	301 3779	2	Sechskantschraube spz.	Bolt	M16x60-10.9
4	301 3870	8	Sechskantschraube spz.	Bolt	M16x65-10.9
5	301 5360	6	Sechskantschraube spz.	Bolt	M16x70-12.9
6	301 6130	8	Senkschraube DIN7991-A	Countersunk bolt	M12x40-10.9
7	302 7933	2	Spindel kpl.	Screw cpl.	TR20x120-170
8	303 0934	12	Sicherungsmutter	Selflocking nut	DIN985-NM12-8 Zn
9	303 8644	2	Spindelmutter	Nut for screw	30x30x44 TR 20
10	303 0935	16	Sicherungsmutter	Selflocking nut	DIN985-NM16-8 Zn
11	305 6155	16	Scheibe	Washer	D30/17x6 St-37
12	305 9885	48	Federring	Spring ring	12 DIN127
13	309 6072	4	Spannhülse	Expansion bush	8x40-DIN1481 Zn
14	311 9565	4	Klappstift	Securing pin	4,5mm
15	313 1530	4	Bolzen mit Griff	Pin with grip	GB D15x41,8/60
16	317 3341	2	Einspannbuchse	Expansion bush	EG22/28x20-DIN1498
17	317 6658	4	Buchse	Bush	D16/22x22
18	319 9365	4	Flanschlager-Gehäuseeinheit	Bearing cpl.	RCJ 35 35x118x39,9
19	337 5002	24	Messer	Knife	6x347/50 2xD8,5-80
20	422 6811	1	Tragrahmen	Frame	80 MSW D600-300 LI SM9
21	423 2180	2	Messerwalze	Knife roller	MSW D600-1390-12R-125
22	422 6812	1	Tragplatte	Support plate	12x130x440 2xD16 MSW D600
23	422 6813	4	Verstellplatte	Adjuster plate	8x464x775 13xD16 MSW D600
24	422 6823	1	Messerbalken	Cutter bar	70x2925 24M SM.9/600 LI

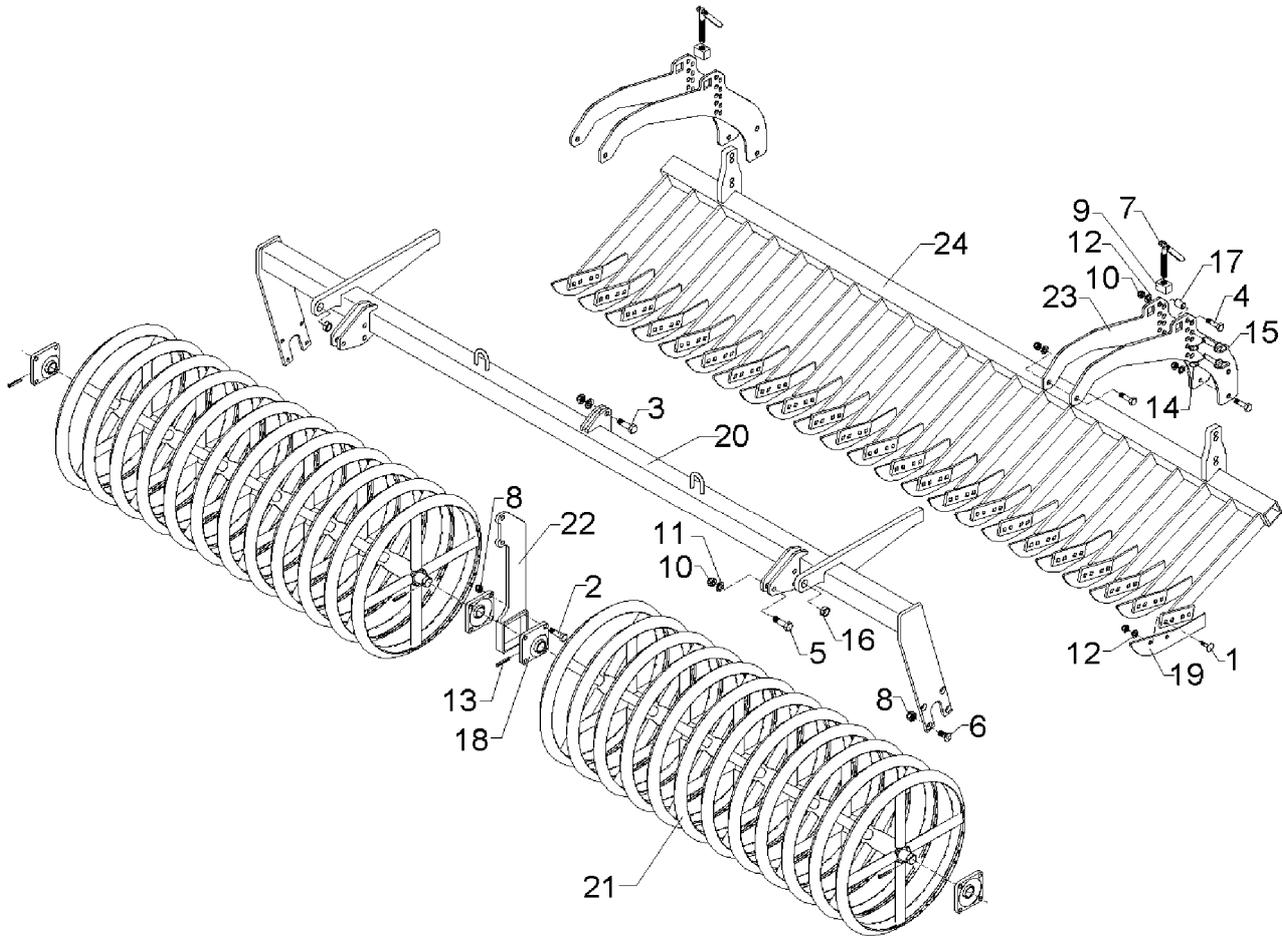

11.04

Pos.	Art.-Nr.	Stk.	Artikeltext / Description	Abmessung	
1	301 1805	46	Flachrundschaube mit Mutter	Bolt, cup square head	M12x30-10.9 MU
2	301 3407	4	Sechskantschraube DIN931-A	Bolt	M12x70-8.8
3	301 3779	2	Sechskantschraube spz.	Bolt	M16x60-10.9
4	301 3870	8	Sechskantschraube spz.	Bolt	M16x65-10.9
5	301 5360	6	Sechskantschraube spz.	Bolt	M16x70-12.9
6	301 6130	8	Senkschraube DIN7991-A	Countersunk bolt	M12x40-10.9
7	302 7933	2	Spindel kpl.	Screw cpl.	TR20x120-170
8	303 0934	12	Sicherungsmutter	Selflocking nut	DIN985-NM12-8 Zn
9	303 8644	2	Spindelmutter	Nut for screw	30x30x44 TR 20
10	303 0935	16	Sicherungsmutter	Selflocking nut	DIN985-NM16-8 Zn
11	305 6155	16	Scheibe	Washer	D30/17x6 St-37
12	305 9885	46	Federring	Spring ring	12 DIN127
13	309 6072	4	Spannhülse	Expansion bush	8x40-DIN1481 Zn
14	311 9565	4	Klappstift	Securing pin	4,5mm
15	313 1530	4	Bolzen mit Griff	Pin with grip	GB D15x41,8/60
16	317 3341	2	Einspannbuchse	Expansion bush	EG22/28x20-DIN1498
17	317 6658	4	Buchse	Bush	D16/22x22
18	319 9365	4	Flanschlager-Gehäuseeinheit	Bearing cpl.	RCJ 35 35x118x39,9
19	337 5003	23	Messer-lang	Knife	6x552,7/50 2xD8,5-80
20	422 6810	1	Tragrahmen	Frame	80 MSW D600-300 RE SM9
21	423 2180	2	Messerwalze	Knife roller	MSW D600-1390-12R-125
22	422 6812	1	Tragplatte	Support plate	12x130x440 2xD16 MSW D600
23	422 6813	4	Verstellplatte	Adjuster plate	8x464x775 13xD16 MSW D600
24	422 6814	1	Messerbalken	Cutter bar	70x2800 23M SM.9/300

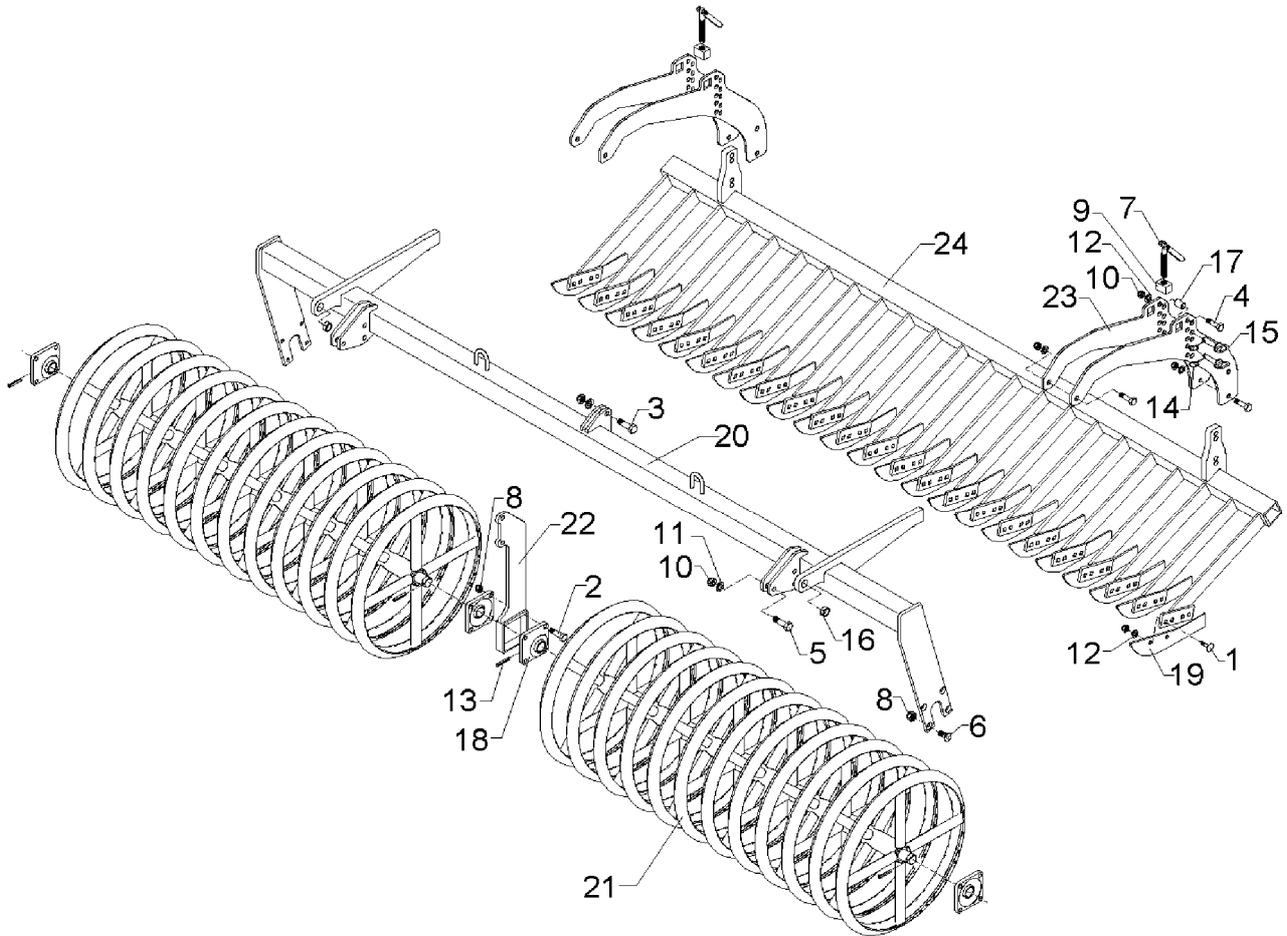

11.04

Pos.	Art.-Nr.	Stk.	Artikeltext / Description	Abmessung	
1	301 1805	48	Flachrundschaube mit Mutter	Bolt, cup square head	M12x30-10.9 MU
2	301 3407	4	Sechskantschraube DIN931-A	Bolt	M12x70-8.8
3	301 3779	2	Sechskantschraube spz.	Bolt	M16x60-10.9
4	301 3870	8	Sechskantschraube spz.	Bolt	M16x65-10.9
5	301 5360	6	Sechskantschraube spz.	Bolt	M16x70-12.9
6	301 6130	8	Senkschraube DIN7991-A	Countersunk bolt	M12x40-10.9
7	302 7933	2	Spindel kpl.	Screw cpl.	TR20x120-170
8	303 0934	12	Sicherungsmutter	Selflocking nut	DIN985-NM12-8 Zn
9	303 8644	2	Spindelmutter	Nut for screw	30x30x44 TR 20
10	303 0935	16	Sicherungsmutter	Selflocking nut	DIN985-NM16-8 Zn
11	305 6155	16	Scheibe	Washer	D30/17x6 St-37
12	305 9885	48	Federring	Spring ring	12 DIN127
13	309 6072	4	Spannhülse	Expansion bush	8x40-DIN1481 Zn
14	311 9565	4	Klappstift	Securing pin	4,5mm
15	313 1530	4	Bolzen mit Griff	Pin with grip	GB D15x41,8/60
16	317 3341	2	Einspannbuchse	Expansion bush	EG22/28x20-DIN1498
17	317 6658	4	Buchse	Bush	D16/22x22
18	319 9365	4	Flanschlager-Gehäuseeinheit	Bearing cpl.	RCJ 35 35x118x39,9
19	337 5003	24	Messer-lang	Knife	6x552,7/50 2xD8,5-80
20	422 6811	1	Tragrahmen	Frame	80 MSW D600-300 LI SM9
21	423 2180	2	Messerwalze	Knife roller	MSW D600-1390-12R-125
22	422 6812	1	Tragplatte	Support plate	12x130x440 2xD16 MSW D600
23	422 6813	4	Verstellplatte	Adjuster plate	8x464x775 13xD16 MSW D600
24	422 6823	1	Messerbalken	Cutter bar	70x2925 24M SM.9/600 LI

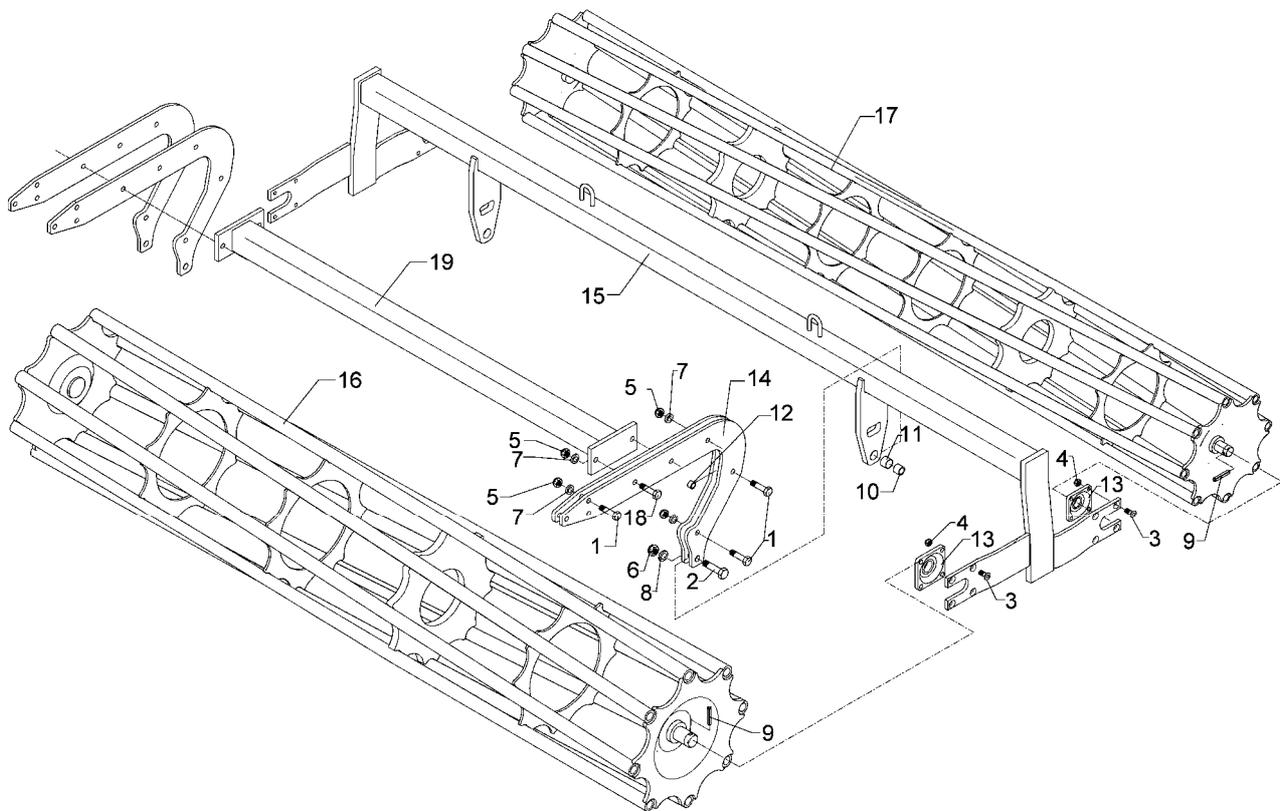

11.04

Pos.	Art.-Nr.	Stk.	Artikeltext / Description		Abmessung
1	301 5360	8	Sechskantschraube spz.	Bolt	M16x70-12.9
2	301 4602	2	Sechskantschraube spz.	Bolt	M20x75-8.8
3	301 6130	16	Senkschraube DIN7991-A	Countersunk bolt	M12x40-10.9
4	303 0934	16	Sicherungsmutter	Selflocking nut	DIN985-NM12-8 Zn
5	303 0935	12	Sicherungsmutter	Selflocking nut	DIN985-NM16-8 Zn
6	303 0936	2	Sicherungsmutter	Selflocking nut	DIN985-NM20-8 Zn
7	305 6155	10	Scheibe	Washer	D30/17x6 St-37
8	305 6164	2	Scheibe	Washer	D35/20,5x5
9	309 6072	4	Spannhülse	Expansion bush	8x40-DIN1481 Zn
10	317 3352	2	Einspannbuchse mit Preßsitz	Expansion bush	EG28/32x20
11	317 6657	8	Buchse	Bush	D20/28x22
12	317 6658	2	Buchse	Bush	D16/22x22
13	319 9365	4	Flanschlager-Gehäuseeinheit	Bearing cpl.	RCJ 35 35x118x39,9
14	417 8112	4	Platte	Plate	12x510x806 D540/400
15	422 6858	1	Tragrahmen	Frame	80x2910 D540/400-3.00 RE
16	423 0938	1	Rohrstabwalze	Tube bar roller	D540x2954 RE 3.00
17	423 0963	1	Rohrstabwalze	Tube bar roller	D400x2954-V LI 3.00
18	301 3959	4	Sechskantschraube DIN931-A	Bolt	M16x85-8.8
19	422 6639	1	Stabilisator	Stabilizer	80x1654 D540/400-3.00

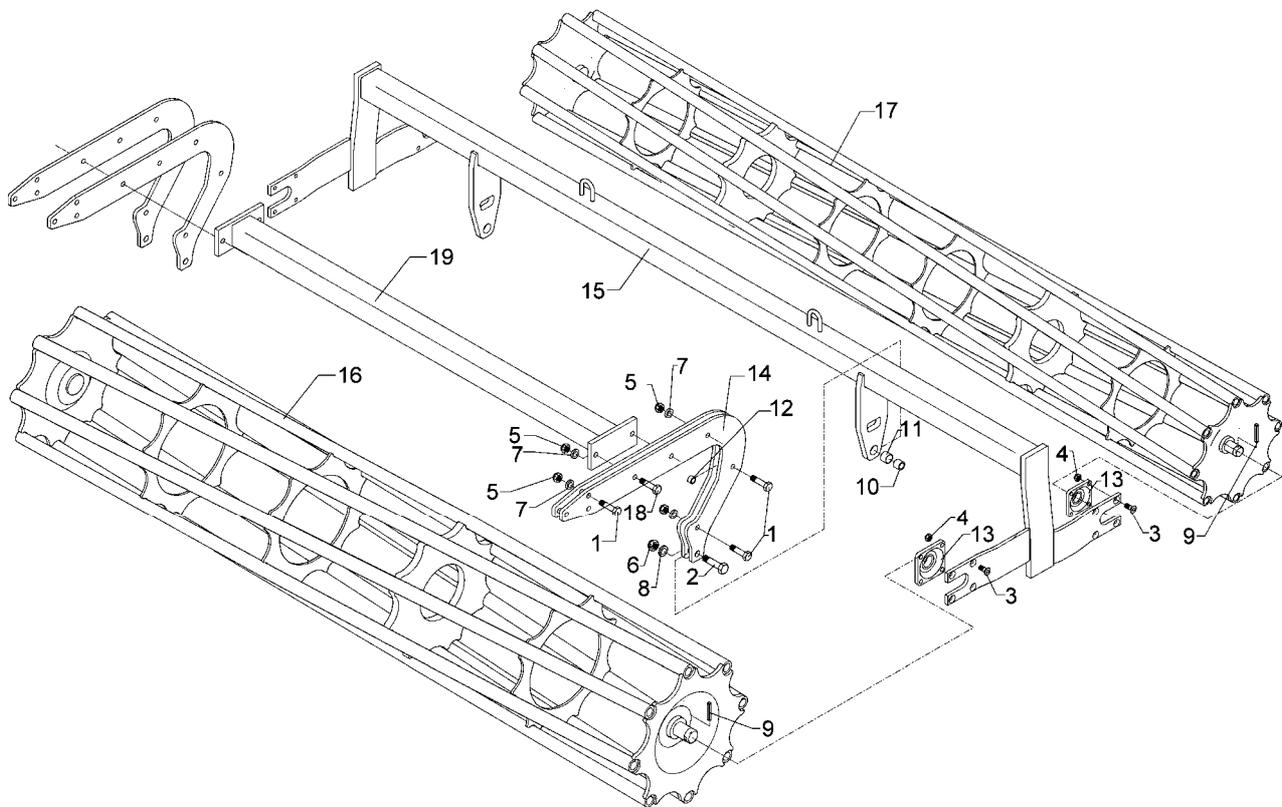

11.04

Pos.	Art.-Nr.	Stk.	Artikeltext / Description		Abmessung
1	301 5360	8	Sechskantschraube spz.	Bolt	M16x70-12.9
2	301 4602	2	Sechskantschraube spz.	Bolt	M20x75-8.8
3	301 6130	16	Senkschraube DIN7991-A	Countersunk bolt	M12x40-10.9
4	303 0934	16	Sicherungsmutter	Selflocking nut	DIN985-NM12-8 Zn
5	303 0935	12	Sicherungsmutter	Selflocking nut	DIN985-NM16-8 Zn
6	303 0936	2	Sicherungsmutter	Selflocking nut	DIN985-NM20-8 Zn
7	305 6155	10	Scheibe	Washer	D30/17x6 St-37
8	305 6164	2	Scheibe	Washer	D35/20,5x5
9	309 6072	4	Spannhülse	Expansion bush	8x40-DIN1481 Zn
10	317 3352	2	Einspannbuchse mit Preßsitz	Expansion bush	EG28/32x20
11	317 6657	8	Buchse	Bush	D20/28x22
12	317 6658	2	Buchse	Bush	D16/22x22
13	319 9365	4	Flanschlager-Gehäuseeinheit	Bearing cpl.	RCJ 35 35x118x39,9
14	417 8112	4	Platte	Plate	12x510x806 D540/400
15	422 6859	1	Tragrahmen	Frame	80x2910 D540/400-3.00 LI
16	423 0938	1	Rohrstabwalze	Tube bar roller	D540x2954 RE 3.00
17	423 0963	1	Rohrstabwalze	Tube bar roller	D400x2954-V LI 3.00
18	301 3959	4	Sechskantschraube DIN931-A	Bolt	M16x85-8.8
19	422 6639	1	Stabilisator	Stabilizer	80x1654 D540/400-3.00

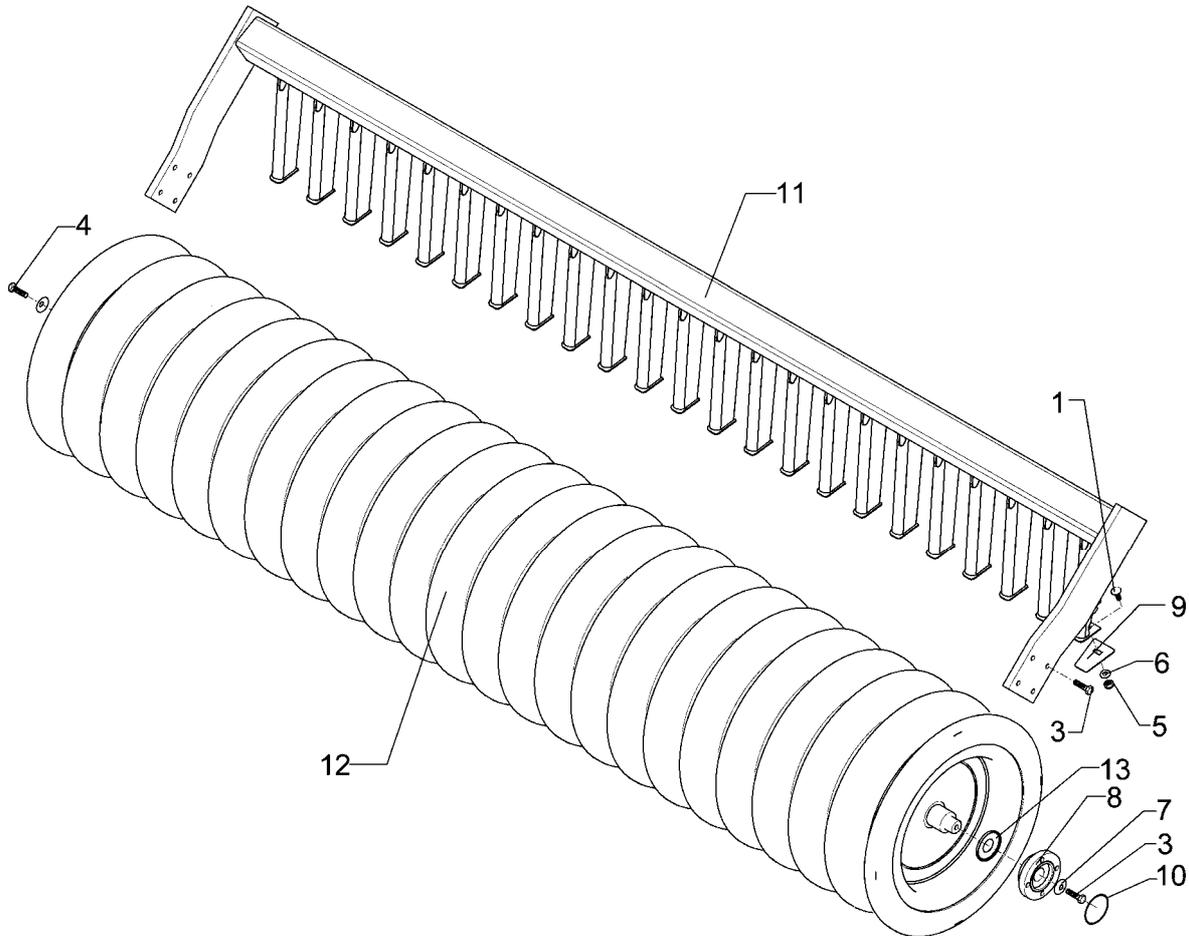

11.04

Pos.	Art.-Nr.	Stk.	Artikeltext / Description	Abmessung	
1	301 1701	23	Flachrundschaube DIN603	Bolt, cup square head	M10x20-4.6 Zn
3	301 3348	9	Sechskantschraube DIN933	Screw	M12x40-8.8
4	301 3325	1	Sechskantschraube DIN933-A	Screw	M12LHx30-8.8 Zn
5	303 0933	23	Sicherungsmutter	Selflocking nut	DIN985-NM10-8 Zn
6	305 6132	23	Scheibe	Washer	D11/25x2,5 Zn
7	329 6124	2	Tellerfeder	Cup spring	40x14,2x2 DIN2093
8	319 9372	2	Flanschlager-Gehäuseeinheit	Bearing cpl.	RCJ 35 35x118x39,9
9	349 2009	23	Abstreifer	Scraper	72x3x90 P
10	375 1278	2	O-Ring	O-ring	80x2
11	422 6873	1	Tragrahmen	Frame	90 GRW D590-300-125
12	523 6872	1	Gummiringwalze	Rubber ring roller	GRW D590-300-24R-125
13	323 0411	2	Schutzkappe	Cap	D80/d35 t=2x5,5

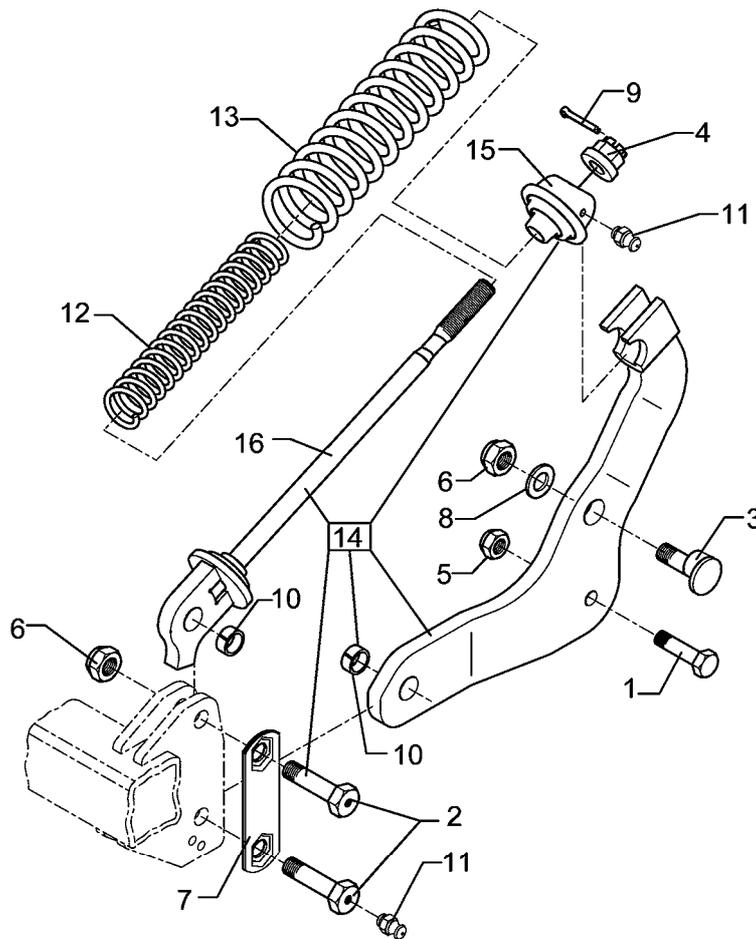

11.04

Pos.	Art.-Nr.	Stk.	Artikeltext / Description	Abmessung	
1	301 4600	1	Sechskantschraube DIN931-A	Bolt	M20x70x28-8.8
2	301 4637	2	Sechskantschraube-Schmierbohr.	Bolt	M24x85-8.8 MSB
3	301 8215	1	Exzentrerschraube	Eccentric bolt	M24x75/D35-24
4	303 0125	1	Kronenmutter mit Bund	Castle nut	M24/50
5	303 0936	1	Sicherungsmutter	Selflocking nut	DIN985-NM20-8 Zn
6	303 0937	3	Sicherungsmutter	Selflocking nut	DIN985-NM24-8 Zn
7	305 1328	1	Sicherungsblech	Locking plate	60x4x210 1x150-SW36
8	305 6253	2	Scheibe	Washer	B25 DIN125-St
9	311 7635	1	Splint	Peg	5x45 DIN94-St Zn
10	317 3412	2	Einspannbuchse mit Preßsitz	Expansion bush	EG24/32x22
11	323 6348	3	Schmiernippel	Grease nipple	AM10x1 DIN71412
12	329 8436	1	Druckfeder	Spring	21x90,5x400
13	329 8437	1	Druckfeder	Spring	13x55x380 Links
14	527 5687	1	Ersatz-Paket Überlastgrindel	Replacement package beam	427 5687
15	427 8167	1	Lager	Bearing	D100/25x80 Ü
16	427 8236	1	Führung	Guiding	Ü-80x22/100x22 A

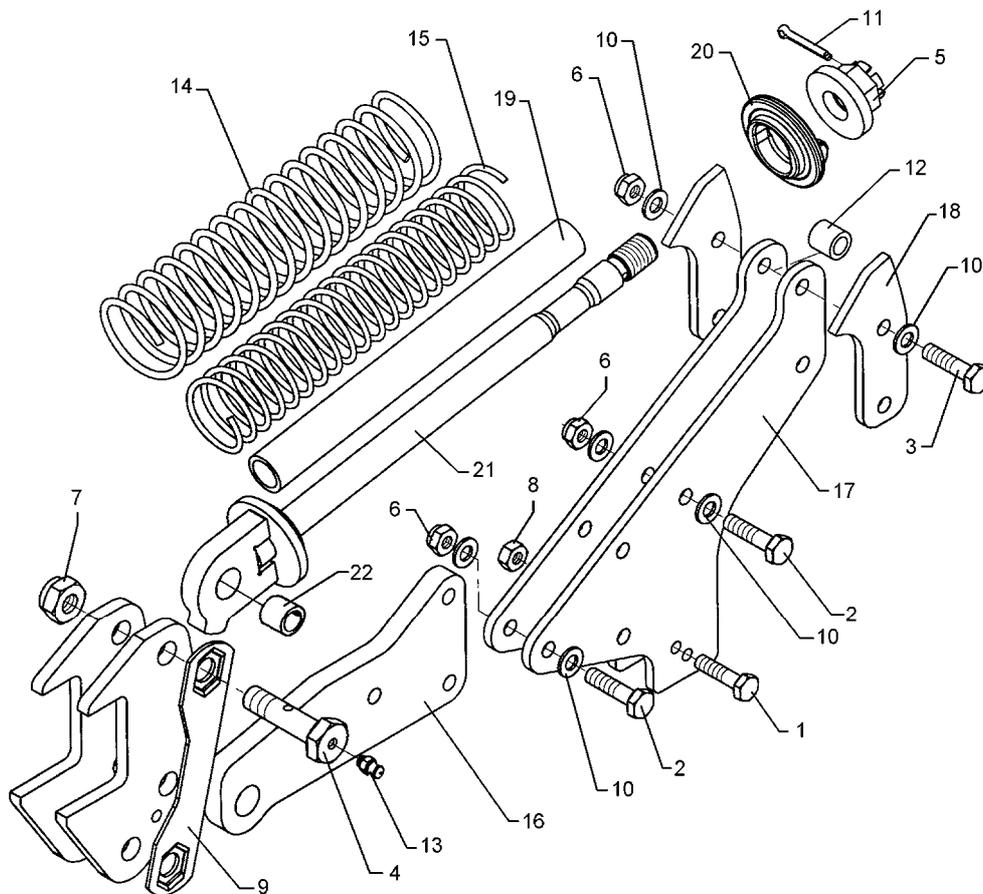

11.04

Pos.	Art.-Nr.	Stk.	Artikeltext / Description		Abmessung
1	301 3391	1	Sechskantschraube spz.	Bolt	M12x60-10.9
2	301 3870	4	Sechskantschraube spz.	Bolt	M16x65-10.9
3	301 5370	2	Sechskantschraube spz.	Bolt	M16x90-12.9
4	301 4637	2	Sechskantschraube-Schmierbohr.	Bolt	M24x85-8.8 MSB
5	303 0127	1	Kronenmutter mit Bund	Castle nut	M30/75
6	303 0935	6	Sicherungsmutter	Selflocking nut	DIN985-NM16-8 Zn
7	303 0937	2	Sicherungsmutter	Selflocking nut	DIN985-NM24-8 Zn
8	303 0972	1	Sechskantmutter	Nut	M12 DIN934-8
9	305 1329	1	Sicherungsblech	Locking plate	60x4x266 1x206,2-SW36 D30G
10	305 6163	8	Scheibe	Washer	D17/35x5
11	311 7649	1	Splint	Peg	6,3x63 DIN94-St Zn
12	317 6819	2	Röhrchen	Tube	26,9x4,5x22,5 +0,2
13	323 6348	2	Schmiernippel	Grease nipple	AM10x1 DIN71412
14	329 8436	1	Druckfeder	Spring	21x90,5x400
15	329 8437	1	Druckfeder	Spring	13x55x380 Links
16	427 5720	1	Grindel	Beam	157x22x327 3xD16 1xD32
17	427 5721	2	Grindelplatte	Plate for beam	394x10x394 6xD16 2xD12
18	427 5722	2	Gegenlager	Thrust bearing	10x188x94 2xD16
19	427 5723	1	Rohr Kunststoff	Tube, synthetic	D41,2/30,8x412
20	427 8168	1	Lager	Bearing	D100/20x42
21	427 8240	1	Führung	Guiding	D30G M30x580 D32
22	317 3412	1	Einspannbuchse mit Preßsitz	Expansion bush	EG24/32x22

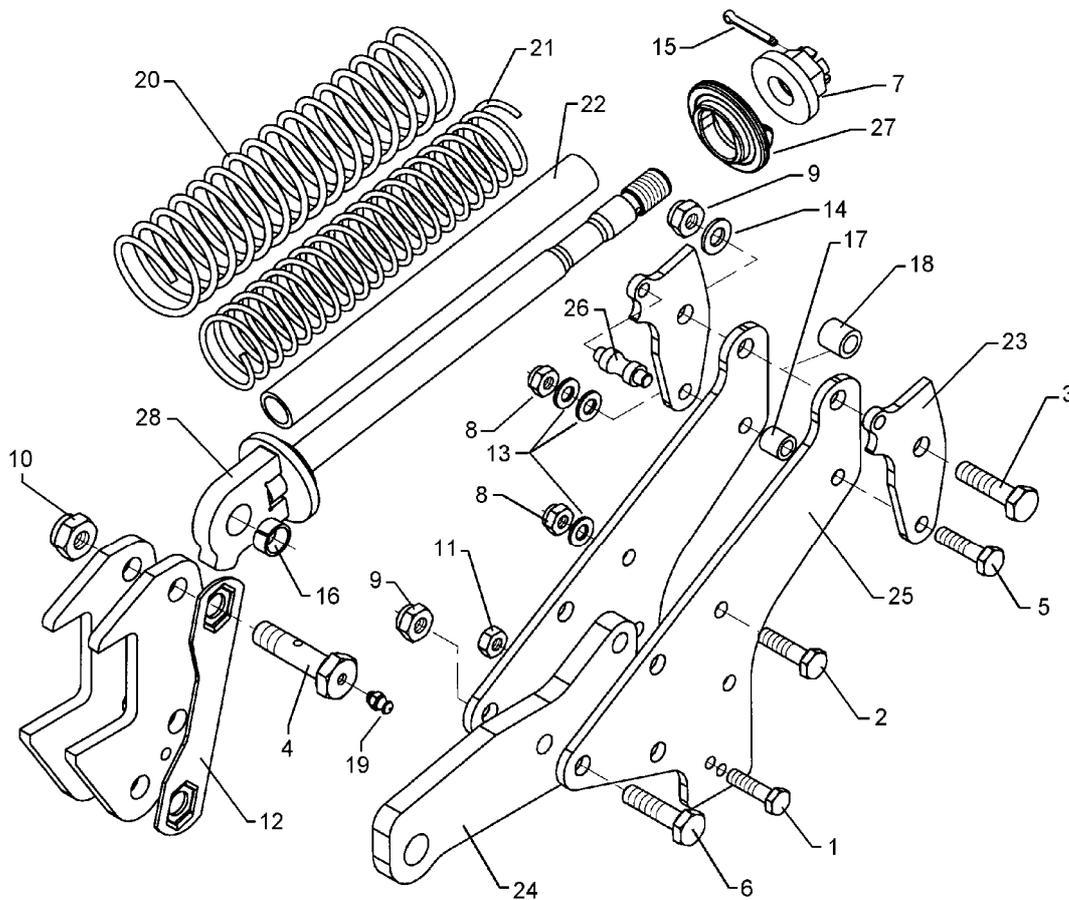

11.04

Pos.	Art.-Nr.	Stk.	Artikeltext / Description		Abmessung
1	301 3391	1	Sechskantschraube spz.	Bolt	M12x60-10.9
2	301 3870	1	Sechskantschraube spz.	Bolt	M16x65-10.9
3	301 4607	1	Sechskantschraube spz.	Bolt	M20x90-12.9
4	301 4637	2	Sechskantschraube-Schmierbohr.	Bolt	M24x85-8.8 MSB
5	301 5370	1	Sechskantschraube spz.	Bolt	M16x90-12.9
6	301 5390	3	Sechskantschraube spz.	Bolt	M20x65-12.9
7	303 0127	1	Kronenmutter mit Bund	Castle nut	M30/75
8	303 0935	2	Sicherungsmutter	Selflocking nut	DIN985-NM16-8 Zn
9	303 0936	4	Sicherungsmutter	Selflocking nut	DIN985-NM20-8 Zn
10	303 0937	2	Sicherungsmutter	Selflocking nut	DIN985-NM24-8 Zn
11	303 0972	1	Sechskantmutter	Nut	M12 DIN934-8
12	305 1329	1	Sicherungsblech	Locking plate	60x4x266 1x206,2-SW36 D30G
13	305 6163	3	Scheibe	Washer	D17/35x5
14	305 6186	1	Scheibe	Washer	D20,5/40x2,5
15	311 7649	1	Splint	Peg	6,3x63 DIN94-St Zn
16	317 3412	2	Einspannbuchse mit Preßsitz	Expansion bush	EG24/32x22
17	317 6819	1	Röhrchen	Tube	26,9x4,5x22,5 +0,2
18	317 6832	1	Röhrchen	Tube	30,0x4,5x22,5 +0,2
19	323 6348	2	Schmiernippel	Grease nipple	AM10x1 DIN71412
20	329 8436	1	Druckfeder	Spring	21x90,5x400
21	329 8437	1	Druckfeder	Spring	13x55x380 Links
22	427 5723	1	Rohr Kunststoff	Tube, synthetic	D41,2/30,8x412
23	427 5724	2	Gegenlager	Thrust bearing	10x188x94 1xD20 1xD16 1xD14
24	427 5725	1	Grindel	Beam	157x22x327 3xD20 1xD32
25	427 5726	2	Grindelplatte	Plate for beam	394x10x394 4xD20 3xD16 2xD12
26	427 5727	1	Rolle	Roller	D22/16x65 D14

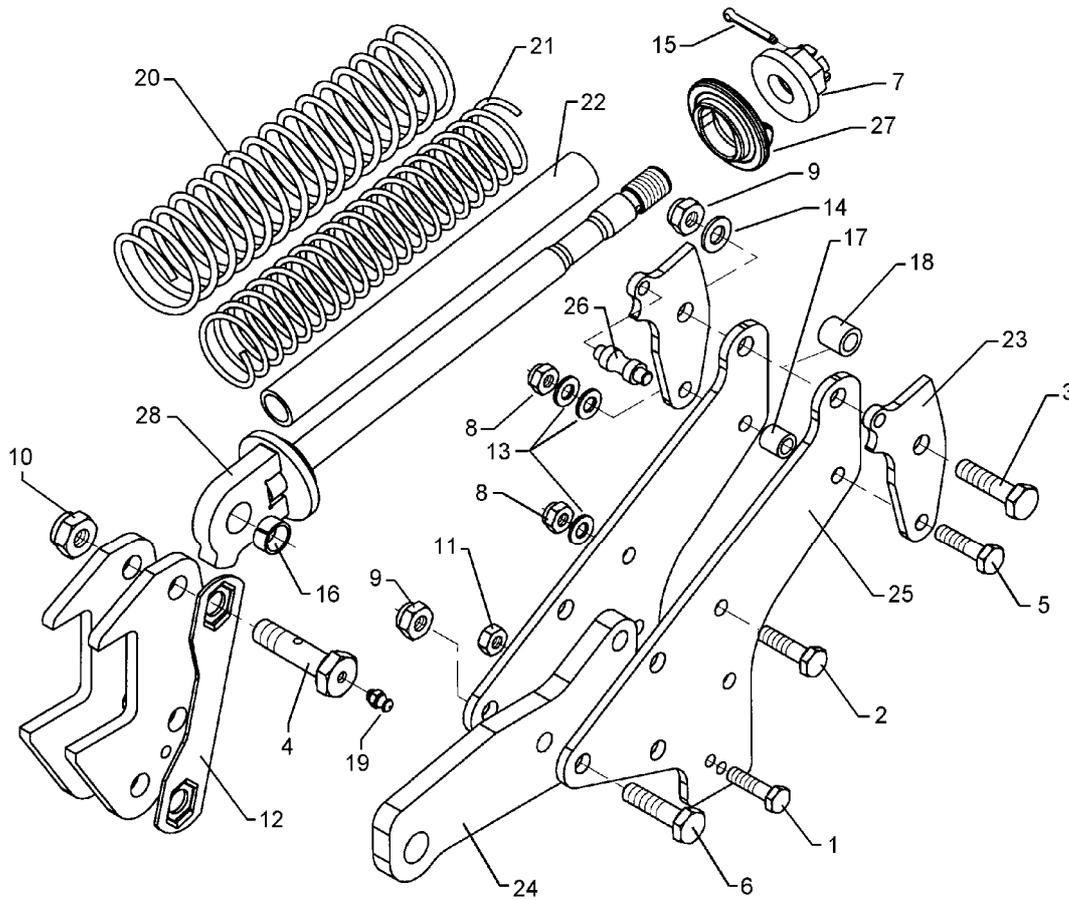

11.04

Pos.	Art.-Nr.	Stk.	Artikeltext / Description	Abmessung	
27	427 8168	1	Lager	Bearing	D100/20x42
28	427 8240	1	Führung	Guiding	D30G M30x580 D32

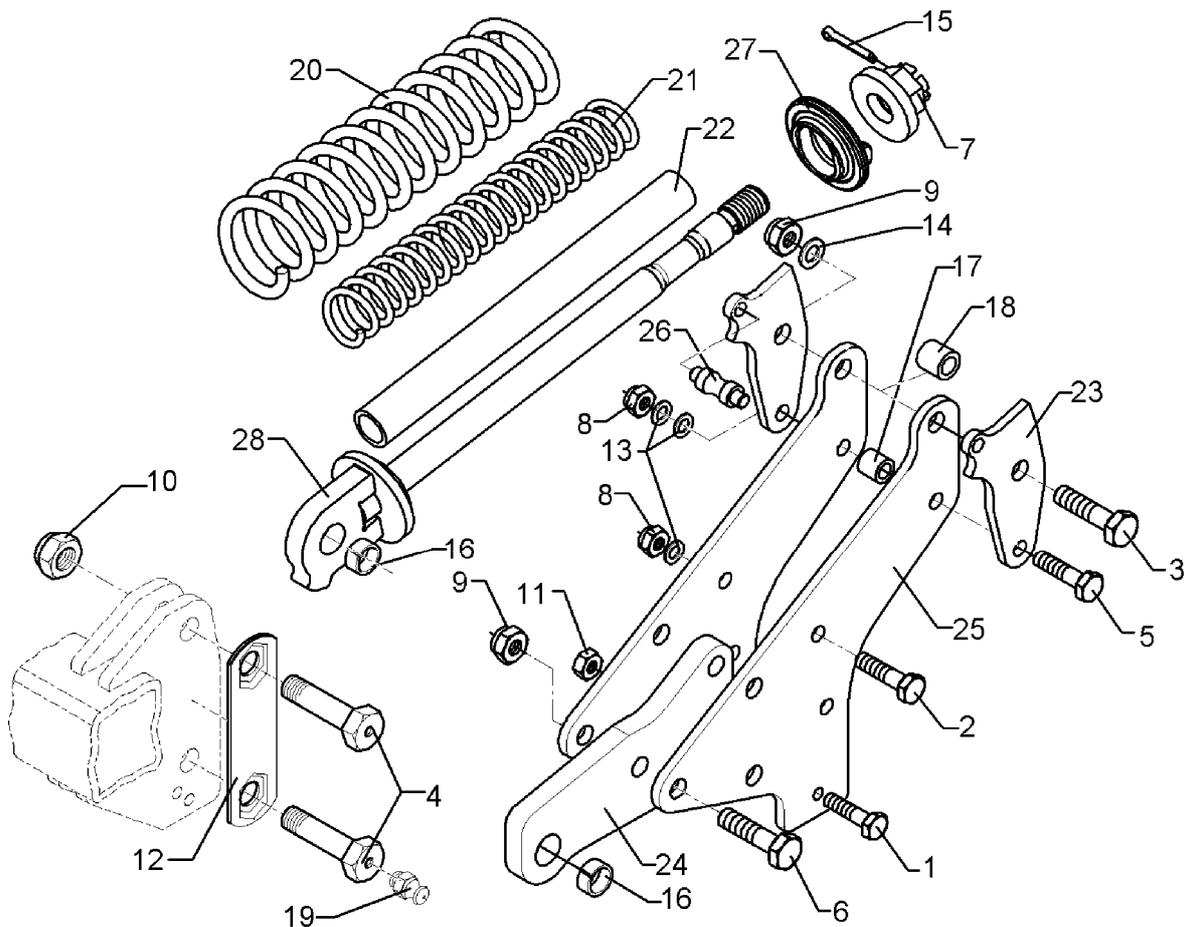

11.04

Pos.	Art.-Nr.	Stk.	Artikeltext / Description		Abmessung
1	301 3391	1	Sechskantschraube spz.	Bolt	M12x60-10.9
2	301 3870	1	Sechskantschraube spz.	Bolt	M16x65-10.9
3	301 4607	1	Sechskantschraube spz.	Bolt	M20x90-12.9
4	301 4637	2	Sechskantschraube-Schmierbohr.	Bolt	M24x85-8.8 MSB
5	301 5370	1	Sechskantschraube spz.	Bolt	M16x90-12.9
6	301 5390	3	Sechskantschraube spz.	Bolt	M20x65-12.9
7	303 0127	1	Kronenmutter mit Bund	Castle nut	M30/75
8	303 0935	2	Sicherungsmutter	Selflocking nut	DIN985-NM16-8 Zn
9	303 0936	4	Sicherungsmutter	Selflocking nut	DIN985-NM20-8 Zn
10	303 0937	2	Sicherungsmutter	Selflocking nut	DIN985-NM24-8 Zn
11	303 0972	1	Sechskantmutter	Nut	M12 DIN934-8
12	305 1328	1	Sicherungsblech	Locking plate	60x4x210 1x150-SW36
13	305 6163	3	Scheibe	Washer	D17/35x5
14	305 6186	1	Scheibe	Washer	D20,5/40x2,5
15	311 7649	1	Splint	Peg	6,3x63 DIN94-St Zn
16	317 3412	2	Einspannbuchse mit Preßsitz	Expansion bush	EG24/32x22
17	317 6819	1	Röhrchen	Tube	26,9x4,5x22,5 +0,2
18	317 6832	1	Röhrchen	Tube	30,0x4,5x22,5 +0,2
19	323 6348	2	Schmiernippel	Grease nipple	AM10x1 DIN71412
20	329 8436	1	Druckfeder	Spring	21x90,5x400
21	329 8437	1	Druckfeder	Spring	13x55x380 Links
22	427 5723	1	Rohr Kunststoff	Tube, synthetic	D41,2/30,8x412
23	427 5724	2	Gegenlager	Thrust bearing	10x188x94 1xD20 1xD16 1xD14
24	427 5729	1	Grindel	Beam	141x22x295 3xD20 1xD32
25	427 5726	2	Grindelplatte	Plate for beam	394x10x394 4xD20 3xD16 2xD12
26	427 5727	1	Rolle	Roller	D22/16x65 D14

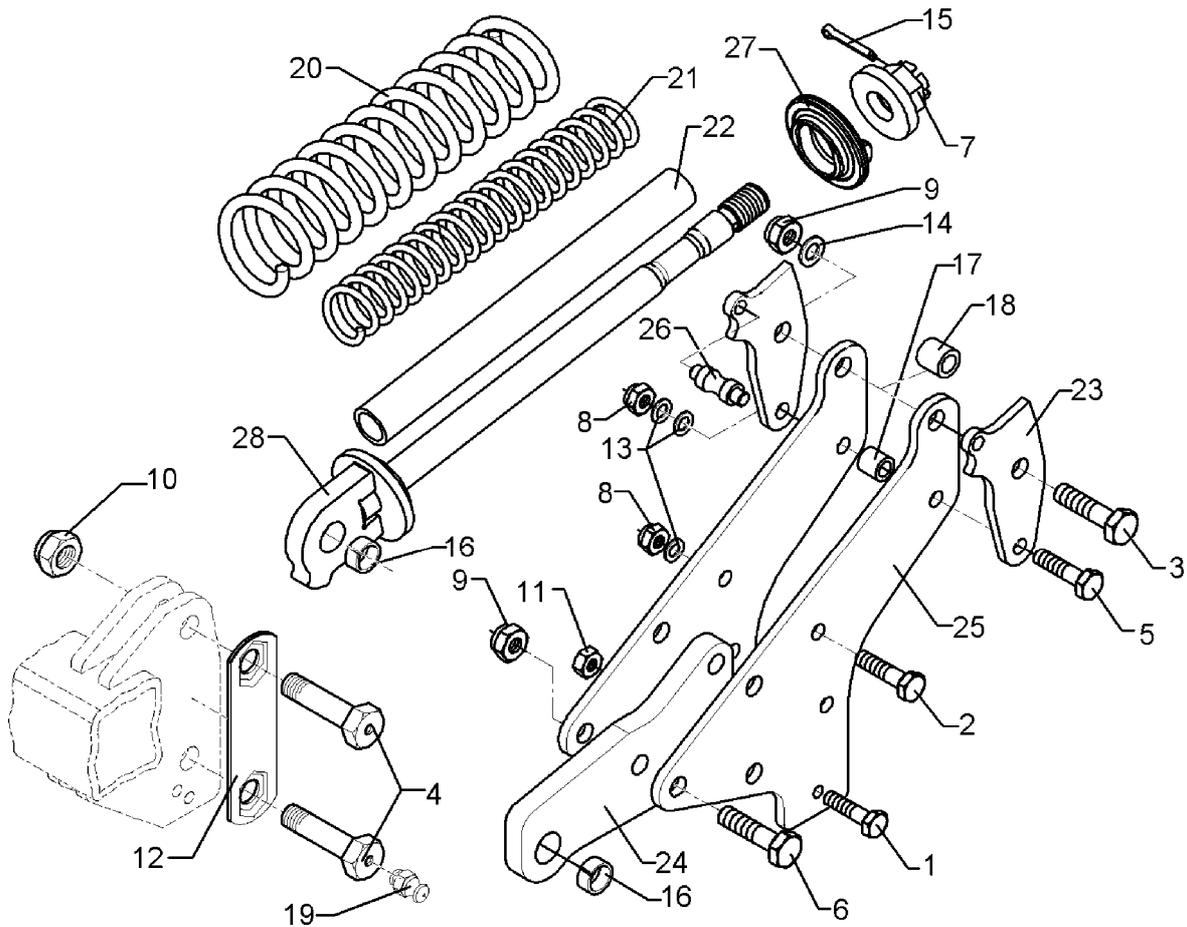

11.04

Pos.	Art.-Nr.	Stk.	Artikeltext / Description	Abmessung
27	427 8168	1	Lager	Bearing
28	427 8240	1	Führung	Guiding
				D100/20x42
				D30G M30x580 D32

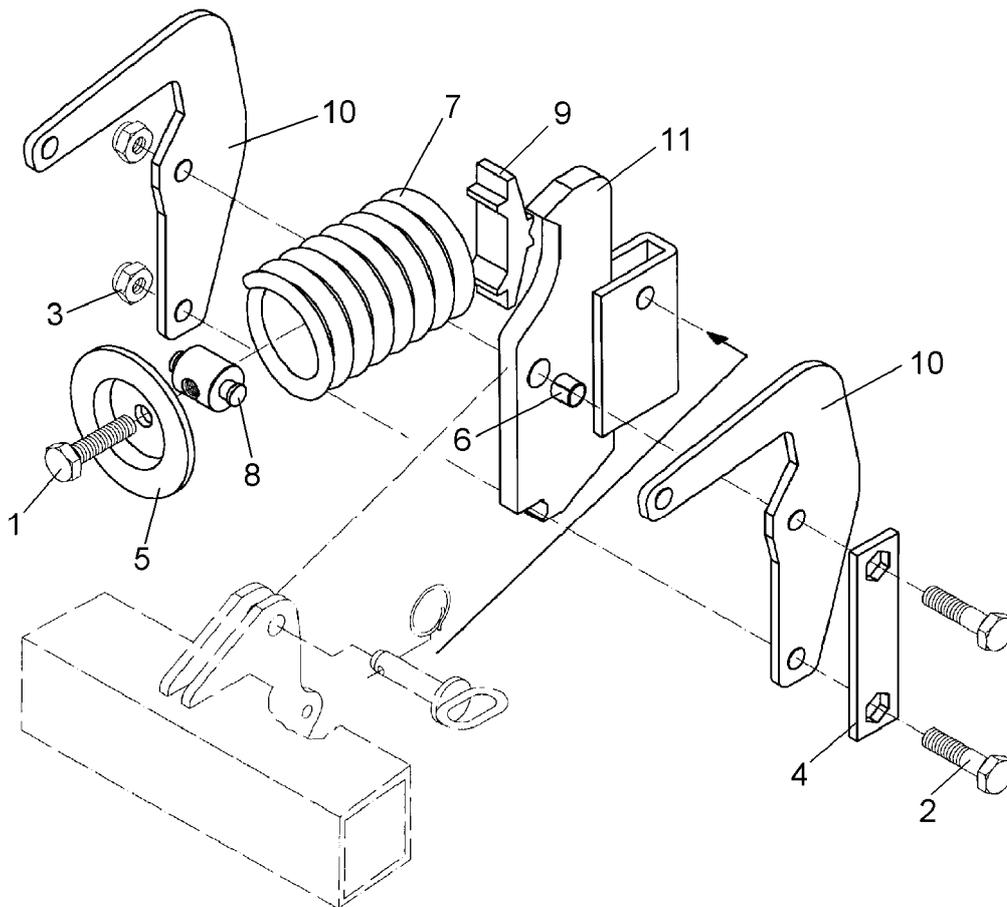

11.04

Pos.	Art.-Nr.	Stk.	Artikeltext / Description		Abmessung
1	301 5065	1	Sechskantschraube DIN933	Screw	M16x70-8.8
2	301 3920	2	Sechskantschraube spz.	Bolt	M16x80-8.8
3	303 0935	2	Sicherungsmutter	Selflocking nut	DIN985-NM16-8 Zn
4	305 1324	1	Sicherungsblech	Locking plate	40x4x160 1x120-SW24
5	305 6678	1	Scheibe gepreßt	Washer	D115/80x20x6
6	317 3336	1	Einspannbuchse	Expansion bush	EG16/22x18-DIN1498
7	329 8469	1	Druckfeder	Spring	14x97x202
8	427 5701	1	Gelenkmutter	Articulated nut	D35/16/14x59-M16
9	427 5702	1	Druckplatte	Pressure plate	30x110x36
10	427 5710	2	Federhalter	Flat steel	8x215x271
11	427 5712	1	Halmführung	Stalk guiding	50x18-18 D17/22

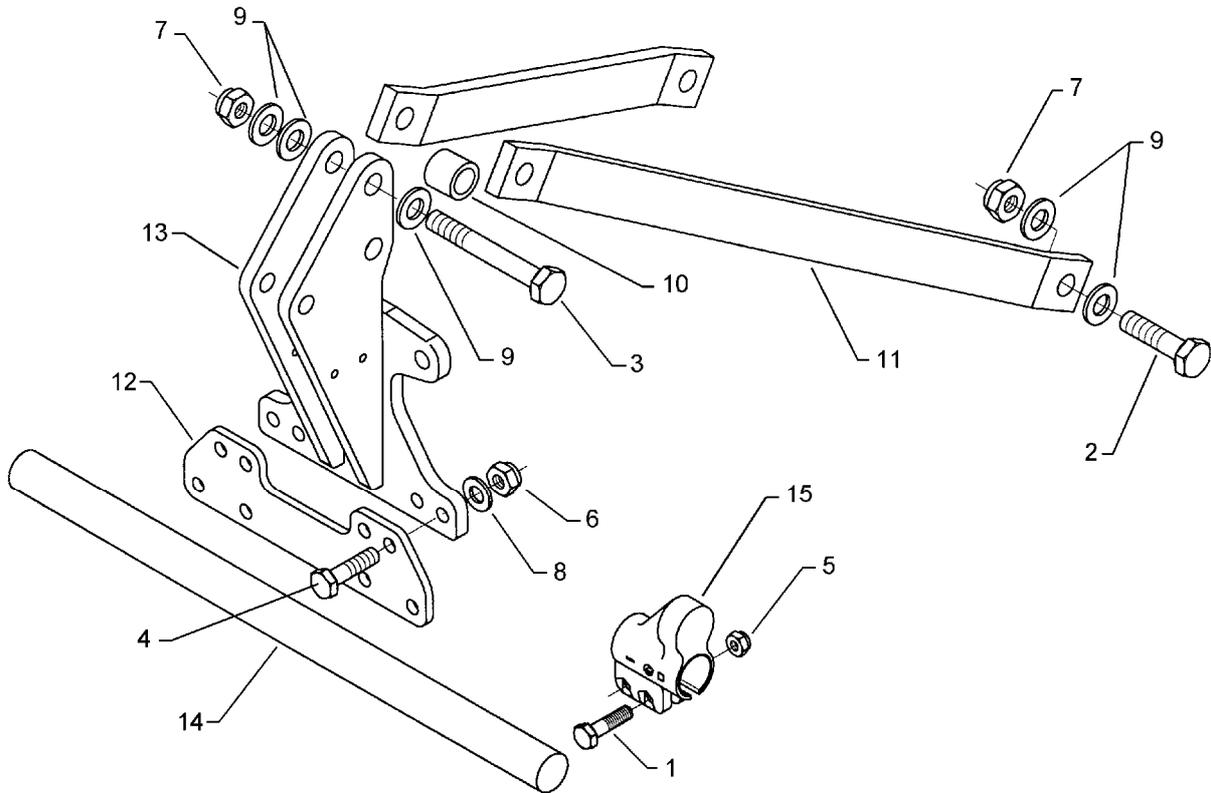

11.04

Pos.	Art.-Nr.	Stk.	Artikeltext / Description		Abmessung
1	301 3867	4	Sechskantschraube DIN931-A	Bolt	M16x65-8.8
2	301 4873	2	Sechskantschraube spz.	Bolt	M30x90-8.8
3	301 4896	1	Sechskantschraube spz.	Bolt	M30x190-8.8
4	301 5390	8	Sechskantschraube spz.	Bolt	M20x65-12.9
5	303 0935	4	Sicherungsmutter	Selflocking nut	DIN985-NM16-8 Zn
6	303 0936	8	Sicherungsmutter	Selflocking nut	DIN985-NM20-8 Zn
7	303 0938	3	Sicherungsmutter	Selflocking nut	DIN985-NM30-8 Zn
8	305 6164	12	Scheibe	Washer	D35/20,5x5
9	305 6326	7	Scheibe	Washer	60x31x6
10	317 6883	1	Röhrchen	Tube	51x8.8x48 +-0,5
11	440 3511	2	Strebe	Support	70x22x961
12	440 5224	1	Verbindungsplatte	Joint plate	12x430x125 8xD20
13	440 5230	1	Turm Smaragd 9 KA B	Headstock	-
14	461 7851	1	Welle	Shaft	D55x940
15	461 9874	2	Sperrstück	Stop	D55/68

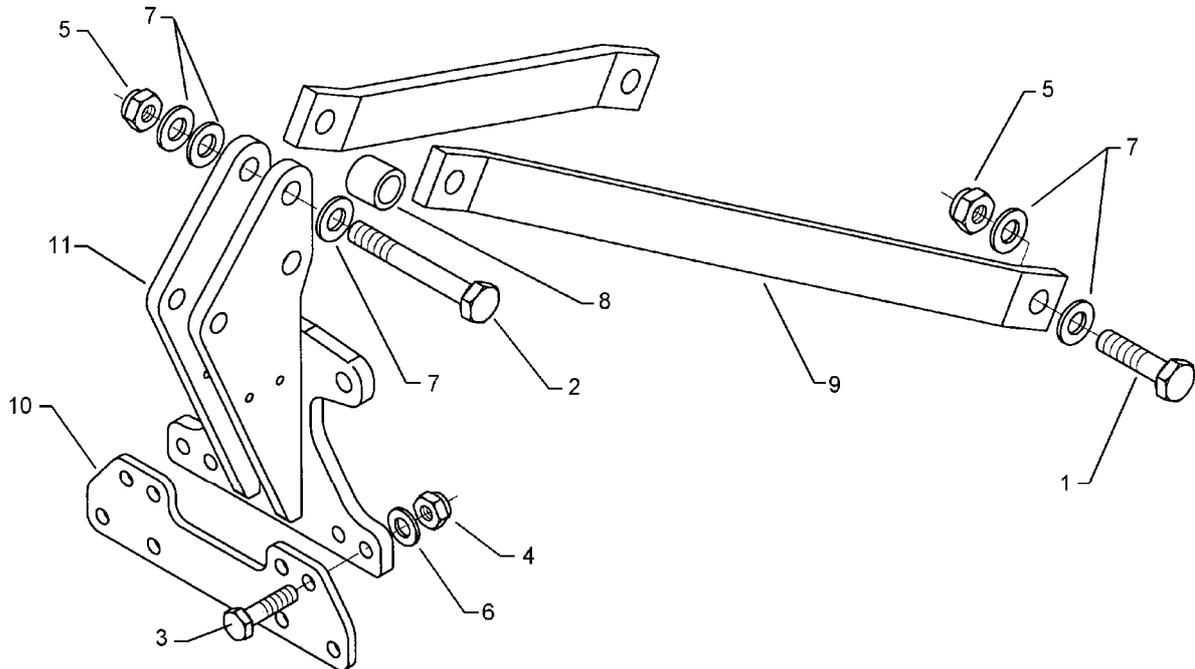

11.04

Pos.	Art.-Nr.	Stk.	Artikeltext / Description		Abmessung
1	301 4873	2	Sechskantschraube spz.	Bolt	M30x90-8.8
2	301 4896	1	Sechskantschraube spz.	Bolt	M30x190-8.8
3	301 5390	8	Sechskantschraube spz.	Bolt	M20x65-12.9
4	303 0936	8	Sicherungsmutter	Selflocking nut	DIN985-NM20-8 Zn
5	303 0938	3	Sicherungsmutter	Selflocking nut	DIN985-NM30-8 Zn
6	305 6164	12	Scheibe	Washer	D35/20,5x5
7	305 6326	7	Scheibe	Washer	60x31x6
8	317 6883	1	Röhrchen	Tube	51x8.8x48 +-0,5
9	440 3511	2	Strebe	Support	70x22x961
10	440 5224	1	Verbindungsplatte	Joint plate	12x430x125 8xD20
11	440 5230	1	Turm Smaragd 9 KA B	Headstock	-

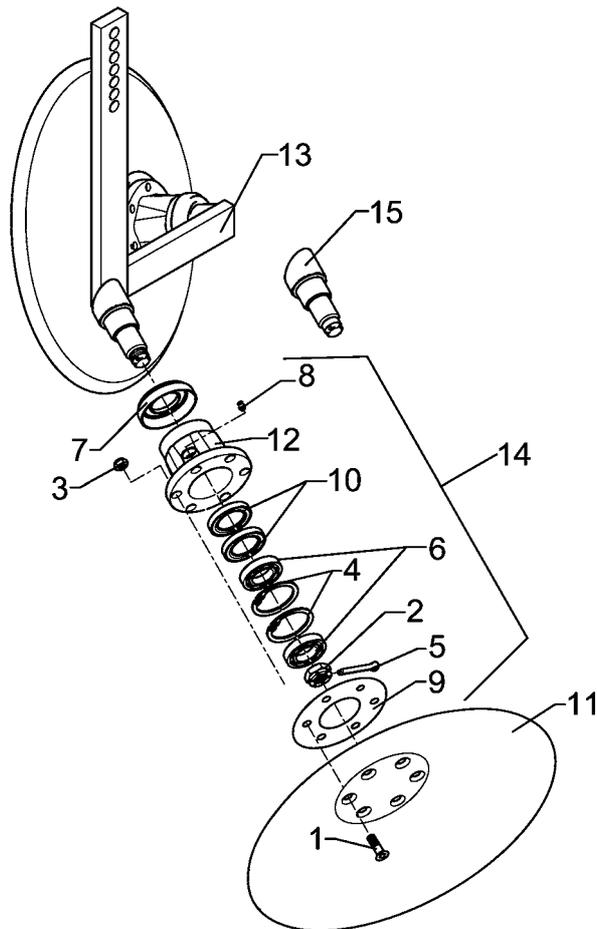

11.04

Pos.	Art.-Nr.	Stk.	Artikeltext / Description		Abmessung
1	301 6123	12	Senkschraube DIN7991-A	Countersunk bolt	M10x30-10.9
2	303 0193	1	Kronenmutter	Castle nut	DIN937-M24x1,5-22H
3	303 0933	12	Sicherungsmutter	Selflocking nut	DIN985-NM10-8 Zn
4	305 8924	2	Sicherungsring	Securing ring	62x2 DIN472
5	311 7613	1	Splint	Peg	3,2x40 DIN94-St Zn
6	319 9116	2	Kegelrollenlager	Bearing	30206.
7	323 0410	2	Schutzkappe	Cap	D81/77/40x18x2
8	323 6345	1	Schmiernippel	Grease nipple	LAM 6 DIN71412
9	323 7641	1	Dichtung	Seal	D120/65x1,6
10	323 8032	2	Wellendichtring	Oil seal	40x55x7 BA
11	349 0458	2	Hohlscheibe	Hollow disc	D450/100x5
12	447 8882	1	Nabe	Hub	668 A
13	457 2418	1	Scheibenträger	Disc carrier	50x18 2xD450-SM9
14	547 8883	2	Lagerung	Bearing	668A 2x30206
15	215 1636	1	Achse	Axle	D50/40/30x128

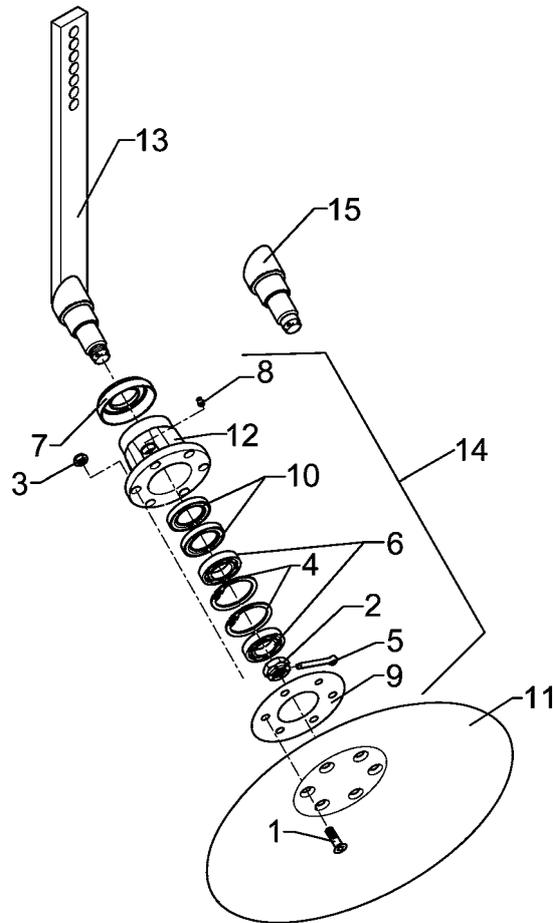

11.04

Pos.	Art.-Nr.	Stk.	Artikeltext / Description		Abmessung
1	301 6123	6	Senkschraube DIN7991-A	Countersunk bolt	M10x30-10.9
2	303 0193	1	Kronenmutter	Castle nut	DIN937-M24x1,5-22H
3	303 0933	6	Sicherungsmutter	Selflocking nut	DIN985-NM10-8 Zn
4	305 8924	2	Sicherungsring	Securing ring	62x2 DIN472
5	311 7613	1	Splint	Peg	3,2x40 DIN94-St Zn
6	319 9116	2	Kegelrollenlager	Bearing	30206.
7	323 0410	1	Schutzkappe	Cap	D81/77/40x18x2
8	323 6345	1	Schmiernippel	Grease nipple	LAM 6 DIN71412
9	323 7641	1	Dichtung	Seal	D120/65x1,6
10	323 8032	2	Wellendichtring	Oil seal	40x55x7 BA
11	349 0458	1	Hohlscheibe	Hollow disc	D450/100x5
12	447 8882	1	Nabe	Hub	668 A
13	457 2420	1	Scheibenträger	Disc carrier	RE 1xD450-SM9
14	547 8883	1	Lagerung	Bearing	668A 2x30206
15	215 1636	1	Achse	Axle	D50/40/30x128

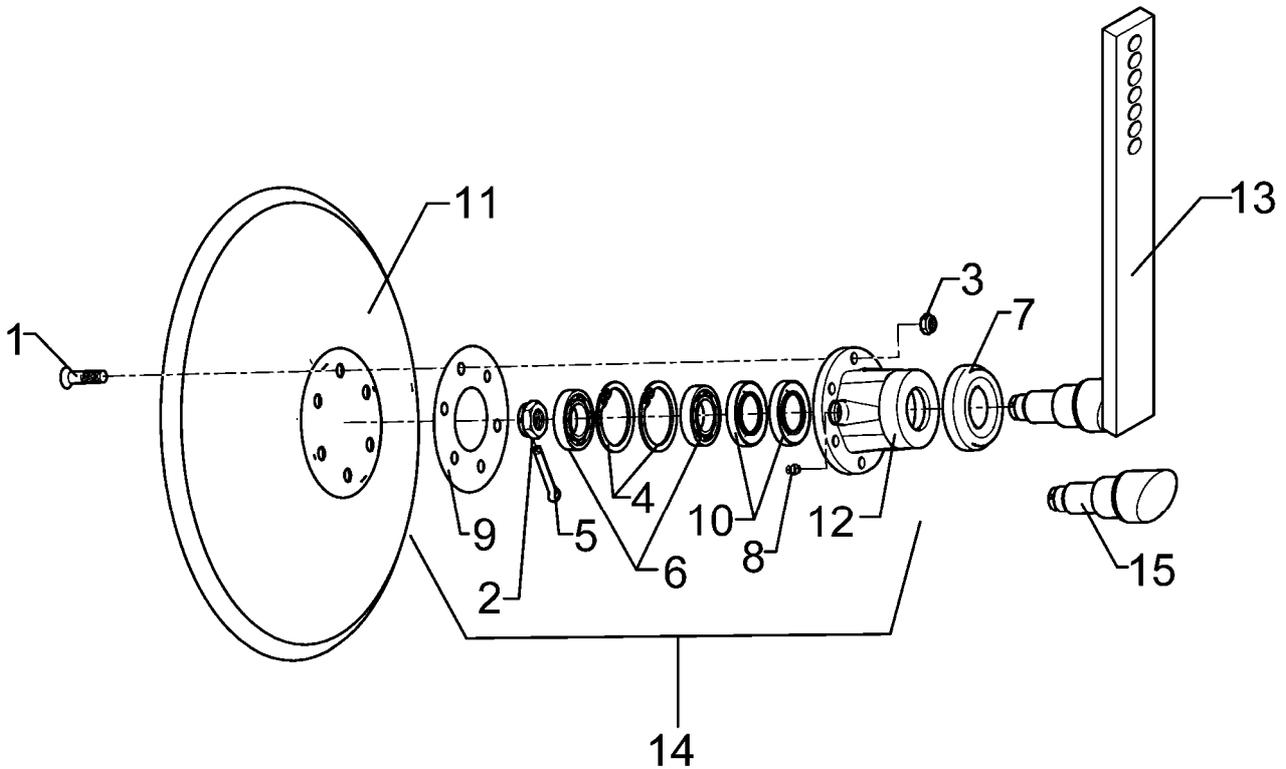

11.04

Pos.	Art.-Nr.	Stk.	Artikeltext / Description		Abmessung
1	301 6123	6	Senkschraube DIN7991-A	Countersunk bolt	M10x30-10.9
2	303 0193	1	Kronenmutter	Castle nut	DIN937-M24x1,5-22H
3	303 0933	6	Sicherungsmutter	Selflocking nut	DIN985-NM10-8 Zn
4	305 8924	2	Sicherungsring	Securing ring	62x2 DIN472
5	311 7613	1	Splint	Peg	3,2x40 DIN94-St Zn
6	319 9116	2	Kegelrollenlager	Bearing	30206.
7	323 0410	1	Schutzkappe	Cap	D81/77/40x18x2
8	323 6345	1	Schmiernippel	Grease nipple	LAM 6 DIN71412
9	323 7641	1	Dichtung	Seal	D120/65x1,6
10	323 8032	2	Wellendichtring	Oil seal	40x55x7 BA
11	349 0458	1	Hohlscheibe	Hollow disc	D450/100x5
12	447 8882	1	Nabe	Hub	668 A
13	457 2421	1	Scheibenträger	Disc carrier	LI 1xD450-SM9
14	547 8883	1	Lagerung	Bearing	668A 2x30206
15	215 1636	1	Achse	Axle	D50/40/30x128

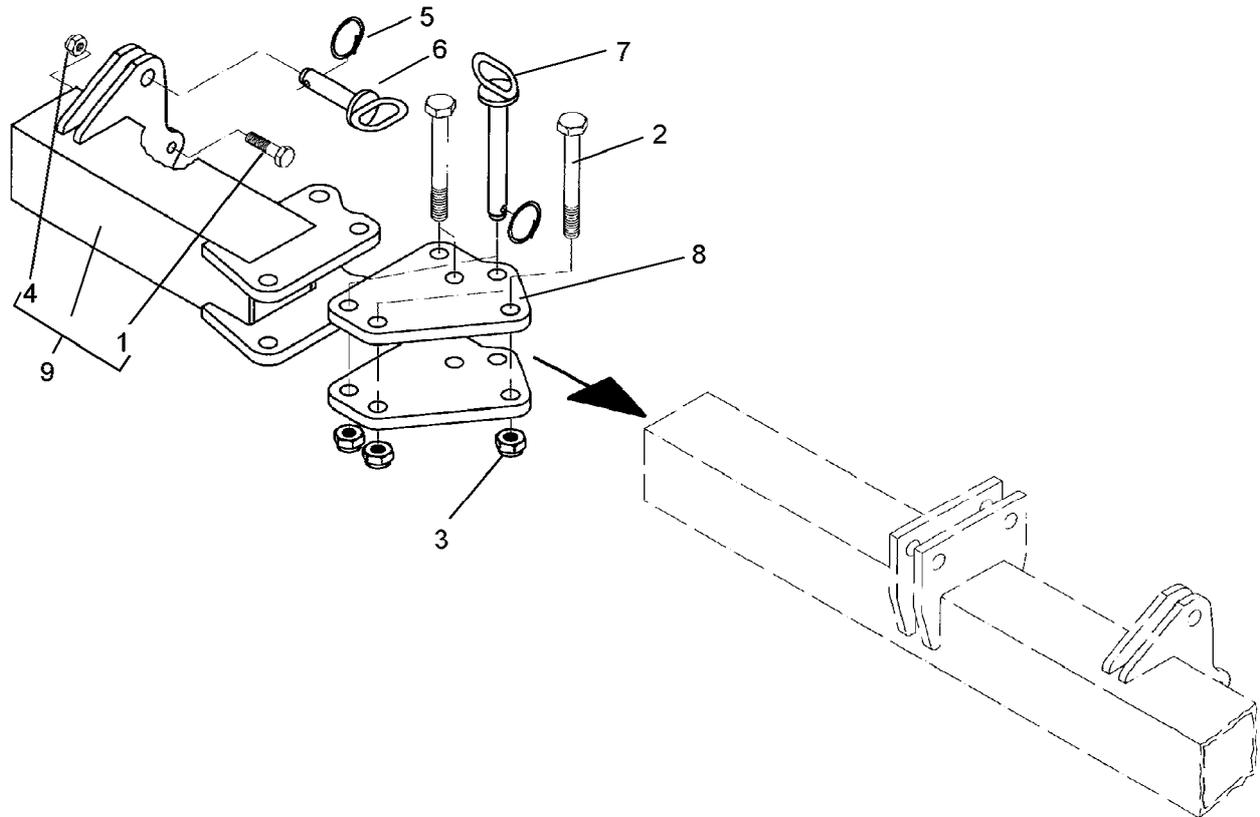

11.04

Pos.	Art.-Nr.	Stk.	Artikeltext / Description		Abmessung
1	301 3240	1	Sechskantschraube spz.	Bolt	M10x45-8.8
2	301 4038	4	Sechskantschraube DIN931-A	Bolt	M16x120-8.8
3	303 0935	4	Sicherungsmutter	Selflocking nut	DIN985-NM16-8 Zn
4	303 0970	1	Sechskantmutter	Nut	M10 DIN934-8
5	305 8551	2	Federsicherung	Securing clip	41x3
6	313 1530	1	Bolzen mit Griff	Pin with grip	GB D15x41,8/60
7	313 8715	1	Bolzen mit Griff	Pin with grip	GB D16x116,75/135-Zn
8	417 6307	2	Platte	Plate	142x162,2x12
9	417 6308	1	Seitenteil	Lateral part	80x80x348 SM9 RE

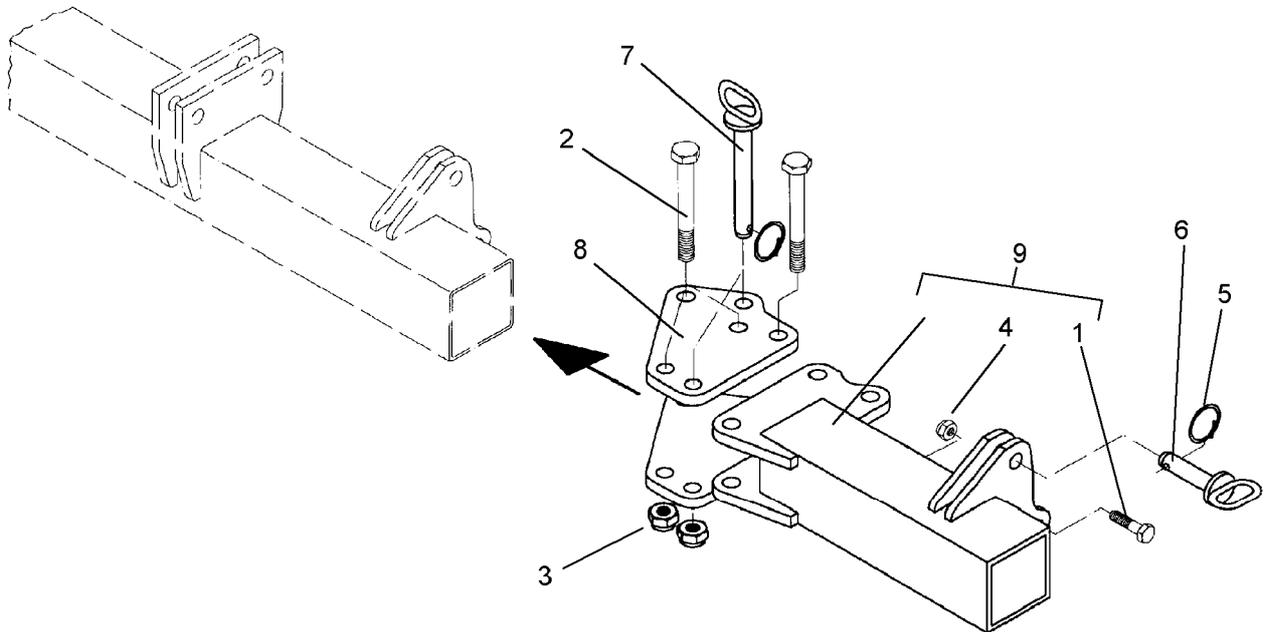

11.04

Pos.	Art.-Nr.	Stk.	Artikeltext / Description		Abmessung
1	301 3240	1	Sechskantschraube spz.	Bolt	M10x45-8.8
2	301 4038	4	Sechskantschraube DIN931-A	Bolt	M16x120-8.8
3	303 0935	4	Sicherungsmutter	Selflocking nut	DIN985-NM16-8 Zn
4	303 0970	1	Sechskantmutter	Nut	M10 DIN934-8
5	305 8551	2	Federsicherung	Securing clip	41x3
6	313 1530	1	Bolzen mit Griff	Pin with grip	GB D15x41,8/60
7	313 8715	1	Bolzen mit Griff	Pin with grip	GB D16x116,75/135-Zn
8	417 6307	2	Platte	Plate	142x162,2x12
9	417 6309	1	Seitenteil	Lateral part	80x80x348 SM9 LI

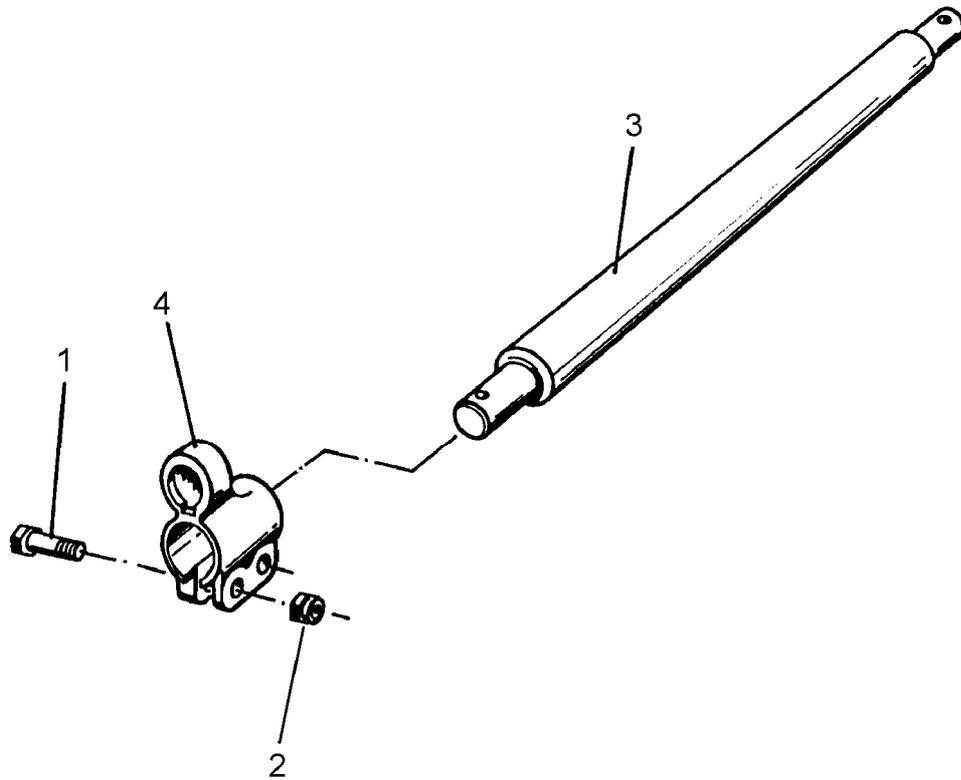

11.04

Pos.	Art.-Nr.	Stk.	Artikeltext / Description	Abmessung	
1	301 3867	4	Sechskantschraube DIN931-A	Bolt	M16x65-8.8
2	303 0935	4	Sicherungsmutter	Selflocking nut	DIN985-NM16-8 Zn
3	461 7923	1	Schienenwelle	Drawbar	D55 L2 Z3
4	461 9874	2	Sperrstück	Stop	D55/68

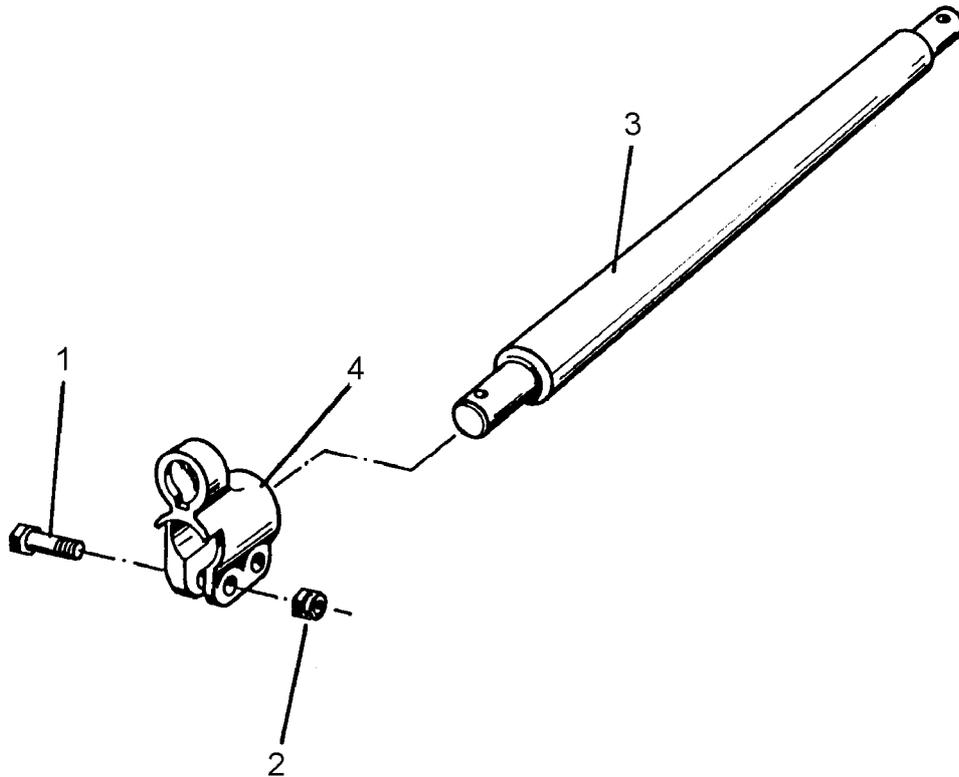

11.04

Pos.	Art.-Nr.	Stk.	Artikeltext / Description		Abmessung
1	301 3867	4	Sechskantschraube DIN931-A	Bolt	M16x65-8.8
2	303 0935	4	Sicherungsmutter	Selflocking nut	DIN985-NM16-8 Zn
3	461 7925	1	Schienenwelle	Drawbar	D68 L3 Z3
4	461 9875	2	Sperrstück	Stop	D68

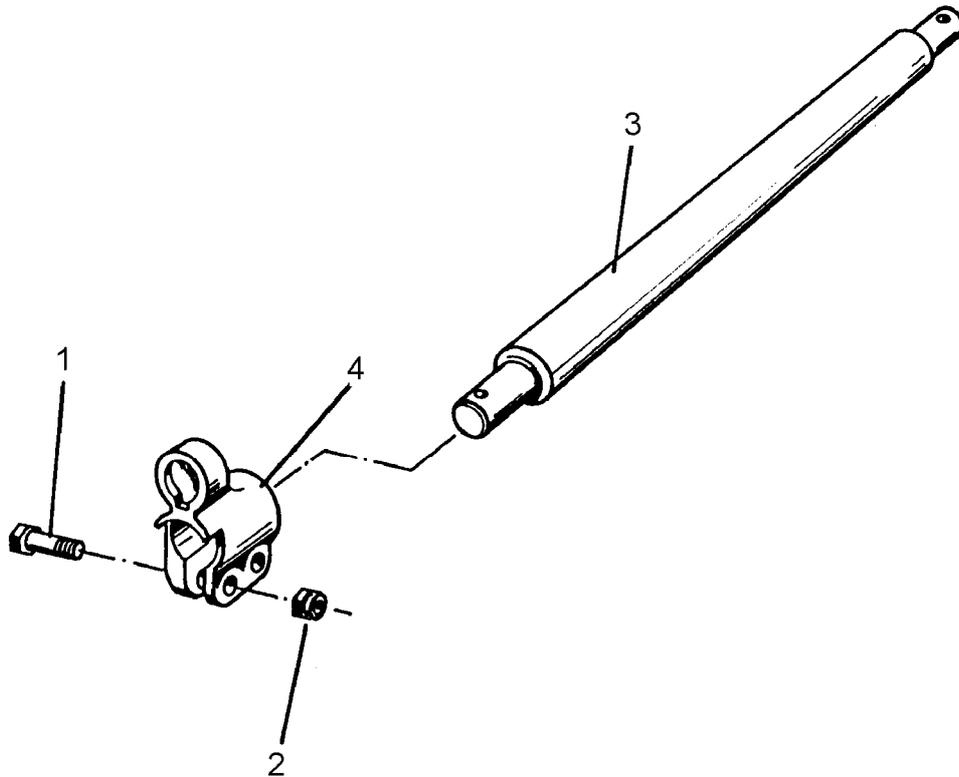

11.04

Pos.	Art.-Nr.	Stk.	Artikeltext / Description		Abmessung
1	301 3867	4	Sechskantschraube DIN931-A	Bolt	M16x65-8.8
2	303 0935	4	Sicherungsmutter	Selflocking nut	DIN985-NM16-8 Zn
3	461 7928	1	Schienenwelle	Drawbar	D68 L1100 Z58 K700
4	461 9875	2	Sperrstück	Stop	D68

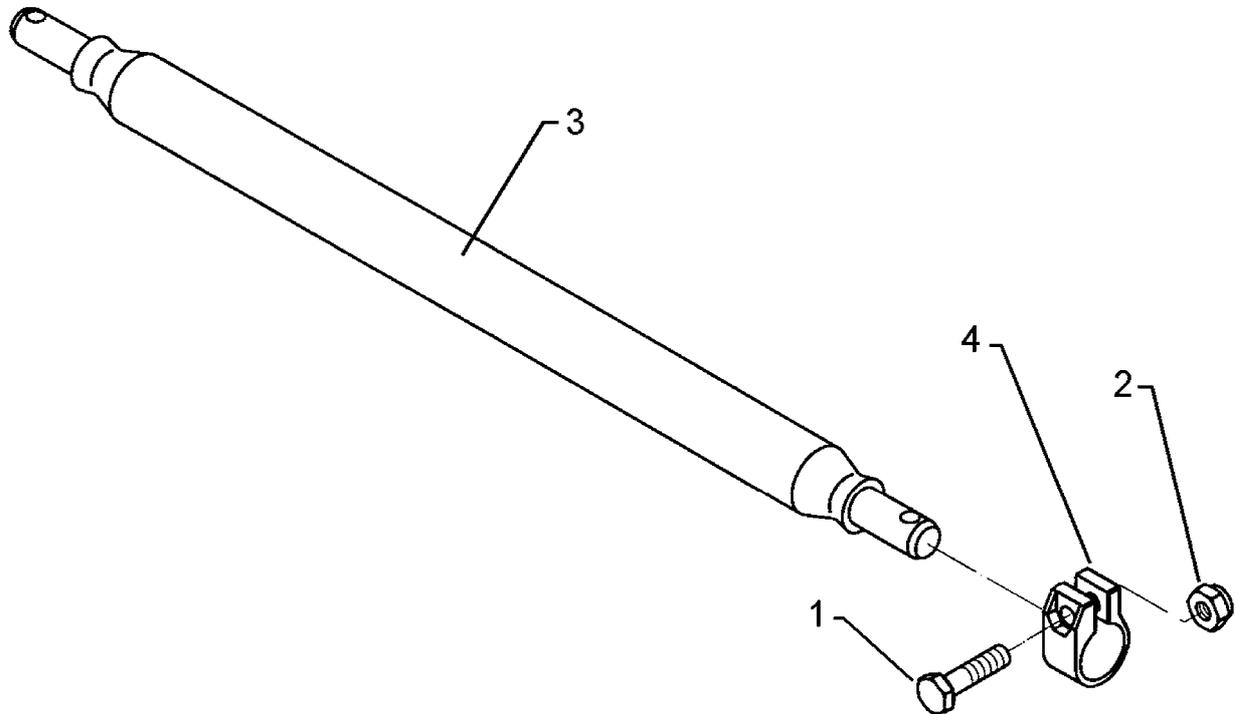

11.04

Pos.	Art.-Nr.	Stk.	Artikeltext / Description	Abmessung	
1	301 3867	2	Sechskantschraube DIN931-A	Bolt	M16x65-8.8
2	303 0935	2	Sicherungsmutter	Selflocking nut	DIN985-NM16-8 Zn
3	317 6961	2	Buchse	Bush	D69/56x65-3
4	461 7917	1	Schienenwelle	Drawbar	D55 L2 Z2
5	461 9868	2	Klemme	Clamp	D68x40

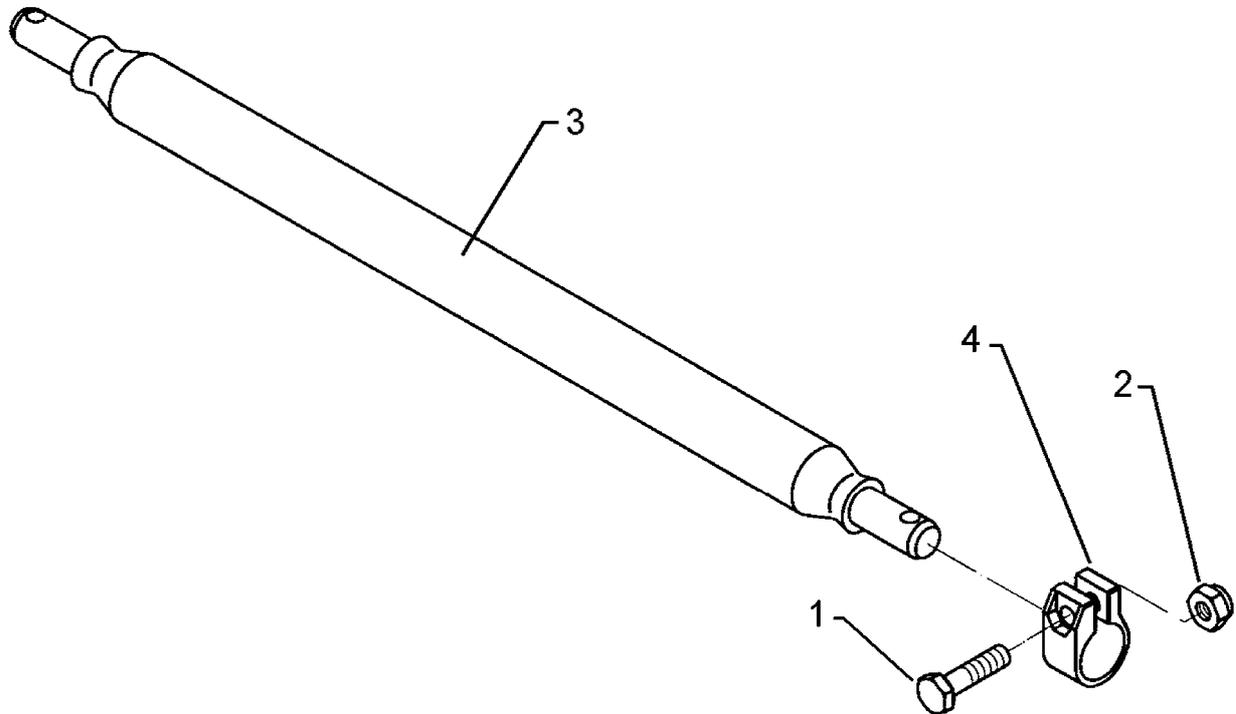

11.04

Pos.	Art.-Nr.	Stk.	Artikeltext / Description	Abmessung	
1	301 3867	2	Sechskantschraube DIN931-A	Bolt	M16x65-8.8
2	303 0935	2	Sicherungsmutter	Selflocking nut	DIN985-NM16-8 Zn
3	317 6961	2	Buchse	Bush	D69/56x65-3
4	461 7924	1	Schienenwelle	Drawbar	D55 L3 Z2
5	461 9868	2	Klemme	Clamp	D68x40

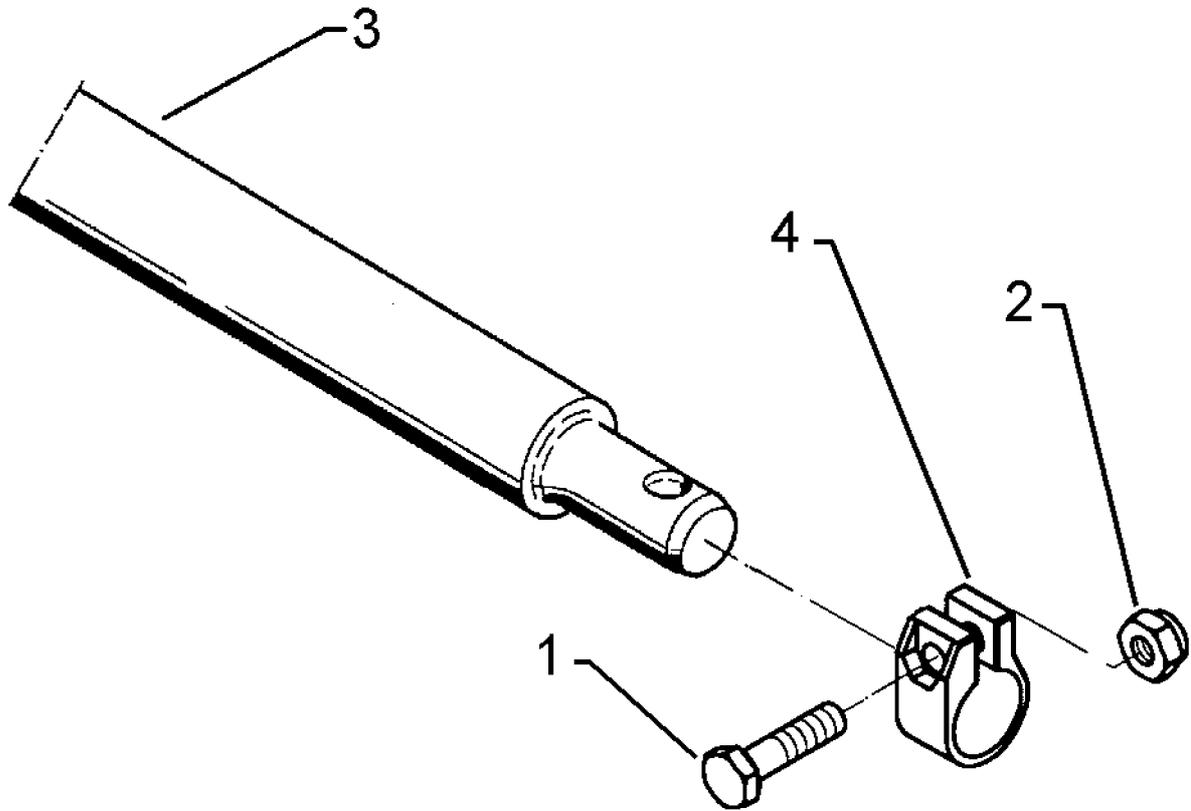

11.04

Pos.	Art.-Nr.	Stk.	Artikeltext / Description		Abmessung
1	301 3867	2	Sechskantschraube DIN931-A	Bolt	M16x65-8.8
2	303 0935	2	Sicherungsmutter	Selflocking nut	DIN985-NM16-8 Zn
3	461 7905	1	Schienenwelle	Drawbar	D68 L2 Z3 980lg.
4	461 9868	2	Klemme	Clamp	D68x40

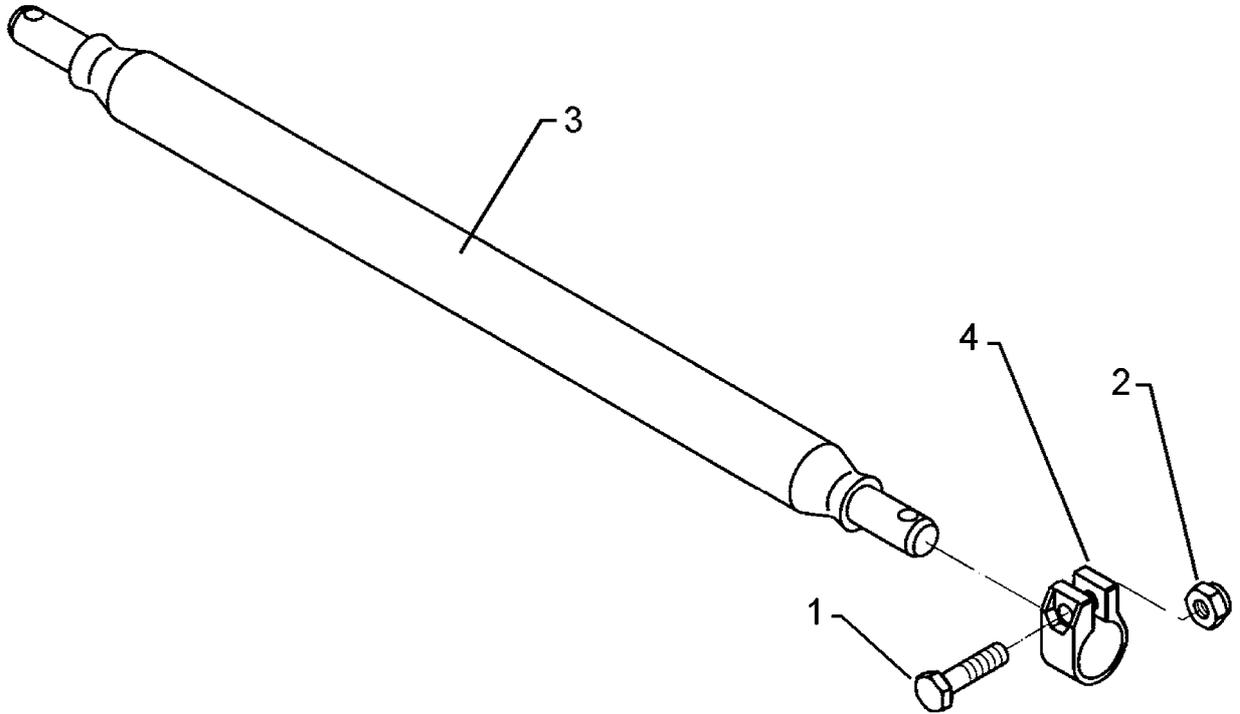

11.04

Pos.	Art.-Nr.	Stk.	Artikeltext / Description	Abmessung
1	301 3867	2	Sechskantschraube DIN931-A	Bolt
2	303 0935	2	Sicherungsmutter	Selflocking nut
3	461 7925	1	Schienenwelle	Drawbar
4	461 9868	2	Klemme	Clamp
				M16x65-8.8
				DIN985-NM16-8 Zn
				D68 L3 Z3
				D68x40

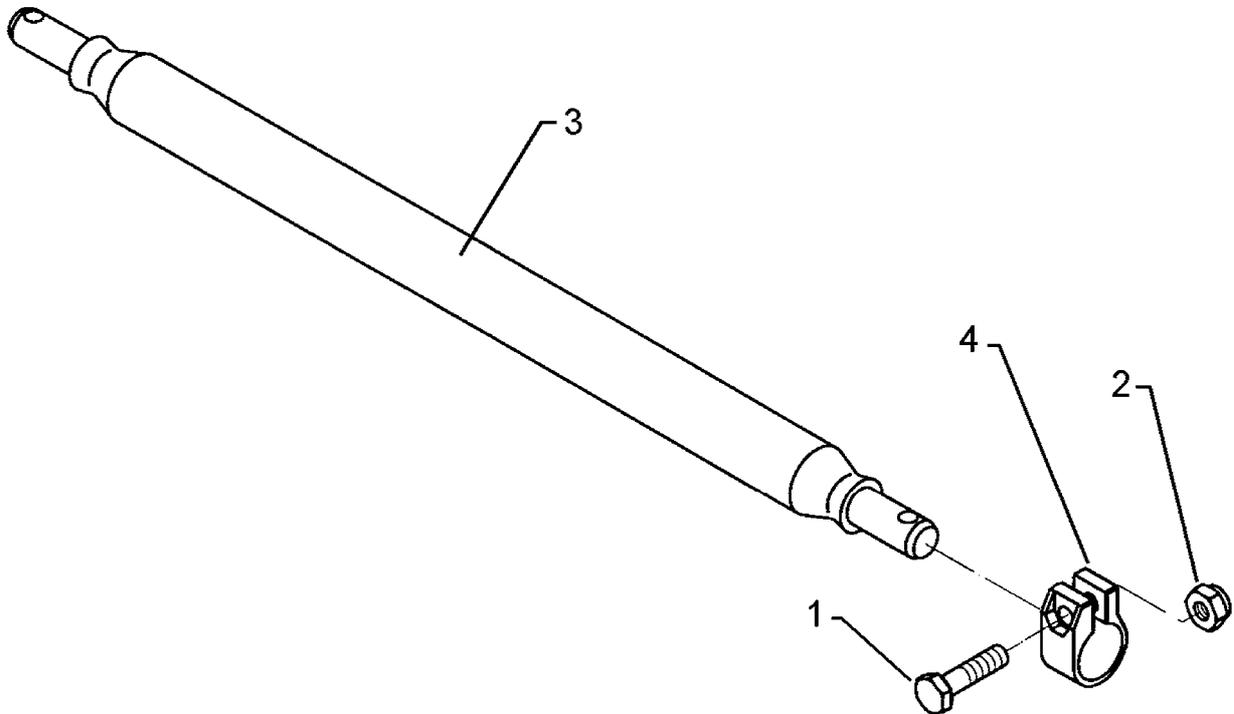

11.04

Pos.	Art.-Nr.	Stk.	Artikeltext / Description	Abmessung	
1	301 3867	2	Sechskantschraube DIN931-A	Bolt	M16x65-8.8
2	303 0935	2	Sicherungsmutter	Selflocking nut	DIN985-NM16-8 Zn
3	461 7928	1	Schienenwelle	Drawbar	D68 L1100 Z58 K700
4	461 9868	2	Klemme	Clamp	D68x40

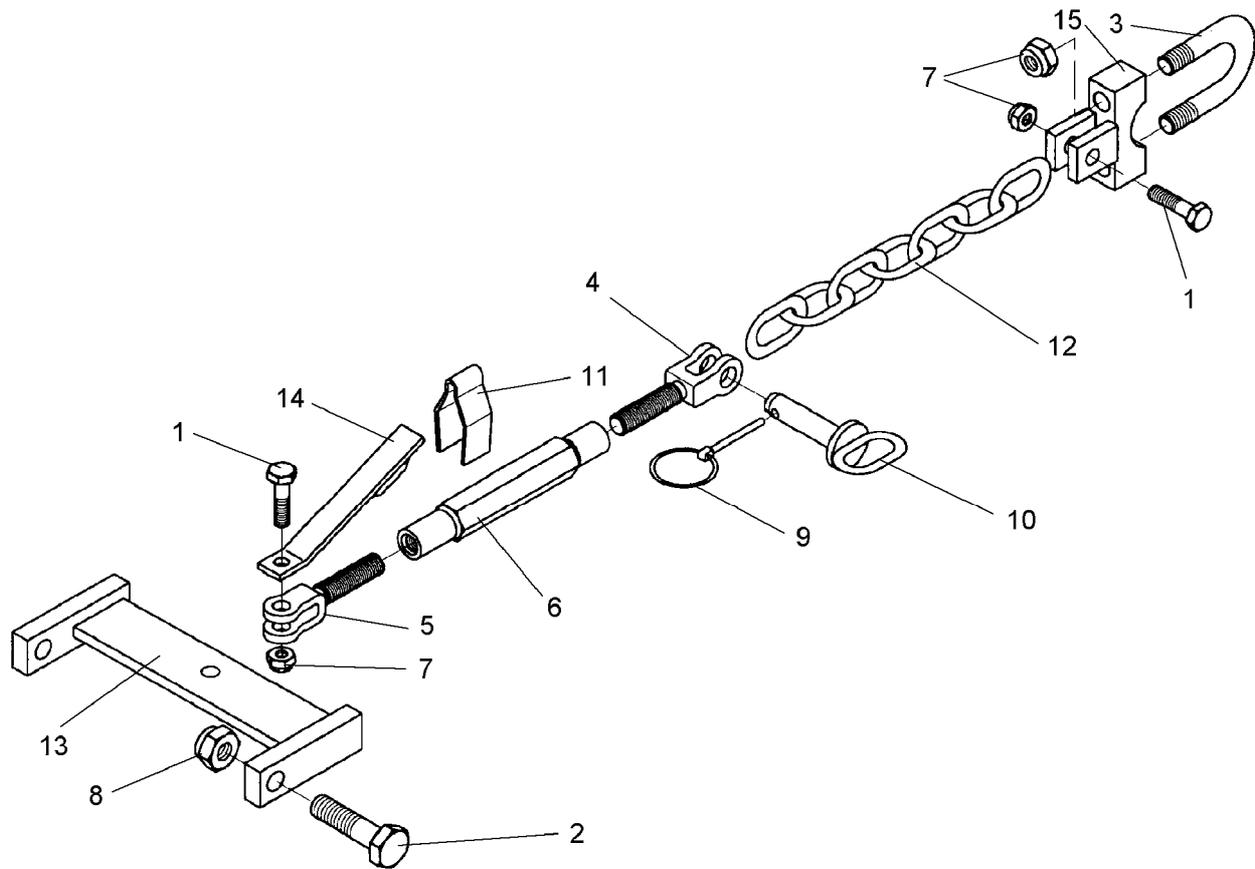

11.04

Pos.	Art.-Nr.	Stk.	Artikeltext / Description		Abmessung
1	301 4602	2	Sechskantschraube spz.	Bolt	M20x75-8.8
2	301 4661	2	Sechskantschraube DIN931-A	Bolt	M24x100ls70xb25-10.9
3	301 7825	1	Bügelsschraube	U-bolt	M20-D69x90 (320)
4	302 8980	1	Gabelstück	Forkpiece	TR24x3
5	302 8981	1	Gabelstück	Forkpiece	TR24x3LH
6	302 8892	1	Spannschloßmutter	Threaded sleeve	TR24x3x250
7	303 0936	4	Sicherungsmutter	Selflocking nut	DIN985-NM20-8 Zn
8	303 0937	2	Sicherungsmutter	Selflocking nut	DIN985-NM24-8 Zn
9	311 9565	1	Klappstift	Securing pin	4,5mm
10	313 8147	1	Bolzen mit Griff	Pin with grip	GB D20x68/78
11	329 1792	1	Flachformfeder	U-spring	40x4x230 SW46
12	331 6584	1	Kette DIN762	Chain	13x65 7GL ST35.2H Zn
13	461 6172	1	Zugschiene	Drawbar	350x165 2xD25 D20,25
14	461 6173	1	Halter	Holder	35x8x250 D21
15	461 6174	1	Klemmbügel	Clamp strap	40x140x50 3xD20,25

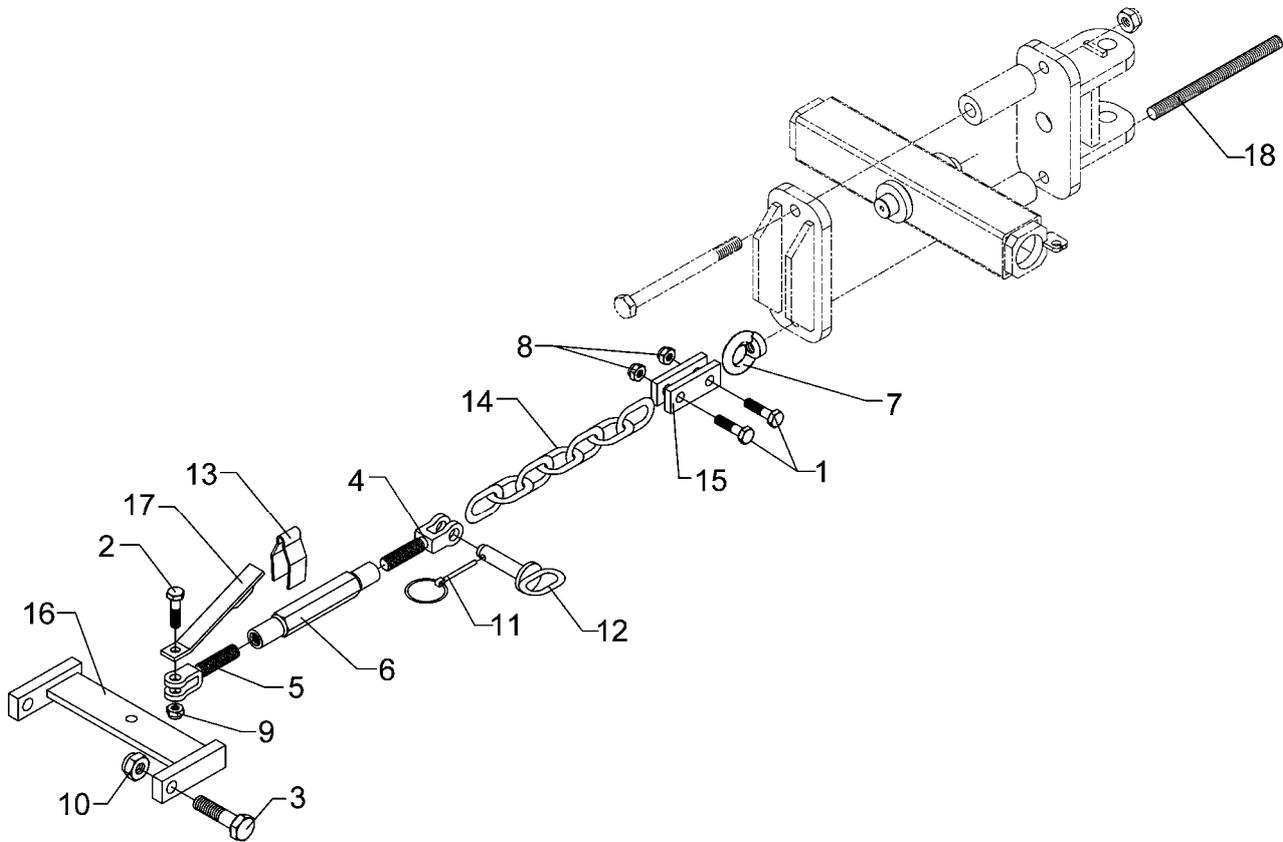

11.04

Pos.	Art.-Nr.	Stk.	Artikeltext / Description		Abmessung
1	301 3838	2	Sechskantschraube DIN931-A	Bolt	M16x60-8.8
2	301 4602	1	Sechskantschraube spz.	Bolt	M20x75-8.8
3	301 4661	2	Sechskantschraube DIN931-A	Bolt	M24x100ls70xb25-10.9
4	302 8980	1	Gabelstück	Forkpiece	TR24x3
5	302 8981	1	Gabelstück	Forkpiece	TR24x3LH
6	302 8892	1	Spannschloßmutter	Threaded sleeve	TR24x3x250
7	303 0331	1	Ringmutter	Eye nut	M30 DIN582
8	303 0935	2	Sicherungsmutter	Selflocking nut	DIN985-NM16-8 Zn
9	303 0936	1	Sicherungsmutter	Selflocking nut	DIN985-NM20-8 Zn
10	303 0937	2	Sicherungsmutter	Selflocking nut	DIN985-NM24-8 Zn
11	311 9565	1	Klappstift	Securing pin	4,5mm
12	313 8147	1	Bolzen mit Griff	Pin with grip	GB D20x68/78
13	329 1792	1	Flachformfeder	U-spring	40x4x230 SW46
14	331 6584	1	Kette DIN762	Chain	13x65 7GL ST35.2H Zn
15	459 1001	2	Brücke	Clamp plate	40x10x100 1x70-D16,5
16	461 6172	1	Zugschiene	Drawbar	350x165 2xD25 D20,25
17	461 6173	1	Halter	Holder	35x8x250 D21
18	302 0123	1	Gewindestange	Threaded rod	M30x270 Zn

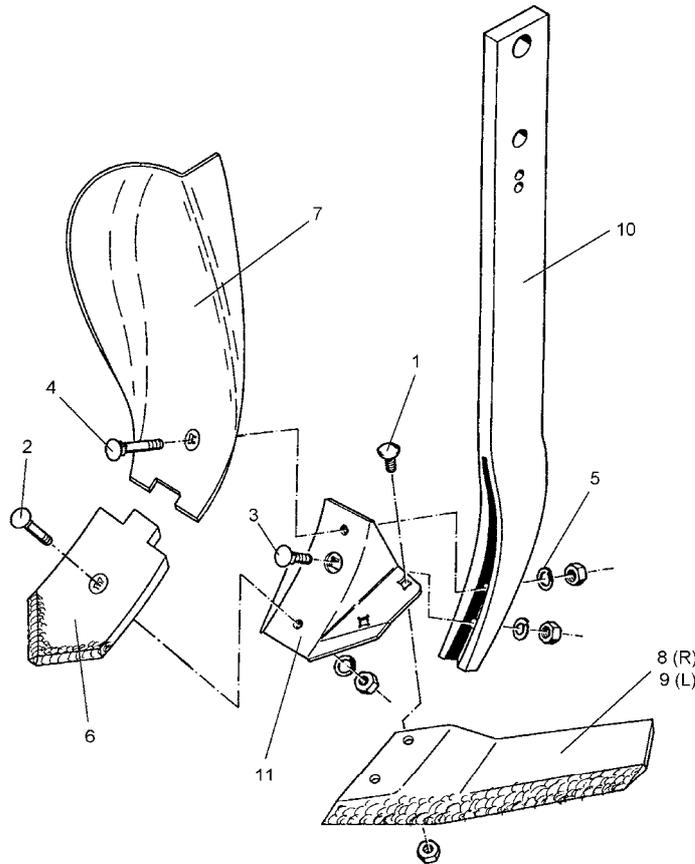

11.04

Pos.	Art.-Nr.	Stk.	Artikeltext / Description	Abmessung	
1	301 1805	4	Flachrundschaube mit Mutter	Bolt, cup square head	M12x30-10.9 MU
2	301 5789	1	Senkschraube	Countersunk bolt	M12x36-12.9-MU-10
3	301 5786	1	Senkschraube	Countersunk bolt	M12x55x20-12.9-MU
4	301 5787	1	Senkschraube	Countersunk bolt	M12x65x20-12.9-MU
5	305 9885	3	Federring	Spring ring	12 DIN127
6	337 4392	1	Scharfspitze aufgepanzert	Point	S12P 120x12x230
7	337 4398	1	Randleitblech	Guideboard, outer	LBR2 RE
8	337 4424	1	Flügelschar	Flügelschar	FL37P GEK RE 11x130x381
9	337 4425	1	Flügelschar	Flügelschar	FL37P GEK LI 11x130x381
11	467 9105	1	Scharfuß	Foot	8-S/FL

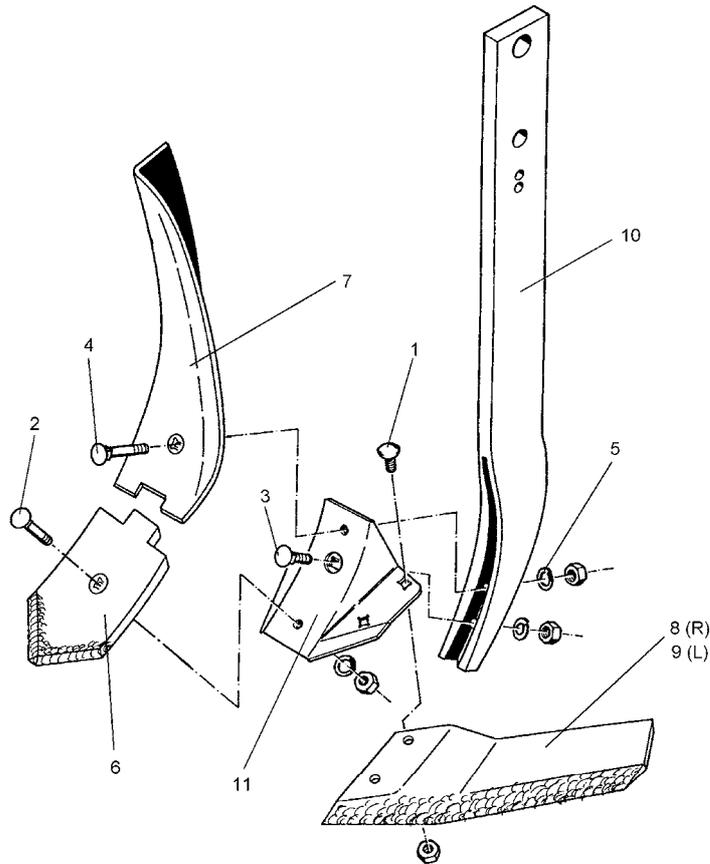

11.04

Pos.	Art.-Nr.	Stk.	Artikeltext / Description	Abmessung	
1	301 1805	4	Flachrundschaube mit Mutter	Bolt, cup square head	M12x30-10.9 MU
2	301 5785	1	Senkschraube	Countersunk bolt	M12x33-12.9-MU-10
3	301 5786	1	Senkschraube	Countersunk bolt	M12x55x20-12.9-MU
4	301 5787	1	Senkschraube	Countersunk bolt	M12x65x20-12.9-MU
5	305 9885	3	Federring	Spring ring	12 DIN127
6	337 4392	1	Scharspitze aufgepanzert	Point	S12P 120x12x230
7	337 4399	1	Randleitblech	Guideboard, outer	LBR2 LI
8	337 4424	1	Flügelschar	Flügelschar	FL37P GEK RE 11x130x381
9	337 4425	1	Flügelschar	Flügelschar	FL37P GEK LI 11x130x381
10	465 3680	1	Halm	Stalk	70x22x875
11	467 9105	1	Scharfuß	Foot	8-S/FL

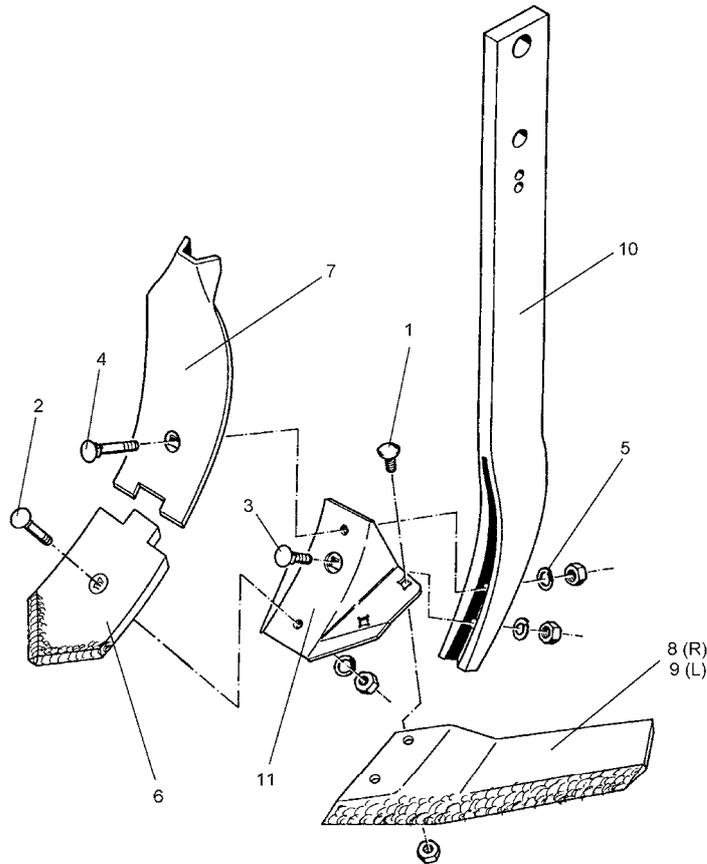

11.04

Pos.	Art.-Nr.	Stk.	Artikeltext / Description	Abmessung	
1	301 1805	4	Flachrundschaube mit Mutter	Bolt, cup square head	M12x30-10.9 MU
2	301 5785	1	Senkschraube	Countersunk bolt	M12x33-12.9-MU-10
3	301 5786	1	Senkschraube	Countersunk bolt	M12x55x20-12.9-MU
4	301 5787	1	Senkschraube	Countersunk bolt	M12x65x20-12.9-MU
5	305 9885	3	Federring	Spring ring	12 DIN127
6	337 4392	1	Scharspitze aufgepanzert	Point	S12P 120x12x230
7	337 4395	1	Leitblech	Guideboard	LB1 100x8x305
8	337 4424	1	Flügelschar	Flügelschar	FL37P GEK RE 11x130x381
9	337 4425	1	Flügelschar	Flügelschar	FL37P GEK LI 11x130x381
10	465 3680	1	Halm	Stalk	70x22x875
11	467 9105	1	Scharfuß	Foot	8-S/FL

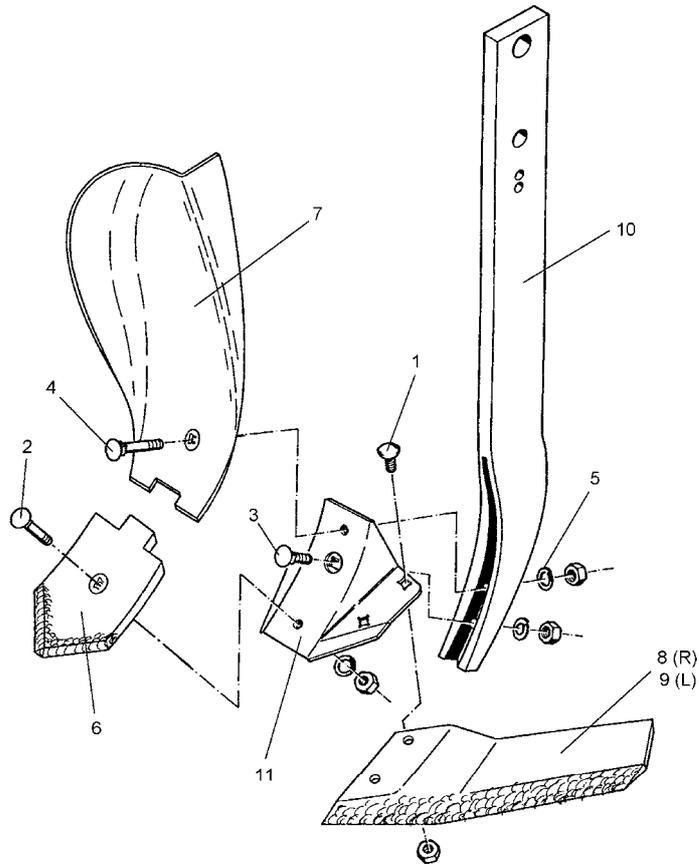

11.04

Pos.	Art.-Nr.	Stk.	Artikeltext / Description	Abmessung	
1	301 1805	4	Flachrundschaube mit Mutter	Bolt, cup square head	M12x30-10.9 MU
2	301 5789	1	Senkschraube	Countersunk bolt	M12x36-12.9-MU-10
3	301 5786	1	Senkschraube	Countersunk bolt	M12x55x20-12.9-MU
4	301 5787	1	Senkschraube	Countersunk bolt	M12x65x20-12.9-MU
5	305 9885	3	Federring	Spring ring	12 DIN127
6	337 4391	1	Scharspitze zum Smaragd	Point	S12PK 120x12x200
7	337 4398	1	Randleitblech	Guideboard, outer	LBR2 RE
8	337 4424	1	Flügelschar	Flügelschar	FL37P GEK RE 11x130x381
9	337 4425	1	Flügelschar	Flügelschar	FL37P GEK LI 11x130x381
10	465 3680	1	Halm	Stalk	70x22x875
11	467 9105	1	Scharfuß	Foot	8-S/FL

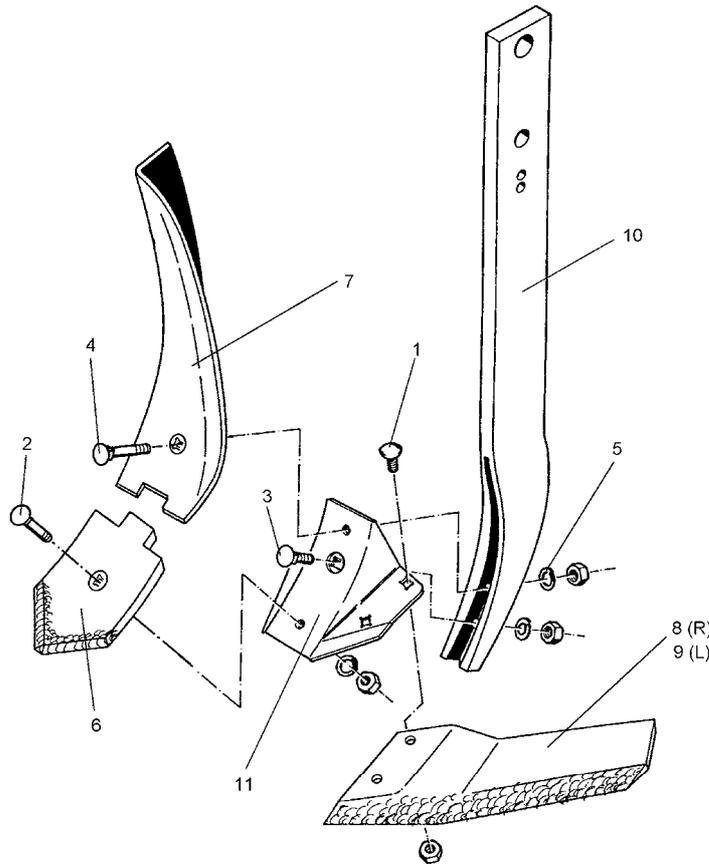

11.04

Pos.	Art.-Nr.	Stk.	Artikeltext / Description	Abmessung	
1	301 1805	4	Flachrundschaube mit Mutter	Bolt, cup square head	M12x30-10.9 MU
2	301 5789	1	Senkschraube	Countersunk bolt	M12x36-12.9-MU-10
3	301 5786	1	Senkschraube	Countersunk bolt	M12x55x20-12.9-MU
4	301 5787	1	Senkschraube	Countersunk bolt	M12x65x20-12.9-MU
5	305 9885	3	Federring	Spring ring	12 DIN127
6	337 4391	1	Scharspitze zum Smaragd	Point	S12PK 120x12x200
7	337 4399	1	Randleitblech	Guideboard, outer	LBR2 LI
8	337 4424	1	Flügelschar	Flügelschar	FL37P GEK RE 11x130x381
9	337 4425	1	Flügelschar	Flügelschar	FL37P GEK LI 11x130x381
10	465 3680	1	Halm	Stalk	70x22x875
11	467 9105	1	Scharfuß	Foot	8-S/FL

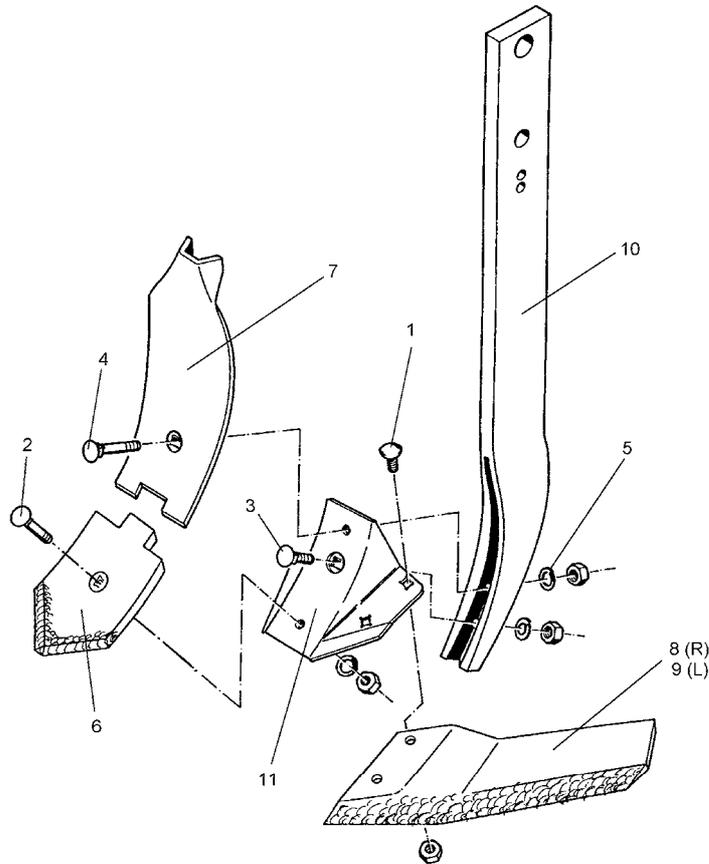

11.04

Pos.	Art.-Nr.	Stk.	Artikeltext / Description	Abmessung	
1	301 1805	4	Flachrundschaube mit Mutter	Bolt, cup square head	M12x30-10.9 MU
2	301 5789	1	Senkschraube	Countersunk bolt	M12x36-12.9-MU-10
3	301 5786	1	Senkschraube	Countersunk bolt	M12x55x20-12.9-MU
4	301 5787	1	Senkschraube	Countersunk bolt	M12x65x20-12.9-MU
5	305 9885	3	Federring	Spring ring	12 DIN127
6	337 4391	1	Scharspitze zum Smaragd	Point	S12PK 120x12x200
7	337 4395	1	Leitblech	Guideboard	LB1 100x8x305
8	337 4424	1	Flügelschar	Flügelschar	FL37P GEK RE 11x130x381
9	337 4425	1	Flügelschar	Flügelschar	FL37P GEK LI 11x130x381
10	465 3680	1	Halm	Stalk	70x22x875
11	467 9105	1	Scharfuß	Foot	8-S/FL

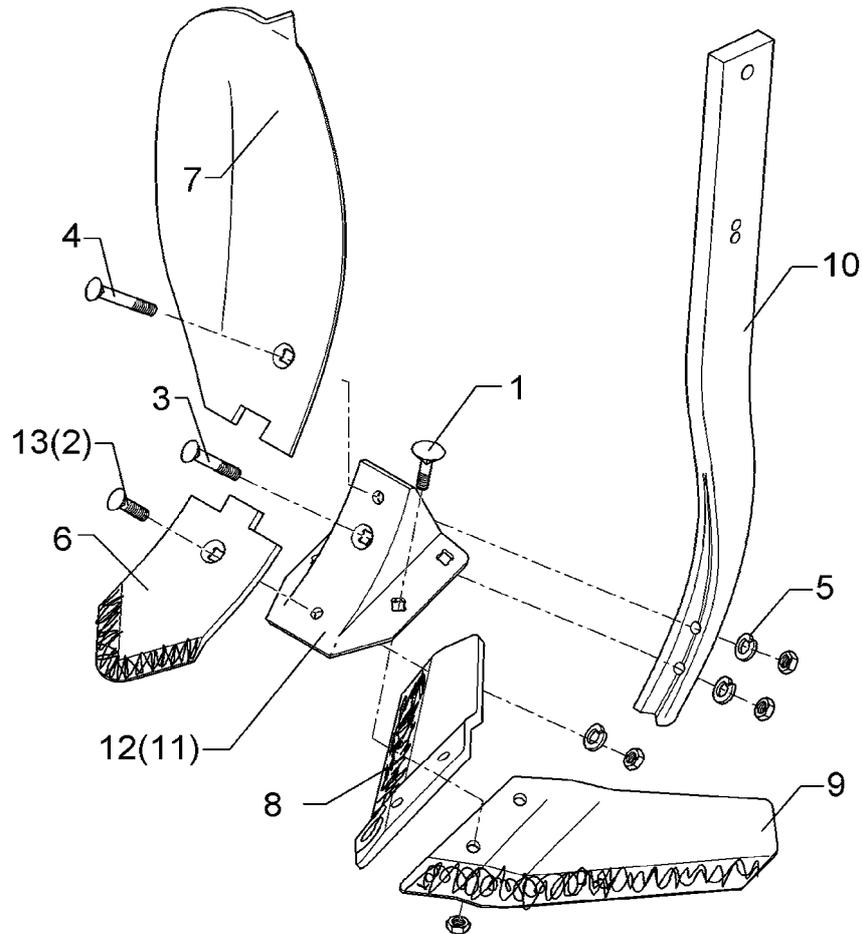

11.04

Pos.	Art.-Nr.	Stk.	Artikeltext / Description	Abmessung	
1	301 1805	4	Flachrundschaube mit Mutter	Bolt, cup square head	M12x30-10.9 MU
2	301 5785	1	Senkschraube	Countersunk bolt	M12x33-12.9-MU-10
3	301 5786	1	Senkschraube	Countersunk bolt	M12x55x20-12.9-MU
4	301 5787	1	Senkschraube	Countersunk bolt	M12x65x20-12.9-MU
5	305 9885	3	Federring	Spring ring	12 DIN127
6	337 4392	1	Scharspitze aufgepanzert	Point	S12P 120x12x230
7	337 4398	1	Randleitblech	Guideboard, outer	LBR2 RE
8	337 4424	1	Flügelschar	Flügelschar	FL37P GEK RE 11x130x381
9	337 4425	1	Flügelschar	Flügelschar	FL37P GEK LI 11x130x381
10	465 3681	1	Halm	Stalk	70x22x795-D16 (Ü)
11	467 9105	1	Scharfuß	Foot	8-S/FL
12	467 9106	1	Scharfuß	Foot	10-S/FL
13	301 5789	1	Senkschraube	Countersunk bolt	M12x36-12.9-MU-10

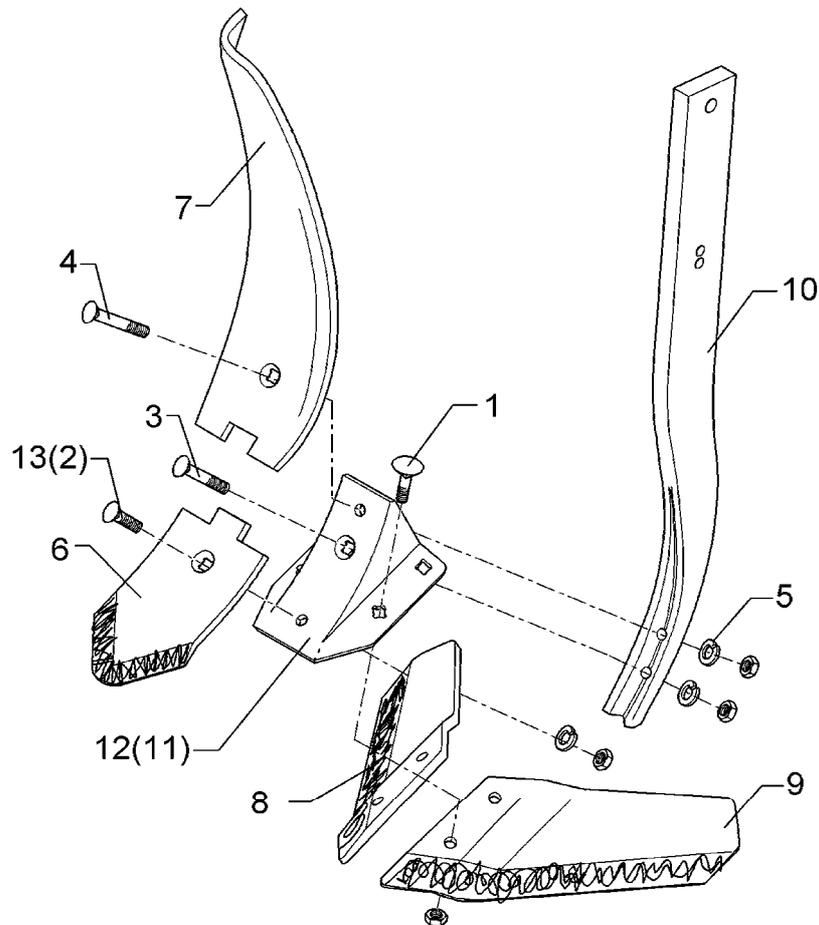

11.04

Pos.	Art.-Nr.	Stk.	Artikeltext / Description	Abmessung	
1	301 1805	4	Flachrundschaube mit Mutter	Bolt, cup square head	M12x30-10.9 MU
2	301 5785	1	Senkschraube	Countersunk bolt	M12x33-12.9-MU-10
3	301 5786	1	Senkschraube	Countersunk bolt	M12x55x20-12.9-MU
4	301 5787	1	Senkschraube	Countersunk bolt	M12x65x20-12.9-MU
5	305 9885	3	Federring	Spring ring	12 DIN127
6	337 4392	1	Scharspitze aufgepanzert	Point	S12P 120x12x230
7	337 4399	1	Randleitblech	Guideboard, outer	LBR2 LI
8	337 4424	1	Flügelschar	Flügelschar	FL37P GEK RE 11x130x381
9	337 4425	1	Flügelschar	Flügelschar	FL37P GEK LI 11x130x381
10	465 3681	1	Halm	Stalk	70x22x795-D16 (Ü)
11	467 9105	1	Scharfuß	Foot	8-S/FL
12	467 9106	1	Scharfuß	Foot	10-S/FL
13	301 5789	1	Senkschraube	Countersunk bolt	M12x36-12.9-MU-10

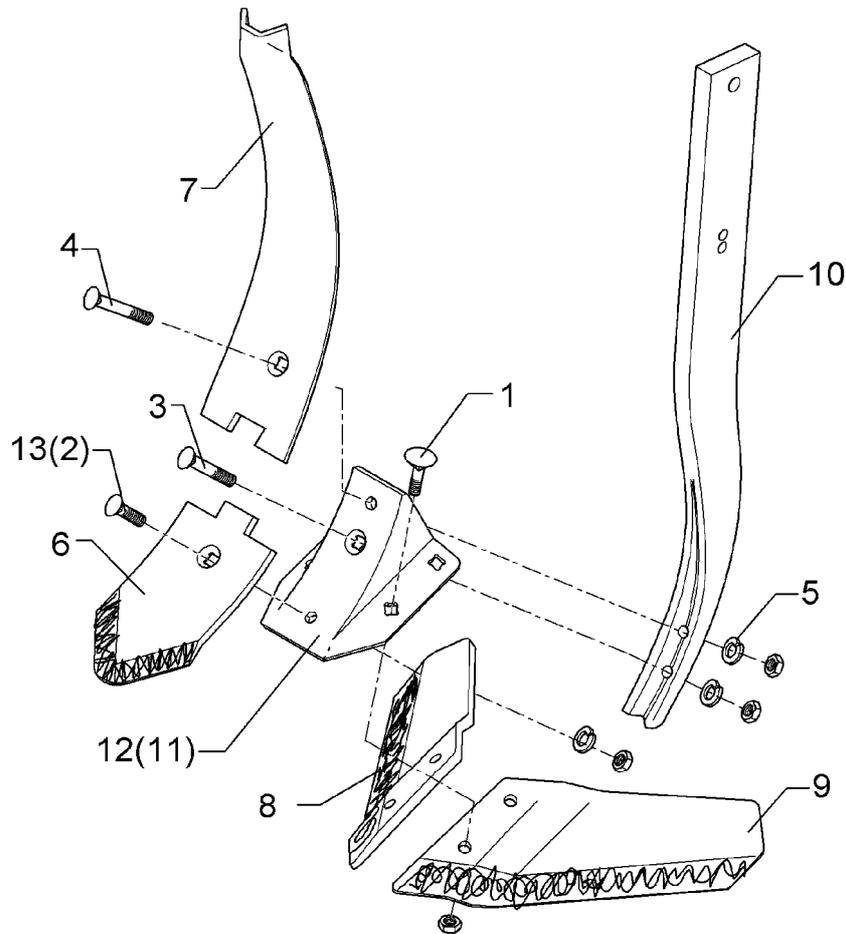

11.04

Pos.	Art.-Nr.	Stk.	Artikeltext / Description	Abmessung	
1	301 1805	4	Flachrundschaube mit Mutter	Bolt, cup square head	M12x30-10.9 MU
2	301 5785	1	Senkschraube	Countersunk bolt	M12x33-12.9-MU-10
3	301 5786	1	Senkschraube	Countersunk bolt	M12x55x20-12.9-MU
4	301 5787	1	Senkschraube	Countersunk bolt	M12x65x20-12.9-MU
5	305 9885	3	Federring	Spring ring	12 DIN127
6	337 4392	1	Scharspitze aufgepanzert	Point	S12P 120x12x230
7	337 4395	1	Leitblech	Guideboard	LB1 100x8x305
8	337 4424	1	Flügelschar	Flügelschar	FL37P GEK RE 11x130x381
9	337 4425	1	Flügelschar	Flügelschar	FL37P GEK LI 11x130x381
10	465 3681	1	Halm	Stalk	70x22x795-D16 (Ü)
11	467 9105	1	Scharfuß	Foot	8-S/FL
12	467 9106	1	Scharfuß	Foot	10-S/FL
13	301 5789	1	Senkschraube	Countersunk bolt	M12x36-12.9-MU-10

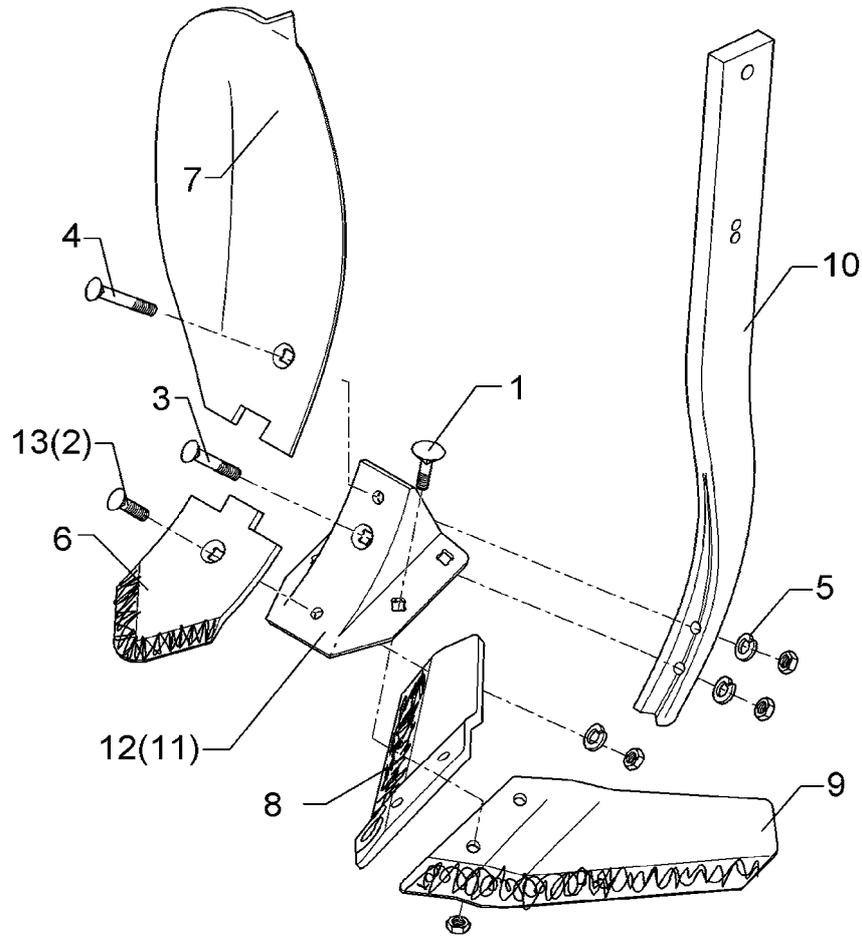

11.04

Pos.	Art.-Nr.	Stk.	Artikeltext / Description	Abmessung	
1	301 1805	4	Flachrundschaube mit Mutter	Bolt, cup square head	M12x30-10.9 MU
2	301 5785	1	Senkschraube	Countersunk bolt	M12x33-12.9-MU-10
3	301 5786	1	Senkschraube	Countersunk bolt	M12x55x20-12.9-MU
4	301 5787	1	Senkschraube	Countersunk bolt	M12x65x20-12.9-MU
5	305 9885	3	Federring	Spring ring	12 DIN127
6	337 4391	1	Scharspitze zum Smaragd	Point	S12PK 120x12x200
7	337 4398	1	Randleitblech	Guideboard, outer	LBR2 RE
8	337 4424	1	Flügelschar	Flügelschar	FL37P GEK RE 11x130x381
9	337 4425	1	Flügelschar	Flügelschar	FL37P GEK LI 11x130x381
10	465 3681	1	Halm	Stalk	70x22x795-D16 (Ü)
11	467 9105	1	Scharfuß	Foot	8-S/FL
12	467 9106	1	Scharfuß	Foot	10-S/FL
13	301 5789	1	Senkschraube	Countersunk bolt	M12x36-12.9-MU-10

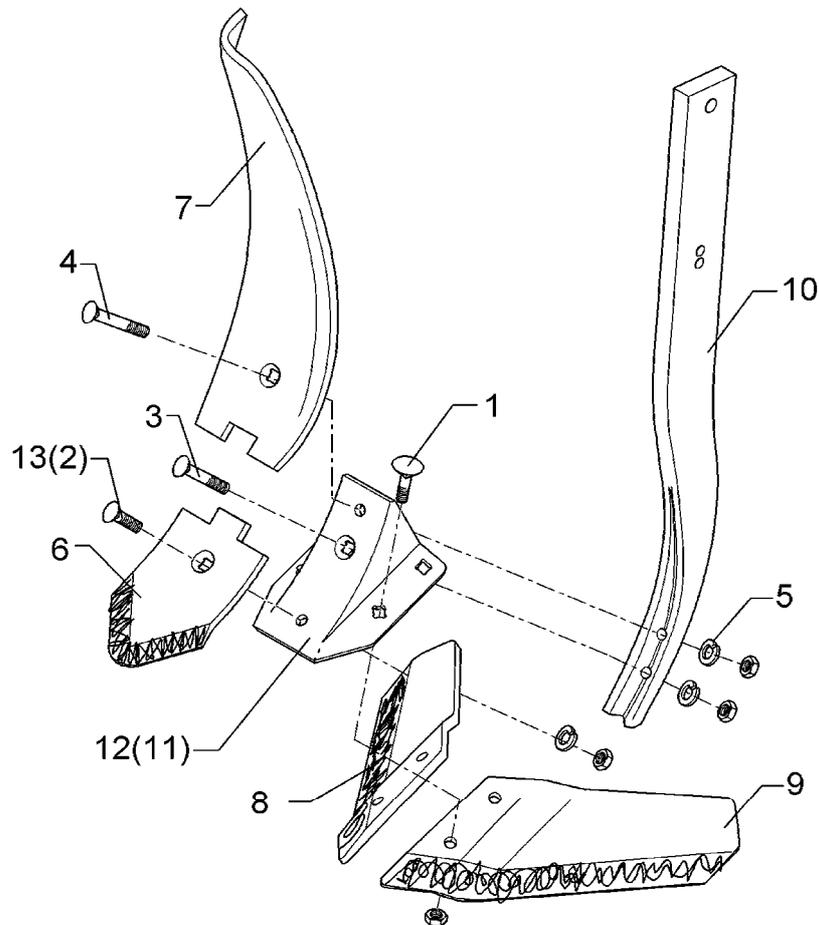

11.04

Pos.	Art.-Nr.	Stk.	Artikeltext / Description	Abmessung	
1	301 1805	4	Flachrundschaube mit Mutter	Bolt, cup square head	M12x30-10.9 MU
2	301 5785	1	Senkschraube	Countersunk bolt	M12x33-12.9-MU-10
3	301 5786	1	Senkschraube	Countersunk bolt	M12x55x20-12.9-MU
4	301 5787	1	Senkschraube	Countersunk bolt	M12x65x20-12.9-MU
5	305 9885	3	Federring	Spring ring	12 DIN127
6	337 4391	1	Scharspitze zum Smaragd	Point	S12PK 120x12x200
7	337 4399	1	Randleitblech	Guideboard, outer	LBR2 LI
8	337 4424	1	Flügelschar	Flügelschar	FL37P GEK RE 11x130x381
9	337 4425	1	Flügelschar	Flügelschar	FL37P GEK LI 11x130x381
10	465 3681	1	Halm	Stalk	70x22x795-D16 (Ü)
11	467 9105	1	Scharfuß	Foot	8-S/FL
12	467 9106	1	Scharfuß	Foot	10-S/FL
13	301 5789	1	Senkschraube	Countersunk bolt	M12x36-12.9-MU-10

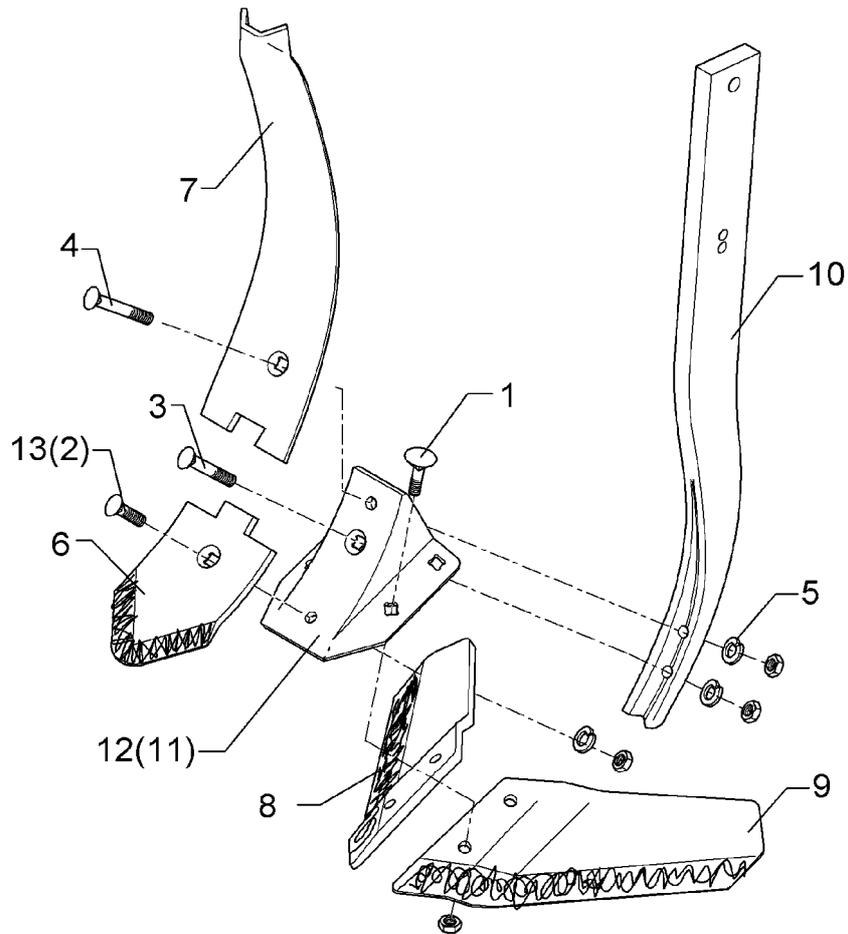

11.04

Pos.	Art.-Nr.	Stk.	Artikeltext / Description	Abmessung	
1	301 1805	4	Flachrundschaube mit Mutter	Bolt, cup square head	M12x30-10.9 MU
2	301 5785	1	Senkschraube	Countersunk bolt	M12x33-12.9-MU-10
3	301 5786	1	Senkschraube	Countersunk bolt	M12x55x20-12.9-MU
4	301 5787	1	Senkschraube	Countersunk bolt	M12x65x20-12.9-MU
5	305 9885	3	Federring	Spring ring	12 DIN127
6	337 4391	1	Scharspitze zum Smaragd	Point	S12PK 120x12x200
7	337 4395	1	Leitblech	Guideboard	LB1 100x8x305
8	337 4424	1	Flügelschar	Flügelschar	FL37P GEK RE 11x130x381
9	337 4425	1	Flügelschar	Flügelschar	FL37P GEK LI 11x130x381
10	465 3681	1	Halm	Stalk	70x22x795-D16 (Ü)
11	467 9105	1	Scharfuß	Foot	8-S/FL
12	467 9106	1	Scharfuß	Foot	10-S/FL
13	301 5789	1	Senkschraube	Countersunk bolt	M12x36-12.9-MU-10

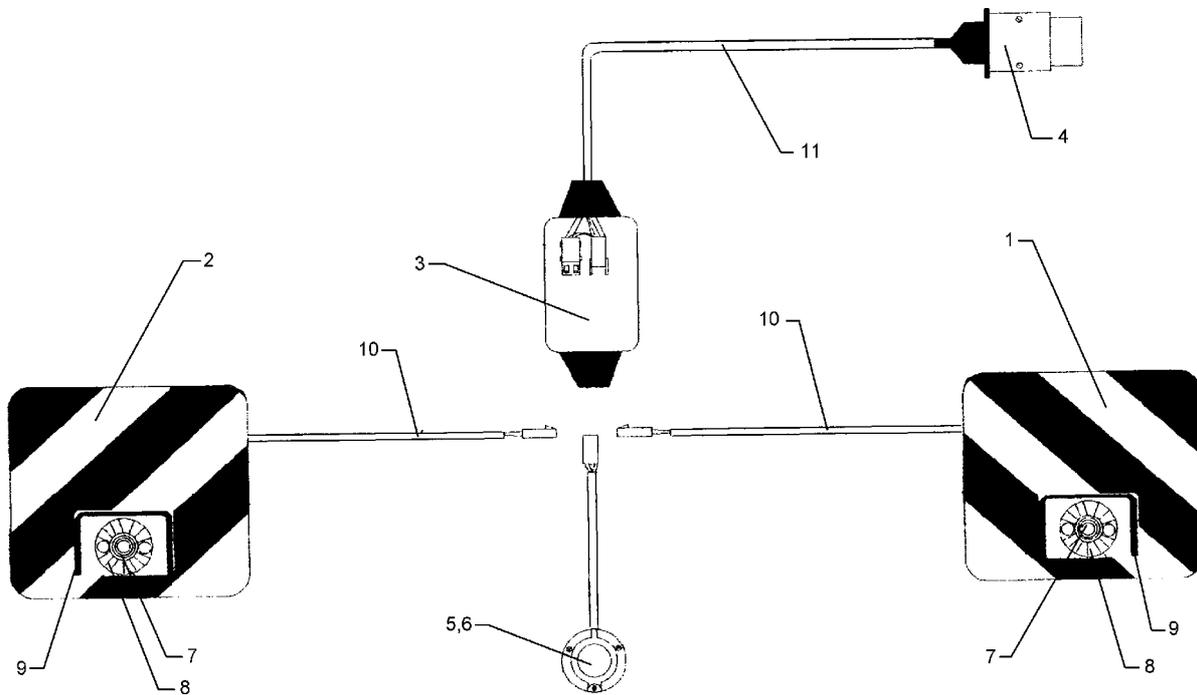

11.04

Pos.	Art.-Nr.	Stk.	Artikeltext / Description		Abmessung
1	321 9934	1	Warntafel	Warning board	RE 423x423 DIN11030
2	321 9935	1	Warntafel	Warning board	LI 423x423 DIN11030
3	373 2017	1	Verteilerdose	Junction box	1216.
4	373 2124	1	Stecker Alu	Plug	7-polig
5	373 2126	1	Steckdose	Plug box	7-polig 71/7F
6	373 2131	1	Steckdosenunterlage	Base of plug box	709
7	373 3431	2	Positionsleuchte	Position light	PL86
8	373 3529	2	Lichtscheibe	Light glas	E86
9	373 3802	2	Schutzhaube vorne	Front cover	SH86
10	373 4134	1	Kabel	Cable	2x0,75 S/W
11	373 4140	5	Kabel	Cable	6x0,75 S/W

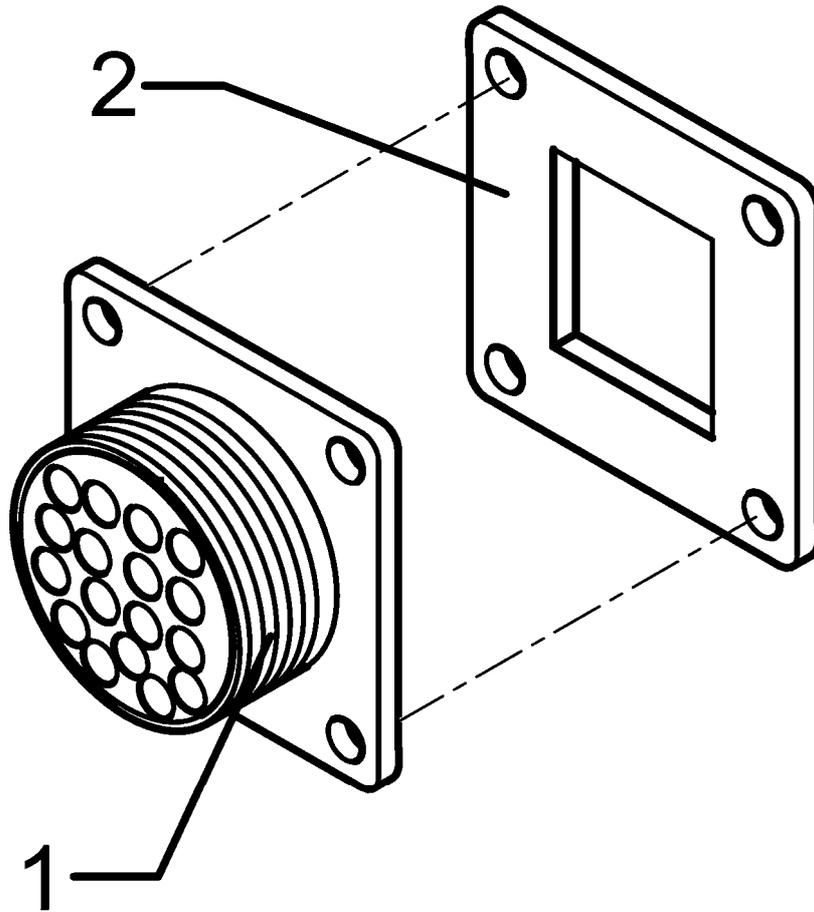

11.04

Pos.	Art.-Nr.	Stk.	Artikeltext / Description	Abmessung
1	573 5084	1	Flanschstecker	Flanged plug
2	573 5085	1	Dichtung f.Flanschstecker	Seal
				CME 20-29P 17 Pins
				CM 02D 20 ZU

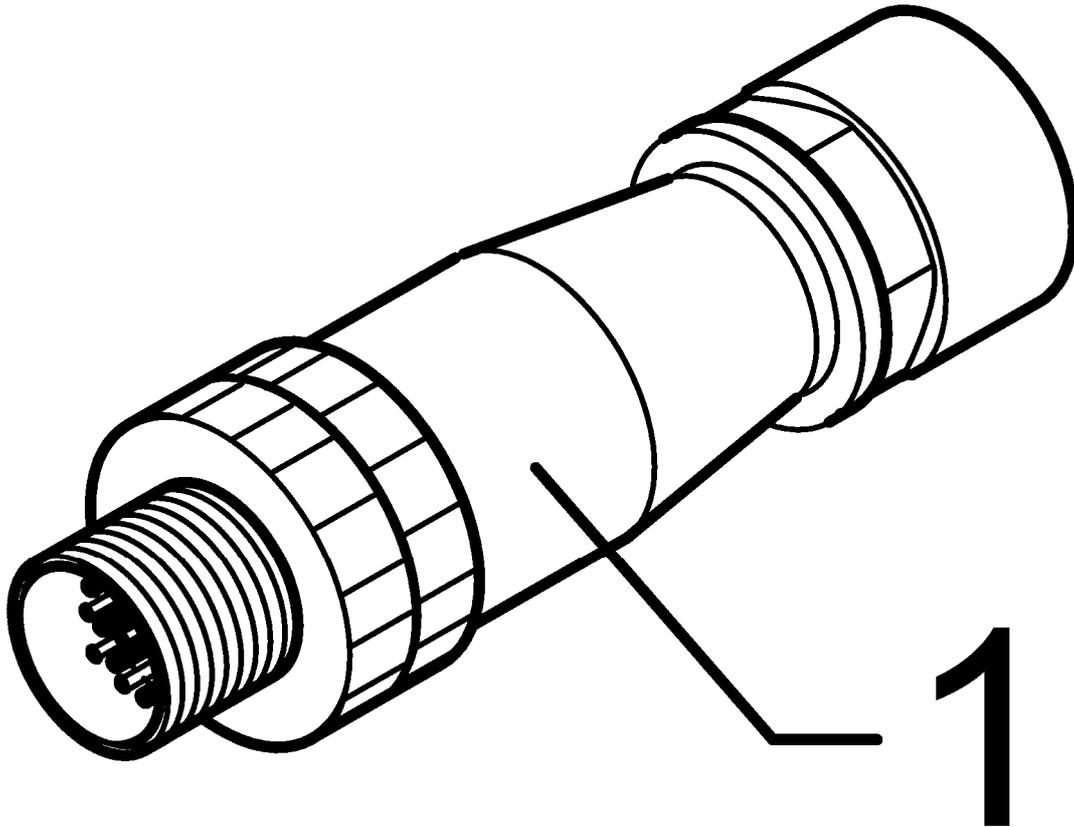

11.04

Pos.	Art.-Nr.	Stk.	Artikeltext / Description	Abmessung	
1	573 5086	1	Buchse 17-polig	Bush 17-poles	CM 06 EA 20-29S

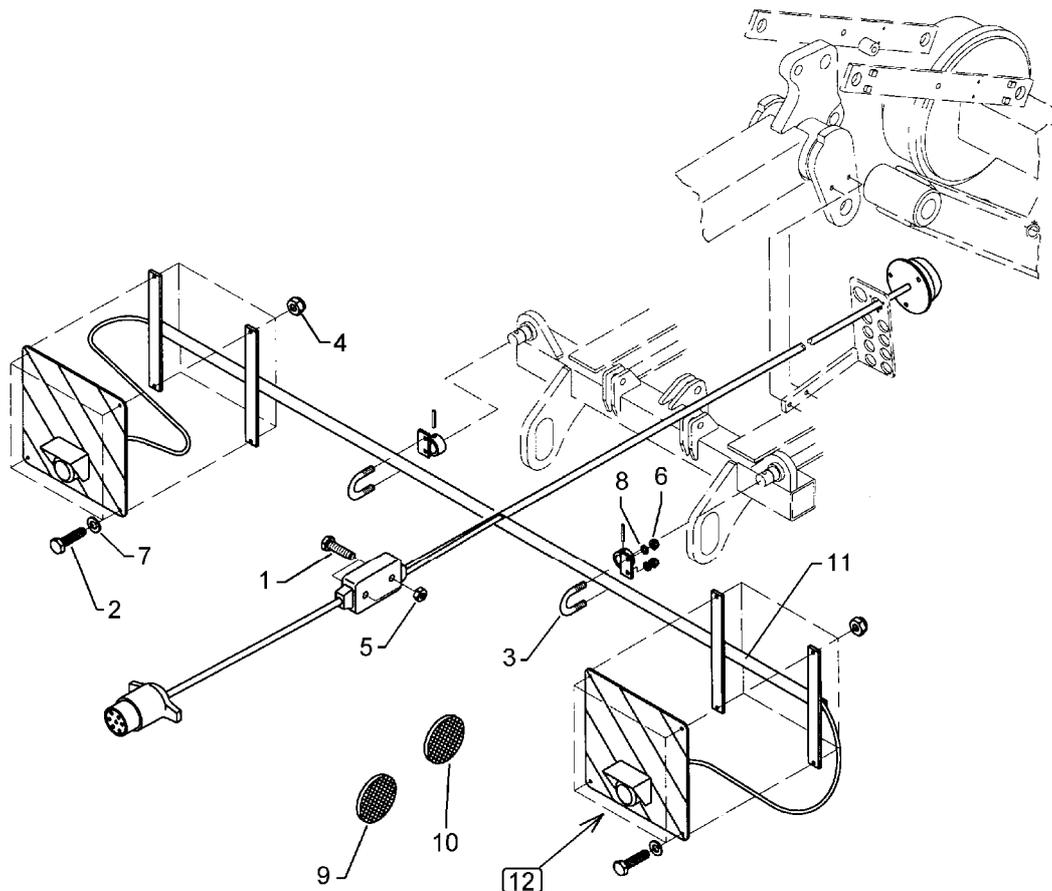

11.04

Pos.	Art.-Nr.	Stk.	Artikeltext / Description	Abmessung	
1	301 2996	2	Sechskantschraube DIN933	Screw	M5x30-8.8
2	301 7280	8	Sechskantschraube DIN933	Screw	M8x25-8.8 Zn
3	301 7781	2	Bügelsschraube	U-bolt	M10x38x76 DIN3570A Zn
4	303 0932	8	Sicherungsmutter	Selflocking nut	DIN985-NM8-8 Zn
5	303 0967	2	Sechskantmutter	Nut	M5 DIN934-8 Zn
6	303 0970	4	Sechskantmutter	Nut	M10 DIN934-8
7	305 8694	8	Scheibe	Washer	A8,4 DIN125-St Zn
8	305 9900	4	Federring	Spring ring	10 DIN127 Zn
9	321 9918	2	Rückstrahler rot selbstkl.	Self-adh. reflector, red	8200K
10	321 9919	6	Rückstrahler gelb selbstkl.	Self-adh. reflector, yellow	6200GK
11	470 1649	1	Leuchtenhalter	Carrier for light	D33,7x4,5x2900
12	570 1902	1	Beleuchtungsanlage vorne	Lighting equipment, front	Smaragd 9 KA B

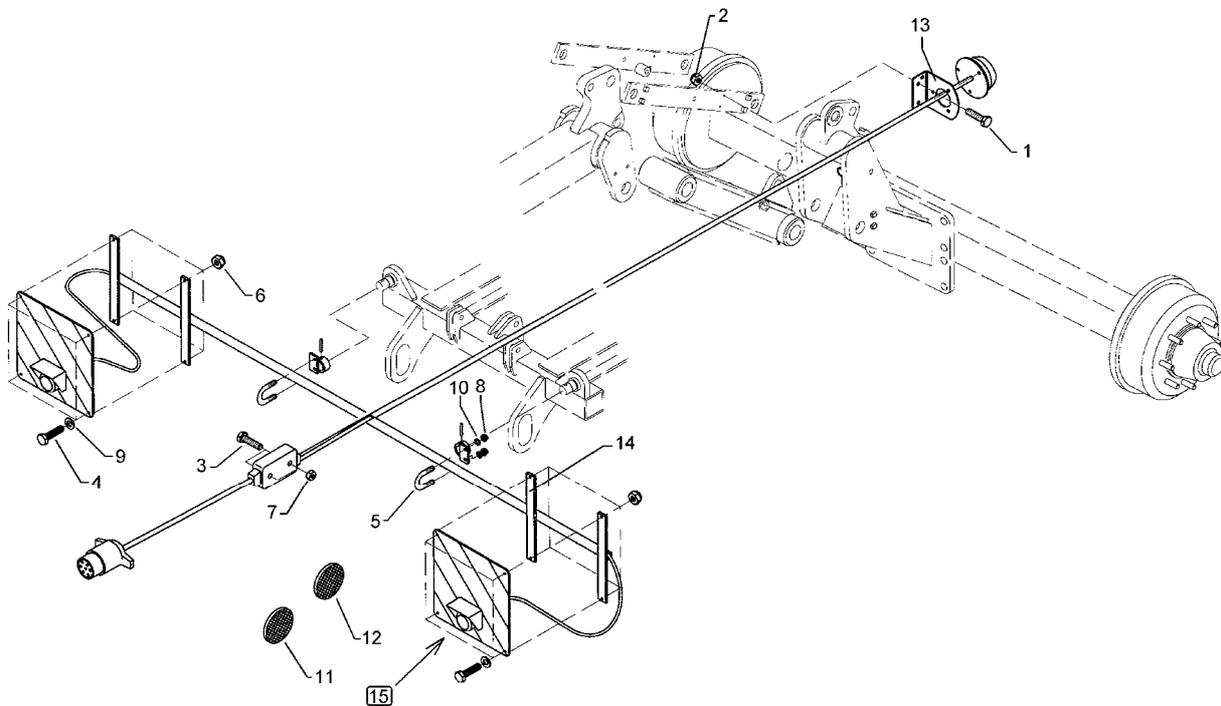

11.04

Pos.	Art.-Nr.	Stk.	Artikeltext / Description		Abmessung
1	301 0302	2	Flachkopfschraube DIN85	Flatheaded bolt	M6x25-4,6 Zn
2	303 0931	2	Sicherungsmutter	Selflocking nut	DIN985-NM6-8 Zn
3	301 2996	2	Sechskantschraube DIN933	Screw	M5x30-8.8
4	301 7280	8	Sechskantschraube DIN933	Screw	M8x25-8.8 Zn
5	301 7781	2	Bügelsschraube	U-bolt	M10x38x76 DIN3570A Zn
6	303 0932	8	Sicherungsmutter	Selflocking nut	DIN985-NM8-8 Zn
7	303 0967	2	Sechskantmutter	Nut	M5 DIN934-8 Zn
8	303 0970	4	Sechskantmutter	Nut	M10 DIN934-8
9	305 8694	8	Scheibe	Washer	A8,4 DIN125-St Zn
10	305 9900	4	Federring	Spring ring	10 DIN127 Zn
11	321 9918	2	Rückstrahler rot selbstkl.	Self-adh. reflector, red	8200K
12	321 9919	6	Rückstrahler gelb selbstkl.	Self-adh. reflector, yellow	6200GK
13	373 2130	1	Steckdosenhalter	Holder for plug socket	H 71
14	470 1649	1	Leuchtenhalter	Carrier for light	D33,7x4,5x2900
15	570 1902	1	Beleuchtungsanlage vorne	Lighting equipment, front	Smaragd 9 KA B

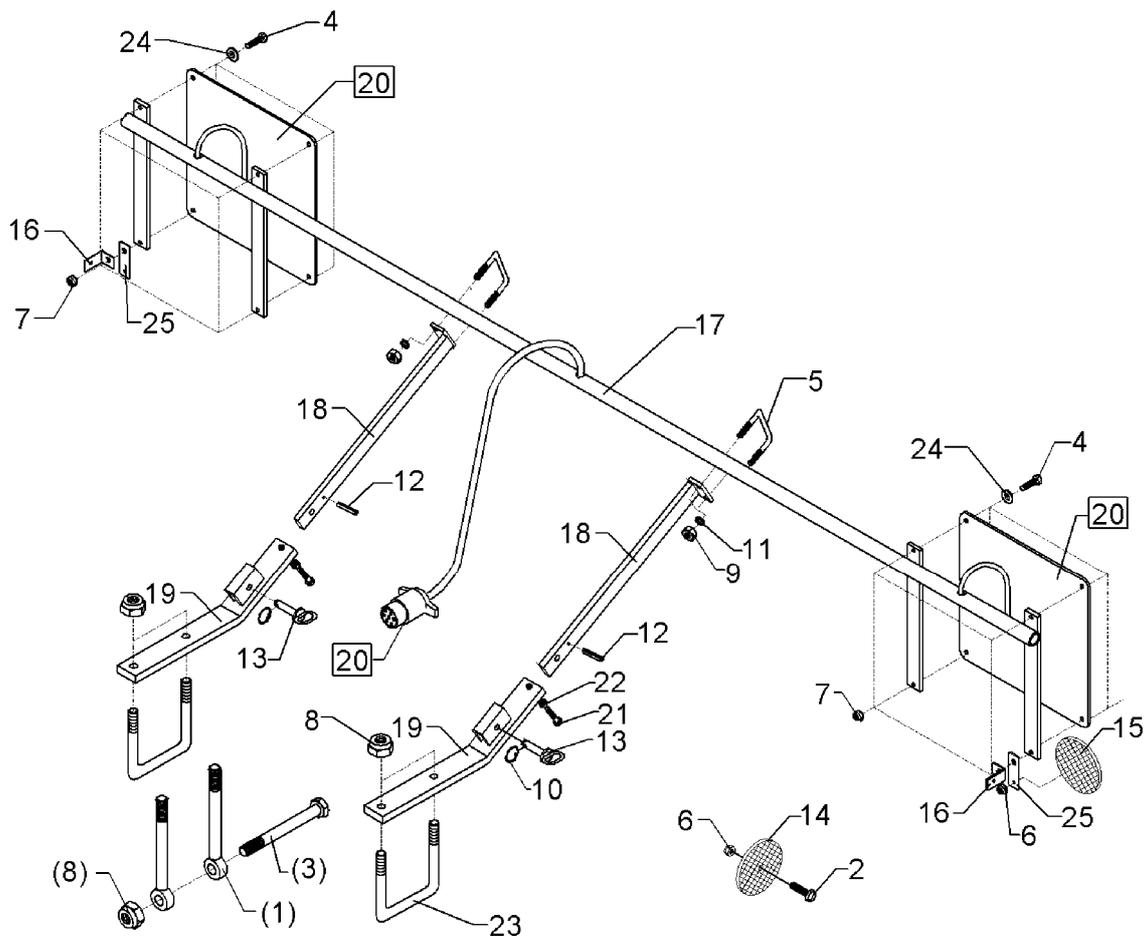

11.04

Pos.	Art.-Nr.	Stk.	Artikeltext / Description	Abmessung	
1	301 0864	4	Augenschraube DIN444	Eye bolt	BM16x200xb100-8.8 D2=16,1 Zn
2	301 0301	4	Flachkopfschraube DIN85	Flatheaded bolt	M6x20-4,6 Zn
3	301 4133	2	Sechskantschraube DIN931-A	Bolt	M16x200-8.8
4	301 7280	8	Sechskantschraube DIN933	Screw	M8x25-8.8 Zn
5	301 7781	2	Bügelschraube	U-bolt	M10x38x76 DIN3570A Zn
6	303 0931	4	Sicherungsmutter	Selflocking nut	DIN985-NM6-8 Zn
7	303 0932	8	Sicherungsmutter	Selflocking nut	DIN985-NM8-8 Zn
8	303 0935	4	Sicherungsmutter	Selflocking nut	DIN985-NM16-8 Zn
9	303 0970	4	Sechskantmutter	Nut	M10 DIN934-8
10	305 8551	2	Federsicherung	Securing clip	41x3
11	305 9900	4	Federring	Spring ring	10 DIN127 Zn
12	309 6054	2	Spannhülse	Expansion bush	6x40-DIN1481 Zn
13	313 7807	2	Bolzen mit Griff	Pin with grip	GB D12x57,5/71
14	321 9921	2	Rückstrahler gelb	Reflector, yellow	8 RA 002014-051
15	321 9922	2	Rückstrahler rot	Reflector, red	8 RA 002 016-111
16	470 1199	2	Halter gebogen	Holder	30x3x90
17	470 1649	1	Leuchtenhalter	Carrier for light	D33,7x4,5x2900
18	470 1664	2	Halter	Holder	40x15x550
19	470 1665	2	Halter	Holder	60x20x520 30GRD
20	570 2007	1	Beleuchtungsanlage hinten	Lighting equipment, rear	Aufsattelung
21	301 3350	2	Sechskantschraube DIN933	Screw	M12x50-8.8
22	303 1013	2	Sechskantmutter	Nut	M12 DIN934-8 Zn
23	301 7806	2	Bügelschraube	U-bolt	M16/150/195
24	305 8694	9	Scheibe	Washer	A8,4 DIN125-St Zn
25	459 0940	2	Halter	Holder	30x3x90 1x50-D10+7 Zn

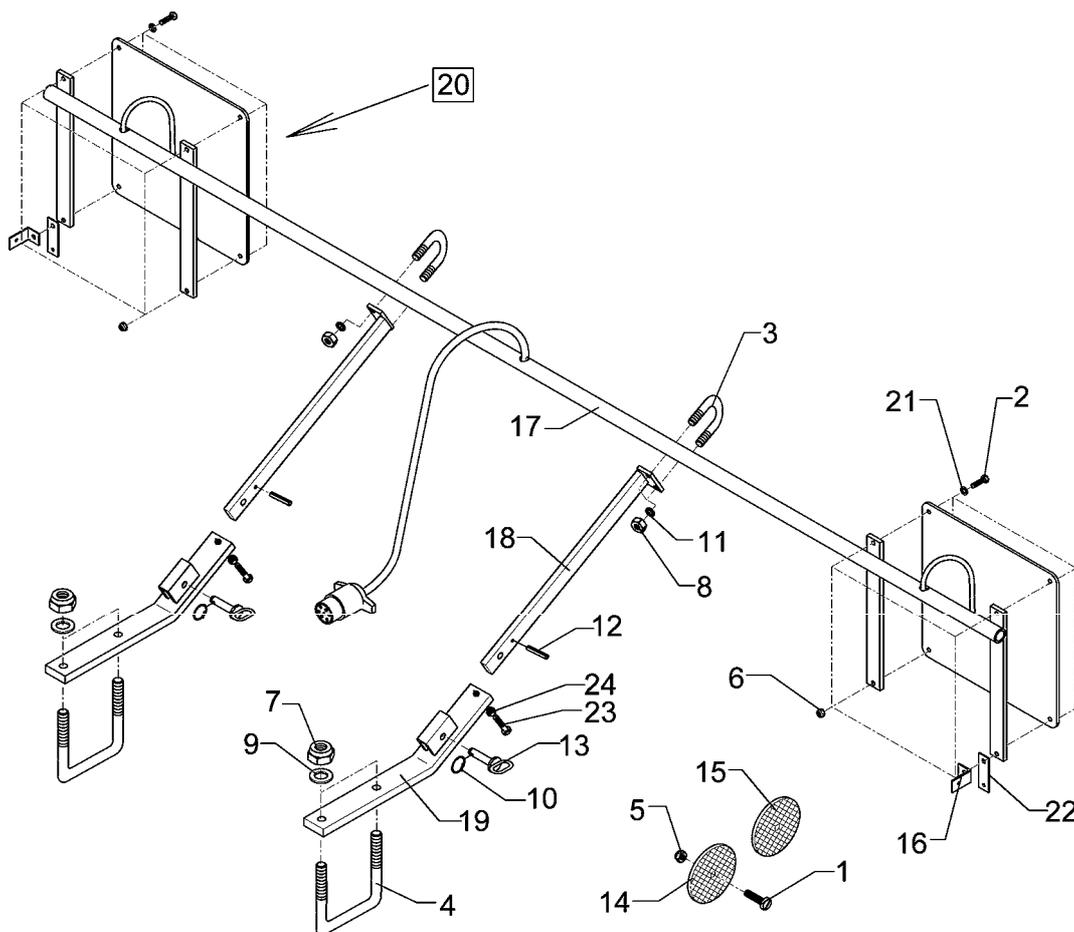

11.04

Pos.	Art.-Nr.	Stk.	Artikeltext / Description		Abmessung
1	301 0301	2	Flachkopfschraube DIN85	Flatheaded bolt	M6x20-4,6 Zn
2	301 7280	8	Sechskantschraube DIN933	Screw	M8x25-8.8 Zn
3	301 7781	2	Bügelsschraube	U-bolt	M10x38x76 DIN3570A Zn
4	301 7800	2	Bügelsschraube	U-bolt	M16/140/185
5	303 0931	2	Sicherungsmutter	Selflocking nut	DIN985-NM6-8 Zn
6	303 0932	8	Sicherungsmutter	Selflocking nut	DIN985-NM8-8 Zn
7	303 0935	4	Sicherungsmutter	Selflocking nut	DIN985-NM16-8 Zn
8	303 0970	4	Sechskantmutter	Nut	M10 DIN934-8
9	305 6143	4	Scheibe	Washer	B17/30x3 DIN125
10	305 8551	2	Federsicherung	Securing clip	41x3
11	305 9900	4	Federring	Spring ring	10 DIN127 Zn
12	309 6054	2	Spannhülse	Expansion bush	6x40-DIN1481 Zn
13	313 7807	2	Bolzen mit Griff	Pin with grip	GB D12x57,5/71
14	321 9921	2	Rückstrahler gelb	Reflector, yellow	8 RA 002014-051
15	321 9922	2	Rückstrahler rot	Reflector, red	8 RA 002 016-111
16	470 1199	2	Halter gebogen	Holder	30x3x90
17	470 1649	1	Leuchtenhalter	Carrier for light	D33,7x4,5x2900
18	470 1664	2	Halter	Holder	40x15x50
19	470 1667	2	Halter	Holder	60x20x520 30GRD
20	570 2007	1	Beleuchtungsanlage hinten	Lighting equipment, rear	Aufsattelung
21	305 8694	9	Scheibe	Washer	A8,4 DIN125-St Zn
22	459 0940	2	Halter	Holder	30x3x90 1x50-D10+7 Zn
23	301 3350	2	Sechskantschraube DIN933	Screw	M12x50-8.8
24	303 1013	2	Sechskantmutter	Nut	M12 DIN934-8 Zn

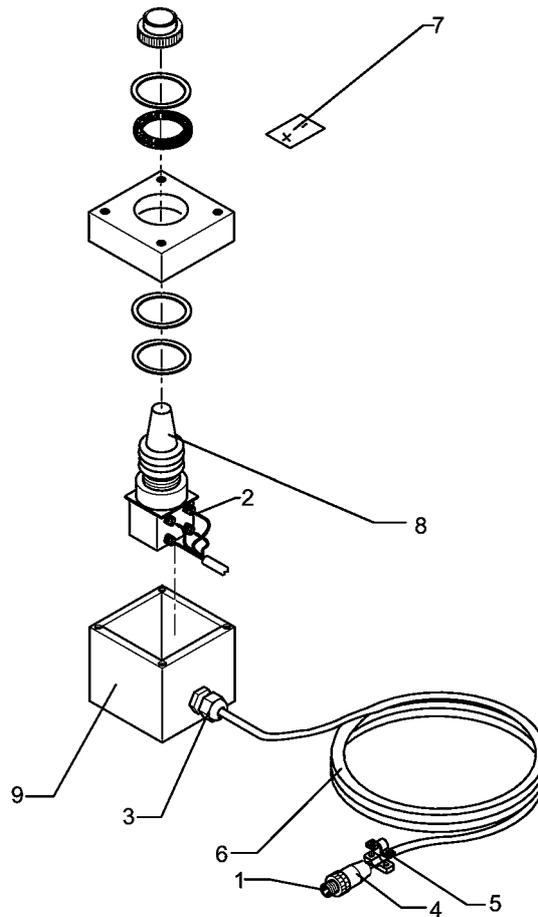

11.04

Pos.	Art.-Nr.	Stk.	Artikeltext / Description	Abmessung	
1	373 0300	4	Stiftkontakt	Pin contact	Typ III 0,75-1,5
2	373 0453	5	Aderendhülse	Multicore cable end	0,75x8 grau
3	373 0766	1	Kabelverschraubung	Screw-type conduit fitting	PG9
4	373 2170	1	Stecker	Plug	4-polig BG-11 IG
5	373 2171	1	Kabelklemme mit Zugentlastung	Clamp	BG-11
6	373 4136	1	Kabel gelb	Cable, yellow	4x0,75
7	390 9002	1	Aufkleber	Label	Joystickbox
8	573 4610	1	Joystickschalter	Joystick-switch	2-Schaltstellungen
9	573 4611	1	Gehäuse	Housing	80x75x75,5 RAL5015

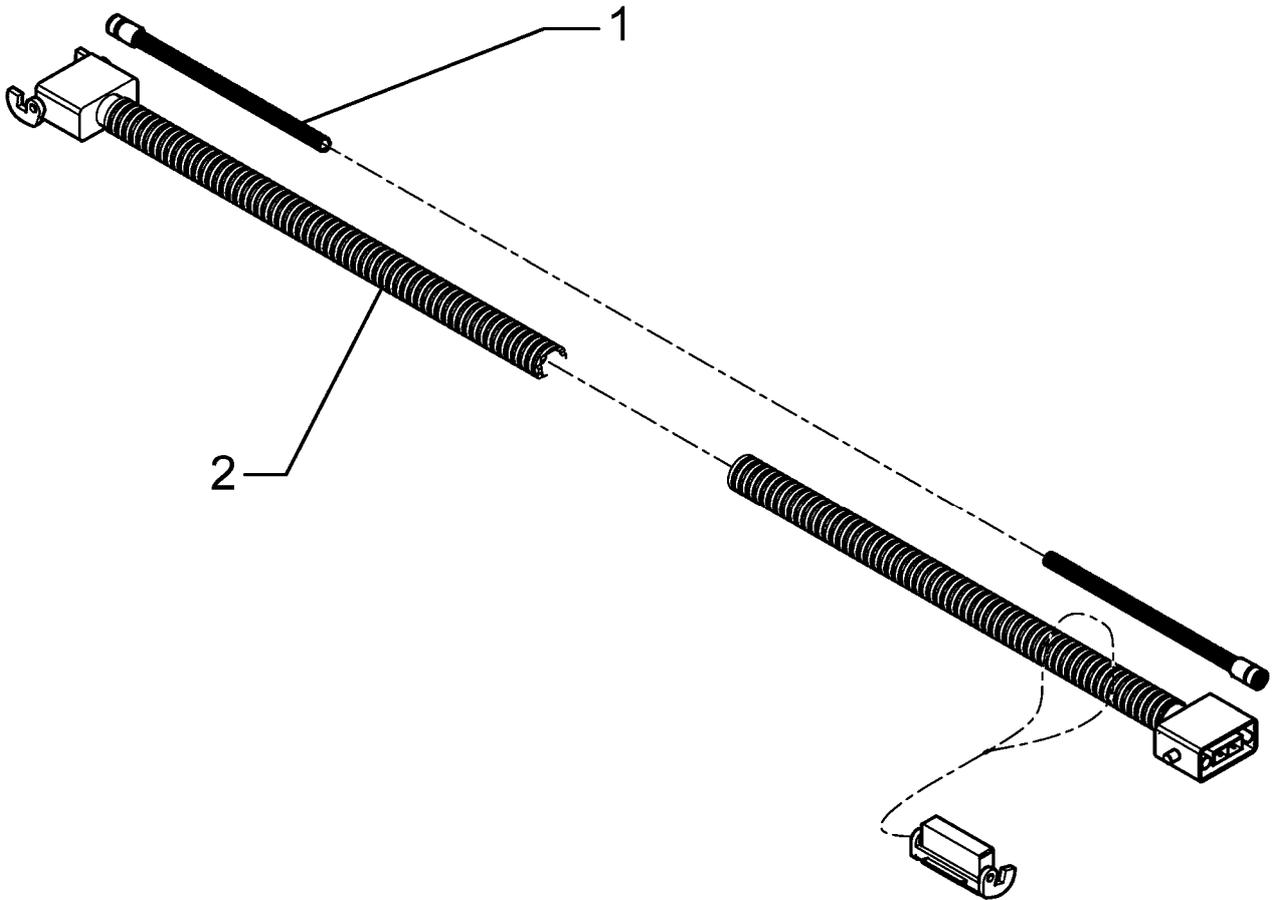

11.04

Pos.	Art.-Nr.	Stk.	Artikeltext / Description	Abmessung
1	573 6170	1	Verbindungsleitung 8-polig	Connection cable
2	573 6163	1	Spannungsverlängerung	Extension cable
				10m mit Schutzkappen
				8m Solitronic

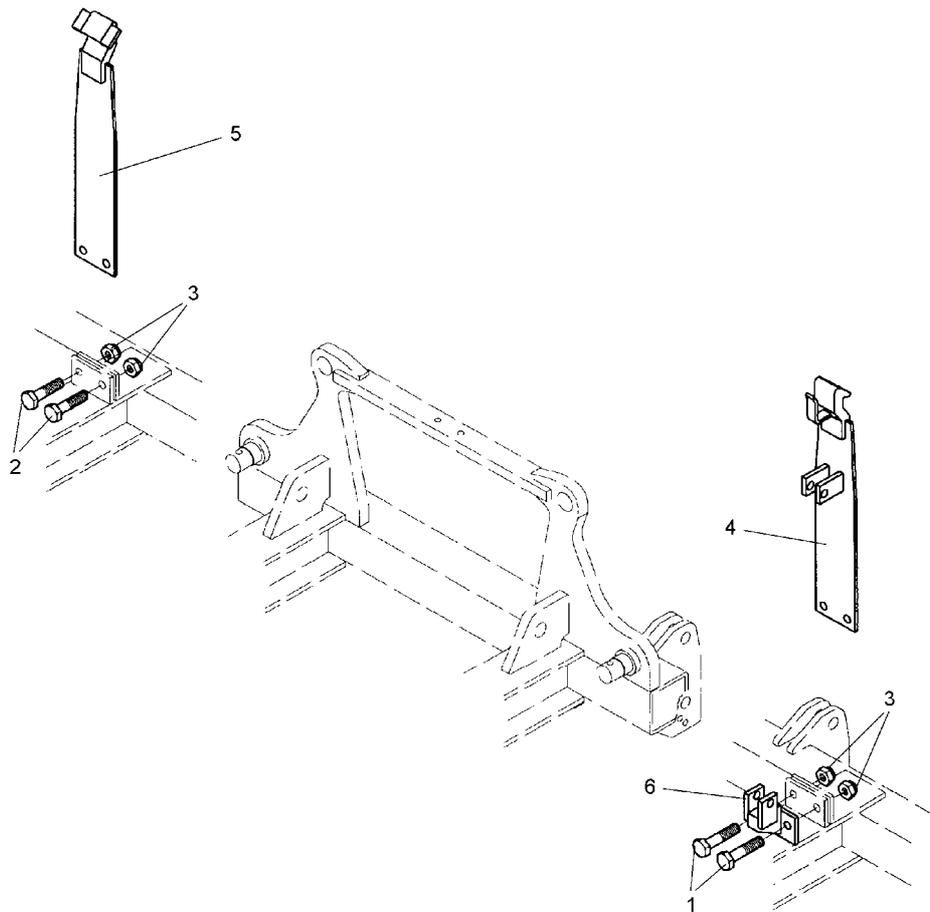

11.04

Pos.	Art.-Nr.	Stk.	Artikeltext / Description		Abmessung
1	301 5385	2	Sechskantschraube spz.	Bolt	M16x55-10.9
2	301 5388	2	Sechskantschraube spz.	Bolt	M16x45-8.8
3	303 0935	4	Sicherungsmutter	Selflocking nut	DIN985-NM16-8 Zn
4	417 8145	1	Blattfeder mit Winkel	Leaf spring with angle	100x6 Smaragd 9-K
5	417 8146	1	Blattfeder mit Lasche	Leaf spring with lashing	100x6 Smaragd 9-K
6	417 8147	1	Halter zum Zylinder	Bracket for ram	Smaragd 9-K

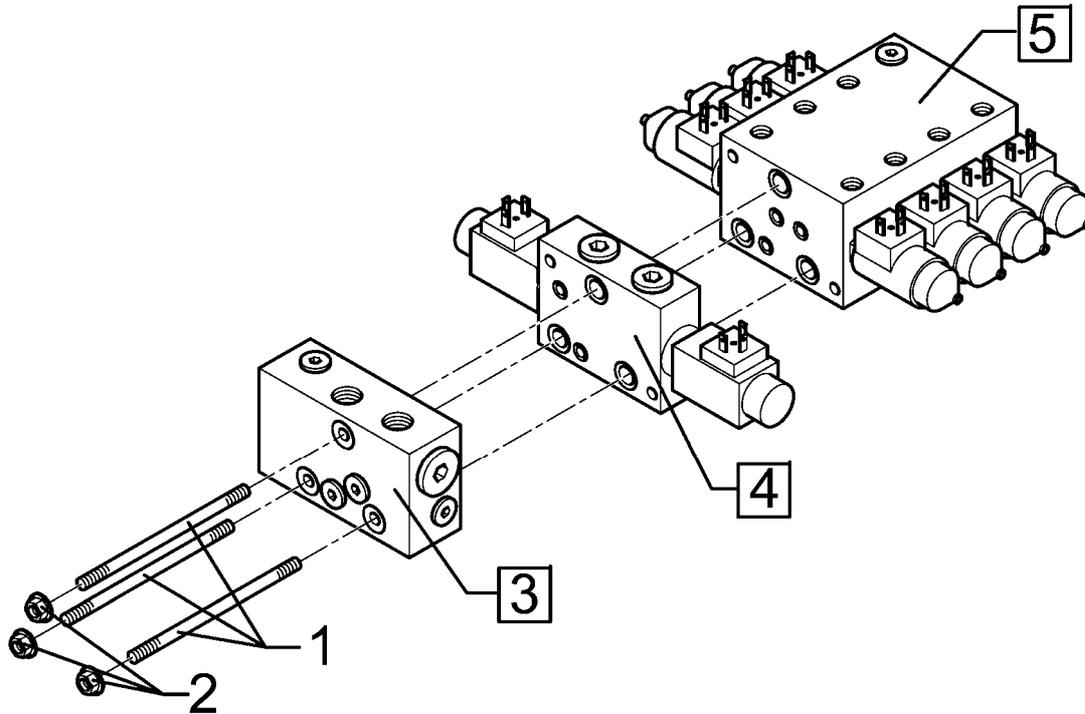

11.04

Pos.	Art.-Nr.	Stk.	Artikeltext / Description		Abmessung
1	301 9915	3	Schaftschraube	Bolt	M8x120 100022943
2	303 0113	3	Dichtmutter	Nut	M8 100280470
3	575 2200	1	Dreiwegedruckwaage	Three-way pressure balance	LU8SSCK-QM22/04
4	575 2201	1	Wegeventil	Valve	6/3 LD8SE4D2525
5	575 2211	1	Sitzventil	Seat valve	SVH04M878SA-OM14G12

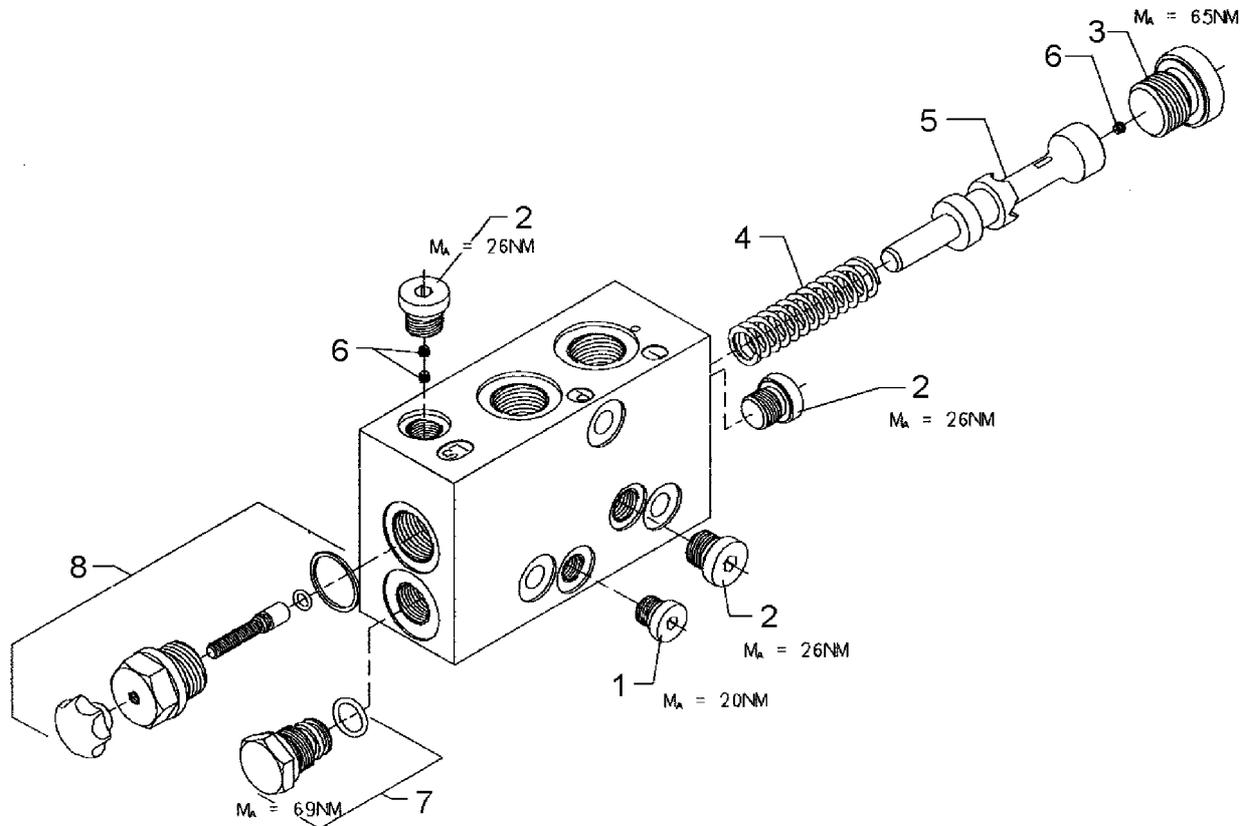

11.04

Pos.	Art.-Nr.	Stk.	Artikeltext / Description	Abmessung	
1	301 9707	1	Verschlußschraube m. Dichtring	Plug	M12x1,5
2	301 9708	3	Verschlußschraube m. Dichtring	Plug	M14x1,5
3	301 9711	1	Verschlußschraube m. Dichtring	Plug	M22x1,5
4	329 8020	1	Druckfeder	Spring	LU08 Bucher
5	475 6068	1	Kolben	Piston	LU08
6	575 1127	3	Einschraubdüse	Nozzle	B M040,8 D D5x3,5
7	575 1128	1	Verschlußschraube, kpl.	Plug, cpl	-
8	575 1129	1	Verschlußschraube, kpl.	Plug, cpl	-

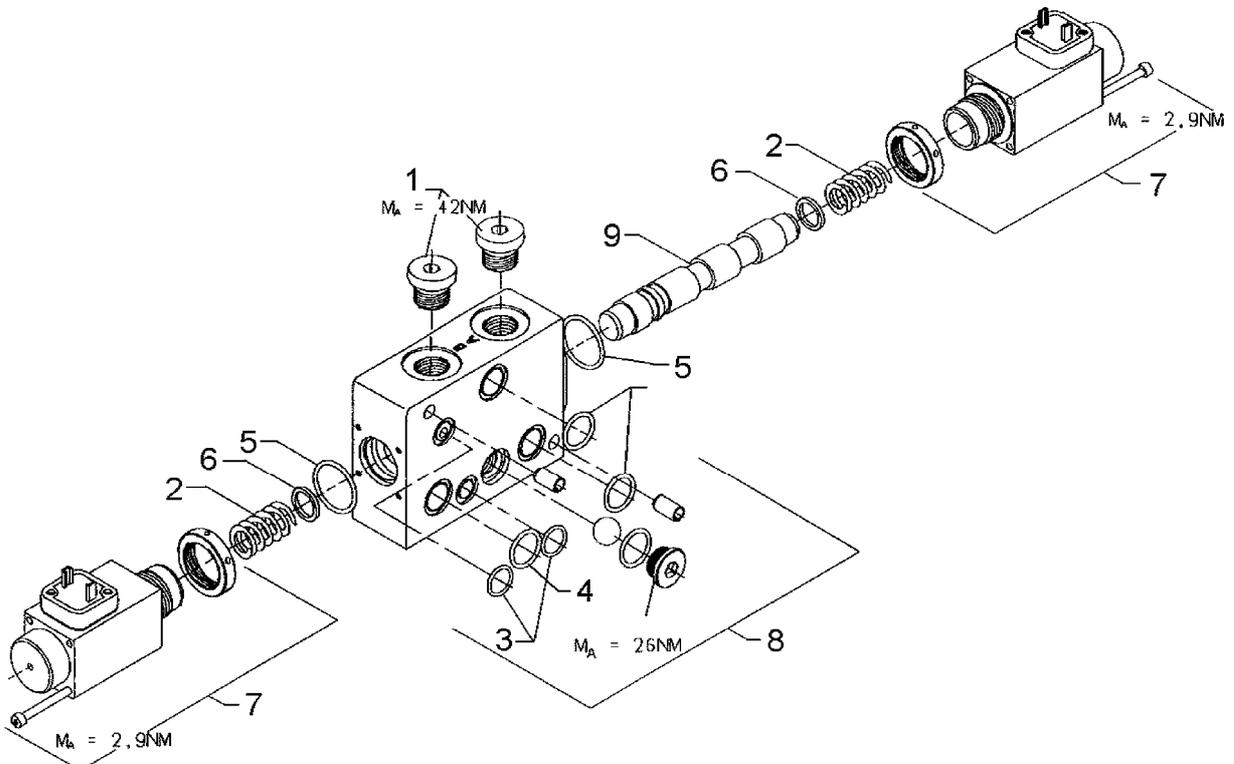

11.04

Pos.	Art.-Nr.	Stk.	Artikeltext / Description	Abmessung
1	301 9710	2	Verschlusschraube m.Dichtring	Plug
2	329 8019	2	Druckfeder	Spring
3	375 1138	2	O-Ring	O-ring
4	375 1149	3	O-Ring	O-ring
5	375 1188	2	O-Ring	O-ring
6	375 1325	2	Scheibe	Washer
7	573 4700	2	Schaltmagnet	Magnet
8	575 1130	1	Einbauteile	Mounting parts
9	575 1131	1	Steuerschieber	Servo spool valve
				M18x1,5
				LD8SE Bucher
				12x2
				16,56x1,78
				24x2,0
				LMX08
				Bucher
				L.8SE/02
				LD08.4D D17x111,4

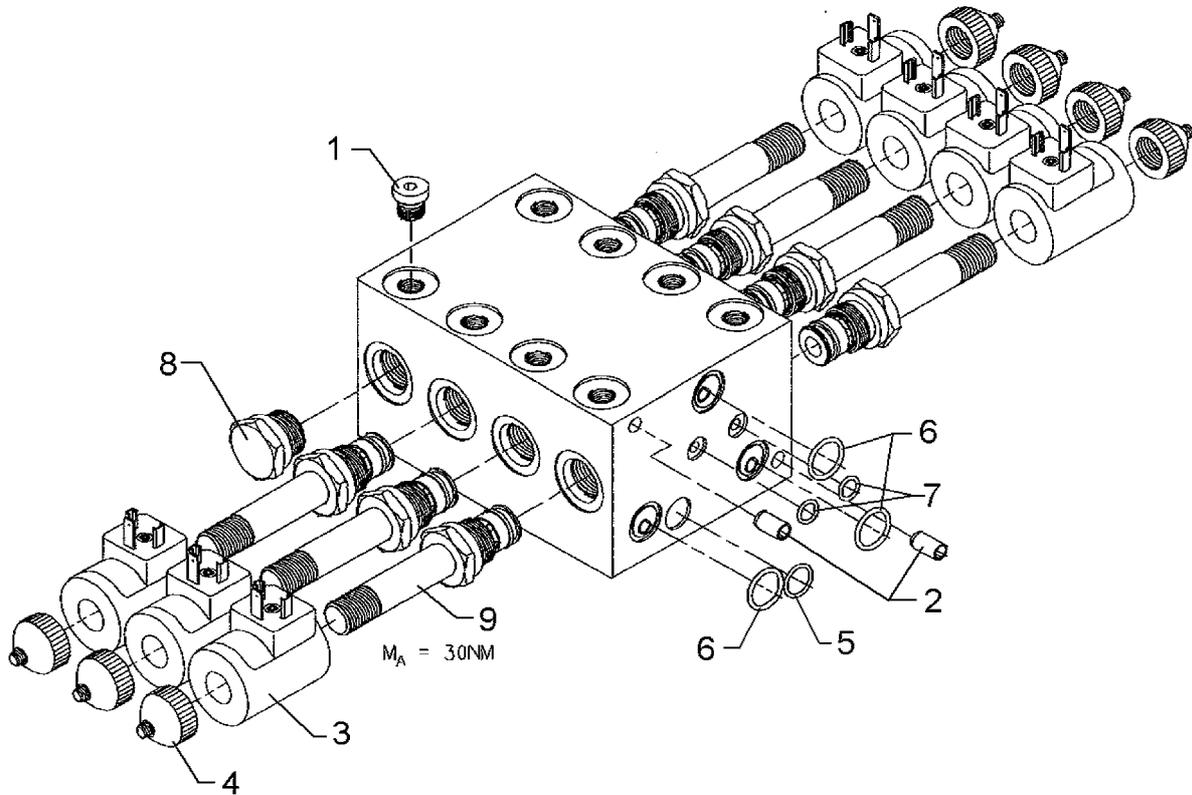

11.04

Pos.	Art.-Nr.	Stk.	Artikeltext / Description	Abmessung	
1	301 9708	1	Verschlußschraube m.Dichtring	Plug	M14x1,5
2	309 3301	2	Spannhülse	Expansion bush	8x12-DIN7346
3	373 4701	7	Magnetspule	Magnet coil	D3612DC27WH
4	373 4702	7	Handnotverstellung Arret.	Hand control, stop	K4-6908
5	375 1118	2	O-Ring	O-ring	8x2
6	375 1138	1	O-Ring	O-ring	12x2
7	375 1149	3	O-Ring	O-ring	16,56x1,78
8	375 5151	1	Verschlußschraube	Plug	MHW-90-2-9
9	575 1132	7	Wege-Sitzventil	Valve	2/2

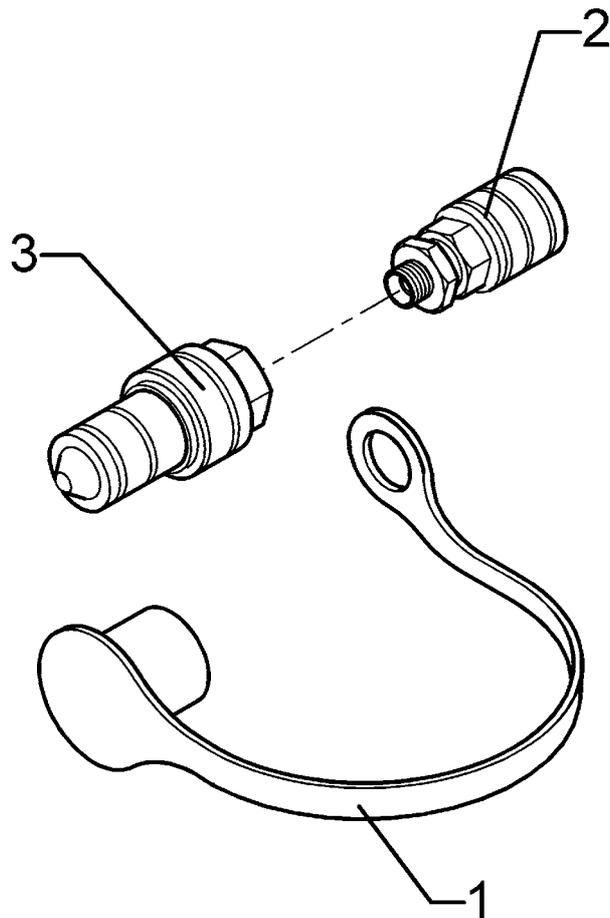

11.04

Pos.	Art.-Nr.	Stk.	Artikeltext / Description	Abmessung
1	375 2165	1	Staubstecker rot	Plastic male probe
2	375 2737	1	SVK-Muffe	SVK-socket
3	375 2741	1	Steckkupplung Kugel	Connection
				BG-3 CEL15 M22x1,5
				K700 12LM18x1,5

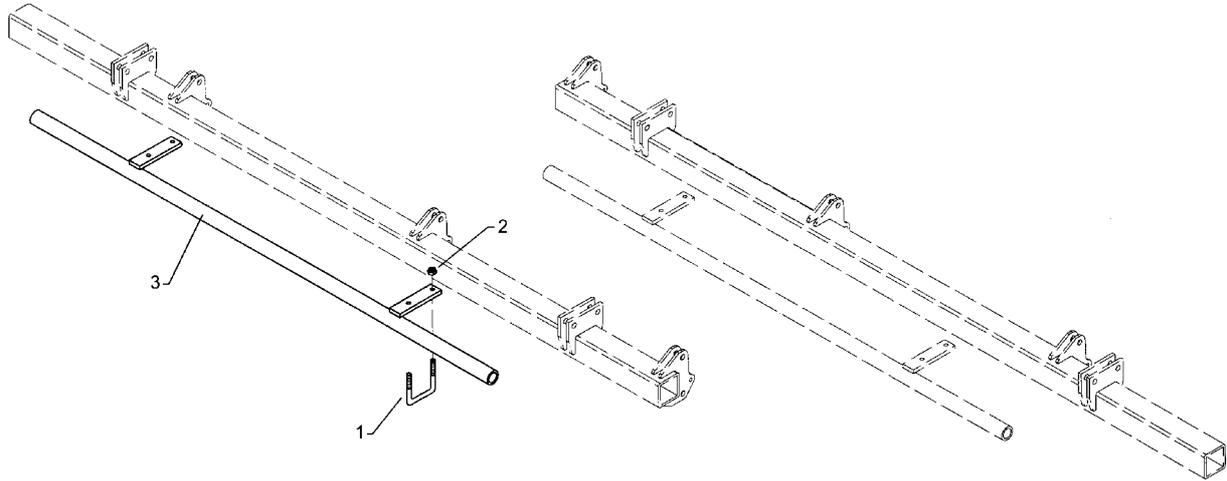

11.04

Pos.	Art.-Nr.	Stk.	Artikeltext / Description		Abmessung
1	301 7785	2	Bügelschraube	U-bolt	M10x80x110
2	303 0933	4	Sicherungsmutter	Selflocking nut	DIN985-NM10-8 Zn
3	475 4366	1	Schlauchhalter	Hose carrier	D42,5x6,3x1740

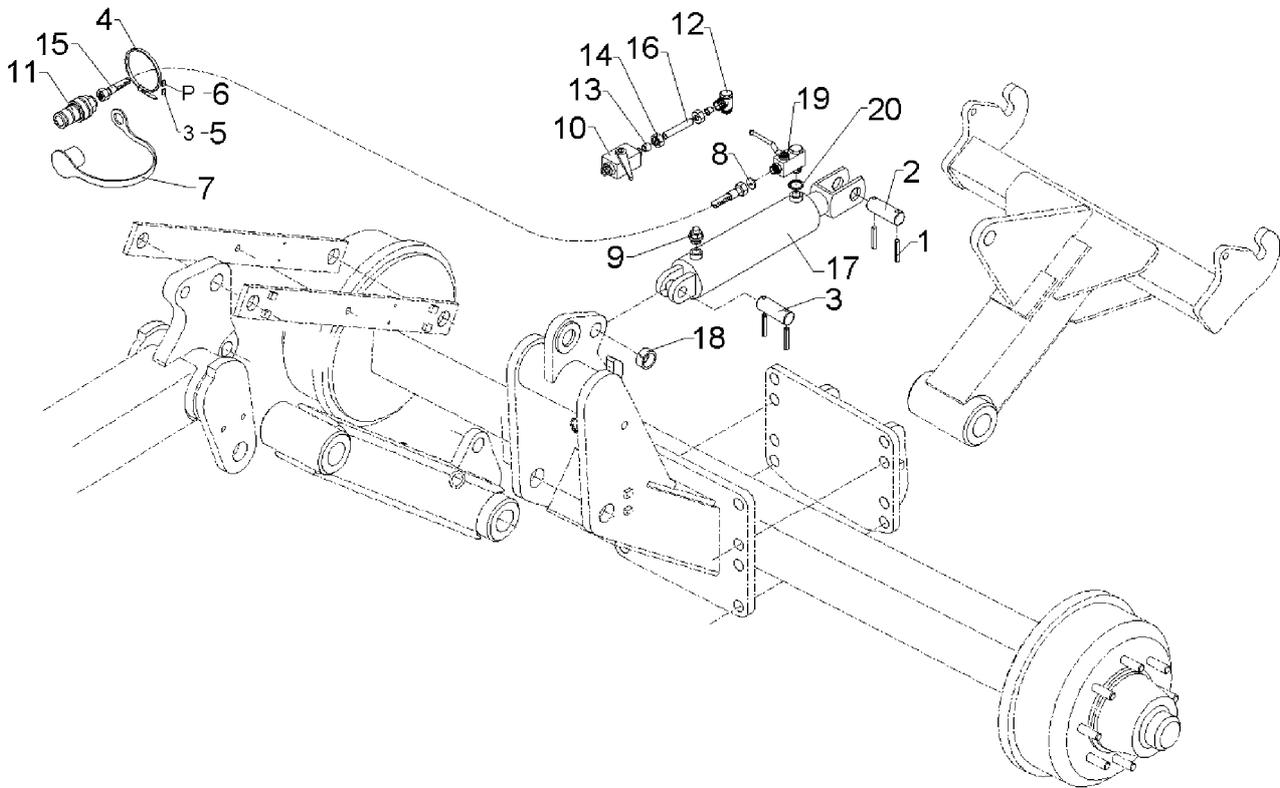

11.04

Pos.	Art.-Nr.	Stk.	Artikeltext / Description		Abmessung
1	309 7000	4	Spannhülse	Expansion bush	8x50-DIN1481 Chrom 8
2	313 3011	1	Bolzen	Pin	BB D30x72/102 Zn
3	313 3012	1	Bolzen	Pin	BB D30x62/92 Zn
4	325 1350	1	Spannband	Strap	6,3x254 VA
5	325 1503	1	EASY-READ Zeichen	EASY-READ sign	3
6	325 1511	1	EASY-READ Zeichen	EASY-READ sign	P
7	375 2121	1	Staubkappe, blau	Cap	D26,5 Bg.3
8	375 2173	1	Drosselplättchen	Throttle plate	D12x1,5 BO 1,5
9	375 2196	1	Be- und Entlüftungsschraube	Vent plug	M18x1,5
10	375 2199	1	Kugelhahn	Valve	BKH 12L-M18x1,5 Zn
11	375 2718	1	SVK-Stecker	SVK-socket	NW10-M18x1,5
12	375 4311	1	Schwenkverschraubung	Union, swivel	x-SWVE12-LM M18x1,5 Zn
13	375 5110	2	Schneidring	Cutting ring	12-L/S Zn WD
14	375 5310	2	Überwurfmutter	Union nut	12L M18x1,5 Zn
15	475 2615	1	Hydraulikschlauch	High-pressure hose	2SN10-1200 M18x1,5
16	475 9900	1	Rohr	Tube	12x2x135
17	575 2356	1	Hydraulikzylinder	Ram	110/50-450
18	317 3417	1	Einspannbuchse mit Preßsitz	Expansion bush	EG30/38x25
19	375 2206	1	Kugelhahn	Valve	HBPA 0602 M18x1,5 Zn DN6
20	375 5081	1	Dichtkantenring	Seal ring	18,2x25,1x5

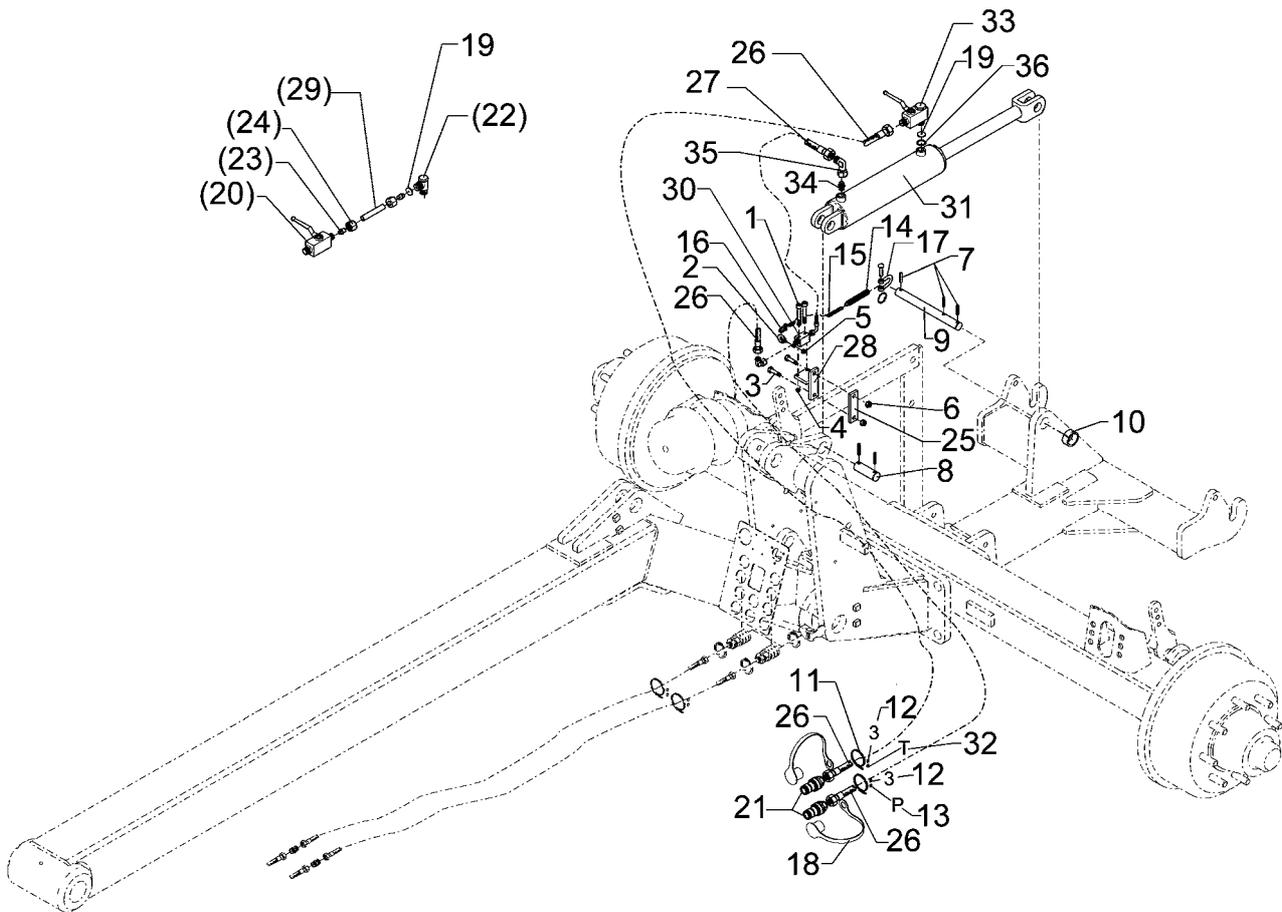

11.04

Pos.	Art.-Nr.	Stk.	Artikeltext / Description	Abmessung	
1	301 0306	2	Flachkopfschraube DIN85	Flatheaded bolt	M6x45-4,6 Zn
2	301 0815	1	Ringschraube	Eye bolt	M8 DIN580 Zn
3	301 3248	2	Sechskantschraube DIN931-A	Bolt	M10x55-8.8 Zn
4	303 0931	2	Sicherungsmutter	Selflocking nut	DIN985-NM6-8 Zn
5	303 0932	1	Sicherungsmutter	Selflocking nut	DIN985-NM8-8 Zn
6	303 0933	2	Sicherungsmutter	Selflocking nut	DIN985-NM10-8 Zn
7	309 7000	5	Spannhülse	Expansion bush	8x50-DIN1481 Chrom 8
8	313 3012	1	Bolzen	Pin	BB D30x62/92 Zn
9	313 3054	1	Bolzen	Pin	D30/25x260 2xD8
10	317 3417	1	Einspannbuchse mit Preßsitz	Expansion bush	EG30/38x25
11	325 1350	1	Spannband	Strap	6,3x254 VA
12	325 1503	1	EASY-READ Zeichen	EASY-READ sign	3
13	325 1511	2	EASY-READ Zeichen	EASY-READ sign	P
14	329 8515	1	Zugfeder	Spring	4,5x22,5x280
15	331 6405	0	Kette	Chain	4x32 DIN763
16	331 8405	1	Schäkel	Shackle	A 0,16 DIN 82101 Zn
17	331 9815	1	Malotte	Shackle	D13-kpl.
18	375 2121	2	Staubkappe, blau	Cap	D26,5 Bg.3
19	375 2173	1	Drosselplättchen	Throttle plate	D12x1,5 BO 1,5
20	375 2199	1	Kugelhahn	Valve	BKH 12L-M18x1,5 Zn
21	375 2718	2	SVK-Stecker	SVK-socket	NW10-M18x1,5
22	375 4311	1	Schwenkverschraubung	Union, swivel	x-SWVE12-LM M18x1,5 Zn
23	375 5110	2	Schneidring	Cutting ring	12-L/S Zn WD
24	375 5310	2	Überwurfmutter	Union nut	12L M18x1,5 Zn
25	459 1007	1	Brücke	Clamp plate	30x8x105 1x80
26	475 2615	2	Hydraulikschlauch	High-pressure hose	2SN10-1200 M18x1,5

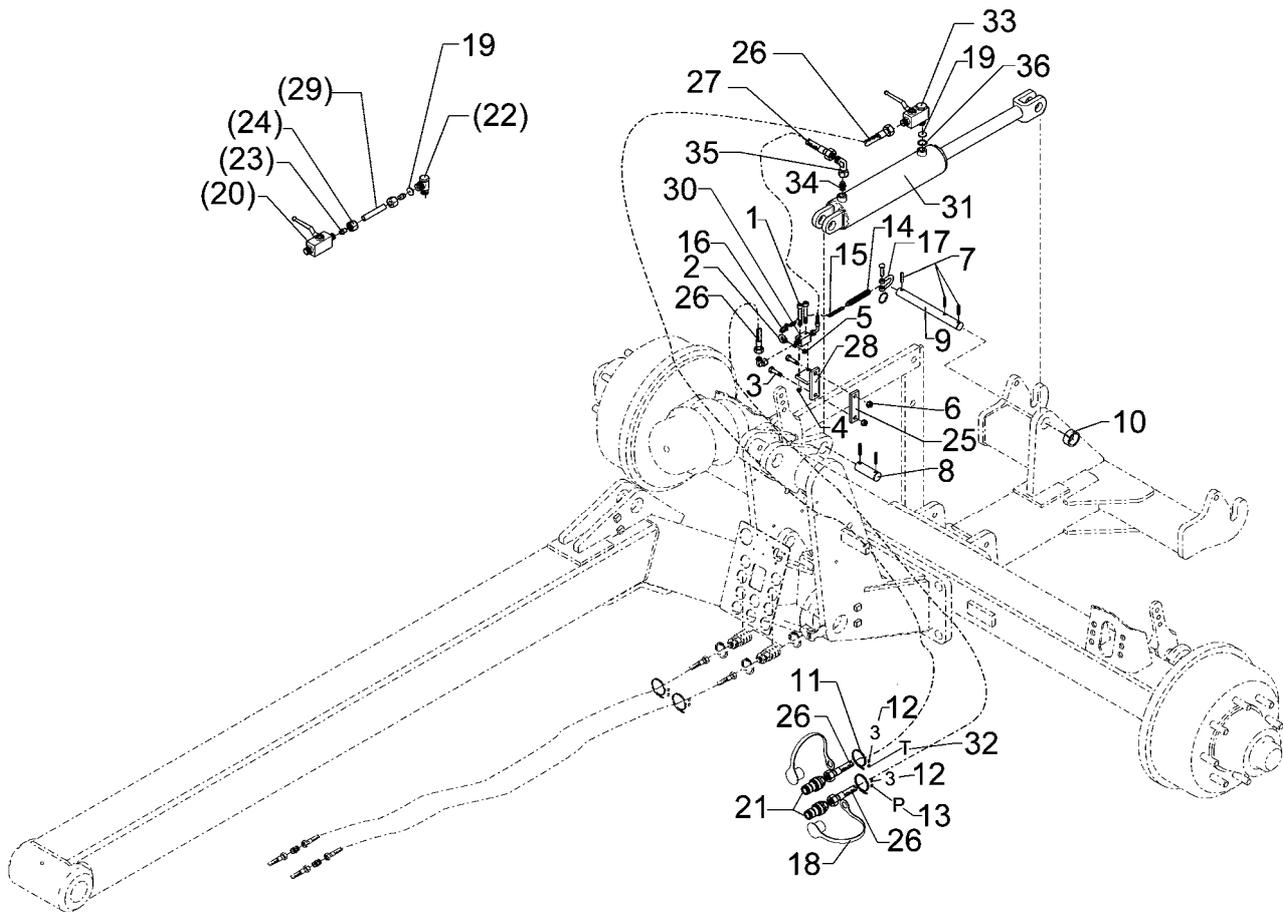

11.04

Pos.	Art.-Nr.	Stk.	Artikeltext / Description	Abmessung	
27	475 2673	1	Hydraulikschlauch	High-pressure hose	2SN 10-400 2xDKOL12L
28	475 4386	1	Halter für Hubbegrenzer	Carrier	30x8x105
29	475 9900	1	Rohr	Tube	12x2x135
30	575 2145	1	Hubbegrenzer Hebel links	Raise limiter	HBS12LM M18x1,5 ZN
31	575 2356	1	Hydraulikzylinder	Ram	110/50-450
32	325 1512	1	EASY-READ Zeichen	EASY-READ sign	T
33	375 2206	1	Kugelhahn	Valve	HBPA 0602 M18x1,5 Zn DN6
34	375 4020	1	Einschraubverschraubung	Nipple	x-GE12-LM M18x1,5 Zn
35	375 4500	2	Einstellbare W-Verschraubung	Adjustable angle union	x-evW12-LM DKO24° M18x1,5
36	375 5081	1	Dichtkantenring	Seal ring	18,2x25,1x5

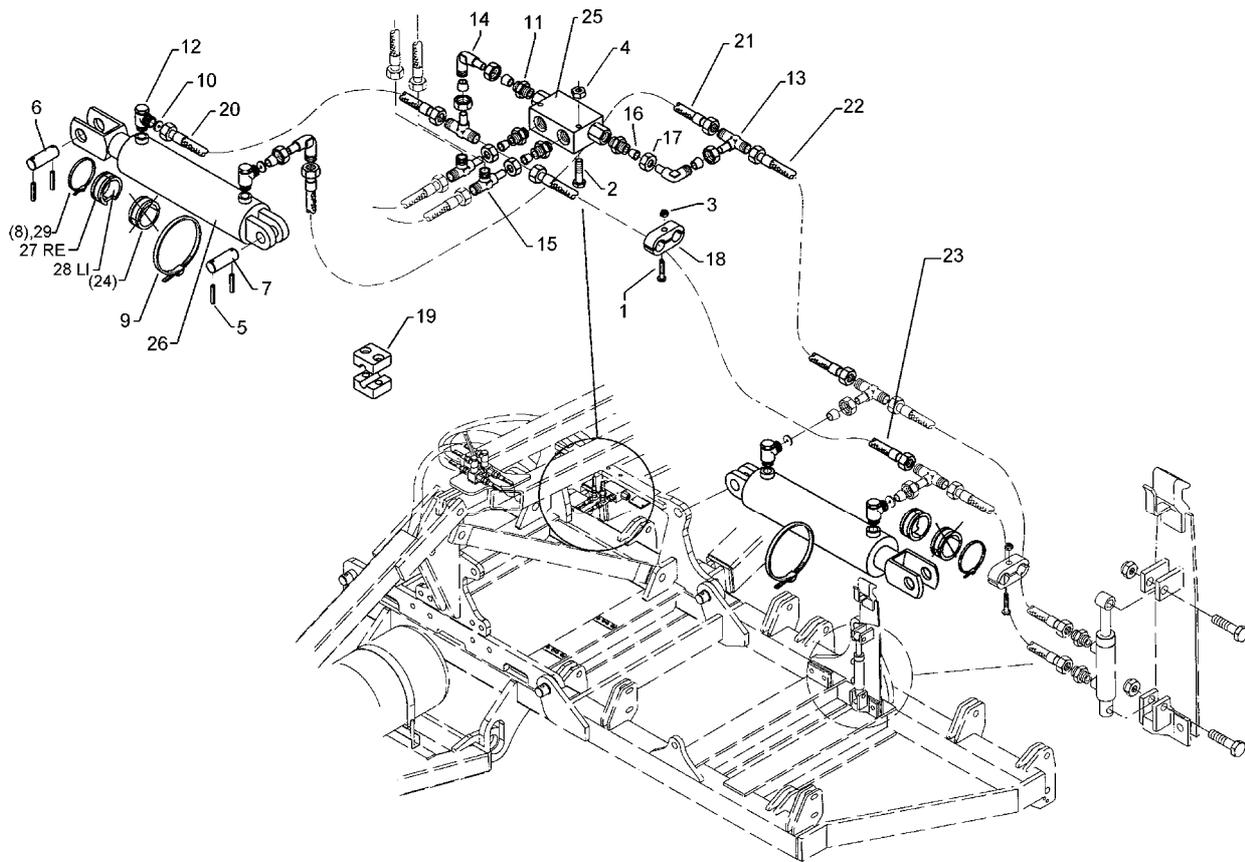

11.04

Pos.	Art.-Nr.	Stk.	Artikeltext / Description		Abmessung
1	301 0306	1	Flachkopfschraube DIN85	Flatheaded bolt	M6x45-4,6 Zn
2	301 2998	2	Sechskantschraube DIN931-A	Bolt	M5x40-8.8 Zn
3	303 0931	1	Sicherungsmutter	Selflocking nut	DIN985-NM6-8 Zn
4	303 0967	2	Sechskantmutter	Nut	M5 DIN934-8 Zn
5	309 7000	8	Spannhülse	Expansion bush	8x50-DIN1481 Chrom 8
6	313 3011	2	Bolzen	Pin	BB D30x72/102 Zn
7	313 3012	2	Bolzen	Pin	BB D30x62/92 Zn
8	325 1165	2	Schlauchschelle	Hose clip	60/80
9	325 1185	2	Schlauchklemme	Hose clip	110-130 Zn Norma
10	375 2172	2	Drosselplättchen	Throttle plate	D12x1,5 BO 1,0
11	375 4038	4	Einschraubverschraubung	Nipple	GE 12-LR R1/4
12	375 4311	4	Schwenkverschraubung	Union, swivel	x-SWVE12-LM M18x1,5 Zn
13	375 4490	2	Einstellbare T-Verschraubung	T-adjustable T-union	x-evT12-LM DKO24° M18x1,5
14	375 4500	3	Einstellbare W-Verschraubung	Adjustable angle union	x-evW12-LM DKO24° M18x1,5
15	375 4550	2	Einstellbare L-Verschraubung	L-adjustable T-union	x-evL12-L DKO24° M18x1,5
16	375 5110	8	Schneidring	Cutting ring	12-L/S Zn WD
17	375 5310	2	Überwurfmutter	Union nut	12L M18x1,5 Zn
18	375 9852	2	Schelle	Clamp	LNG-19/19PP 1/2
20	475 2597	1	Hydraulikschlauch	High-pressure hose	2SN10-700 DKOL12/DKOL12
21	475 2673	1	Hydraulikschlauch	High-pressure hose	2SN 10-400 2xDKOL12L
22	475 2613	1	Hydraulikschlauch	High-pressure hose	2SN10-500 M18x1,5
23	475 2615	1	Hydraulikschlauch	High-pressure hose	2SN10-1200 M18x1,5
24	475 6101	4	Distanzblock	Spacer block	D75/48,5x22
25	575 2161	1	Rückschlagventil	Nonreturn valve	RDP 06 1/4
26	575 2356	2	Hydraulikzylinder	Ram	110/50-450
27	475 6107	2	Distanzblock	Spacer block	D100/48,5x22 LI

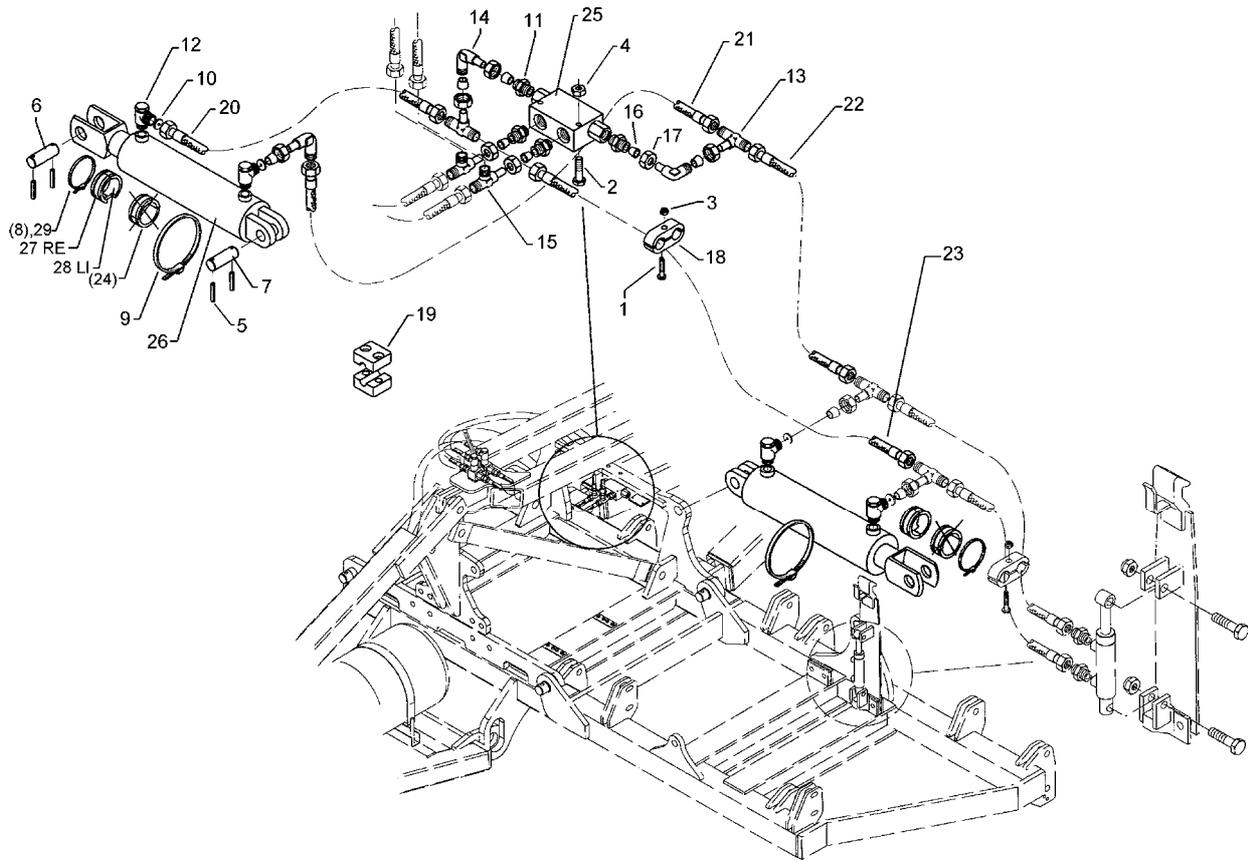

11.04

Pos.	Art.-Nr.	Stk.	Artikeltext / Description		Abmessung
28	475 6106	2	Distanzblock	Spacer block	D100/48,5x22 RE
29	325 1170	2	Schlauchschelle	Hose clip	50-101 S 5600
30	375 2205	2	Verbindung	Connection	DKOL12/IGM 16x1,5
31	375 2501	2	Drosselscheibe, Dreibein	Restrictor washer	0,9
32	375 4010	2	Einschraubverschraubung	Nipple	x-GE12-LM M16x1,5 Zn
33	375 4660	2	Blindbutzen	Blind plug	BUZ12-L

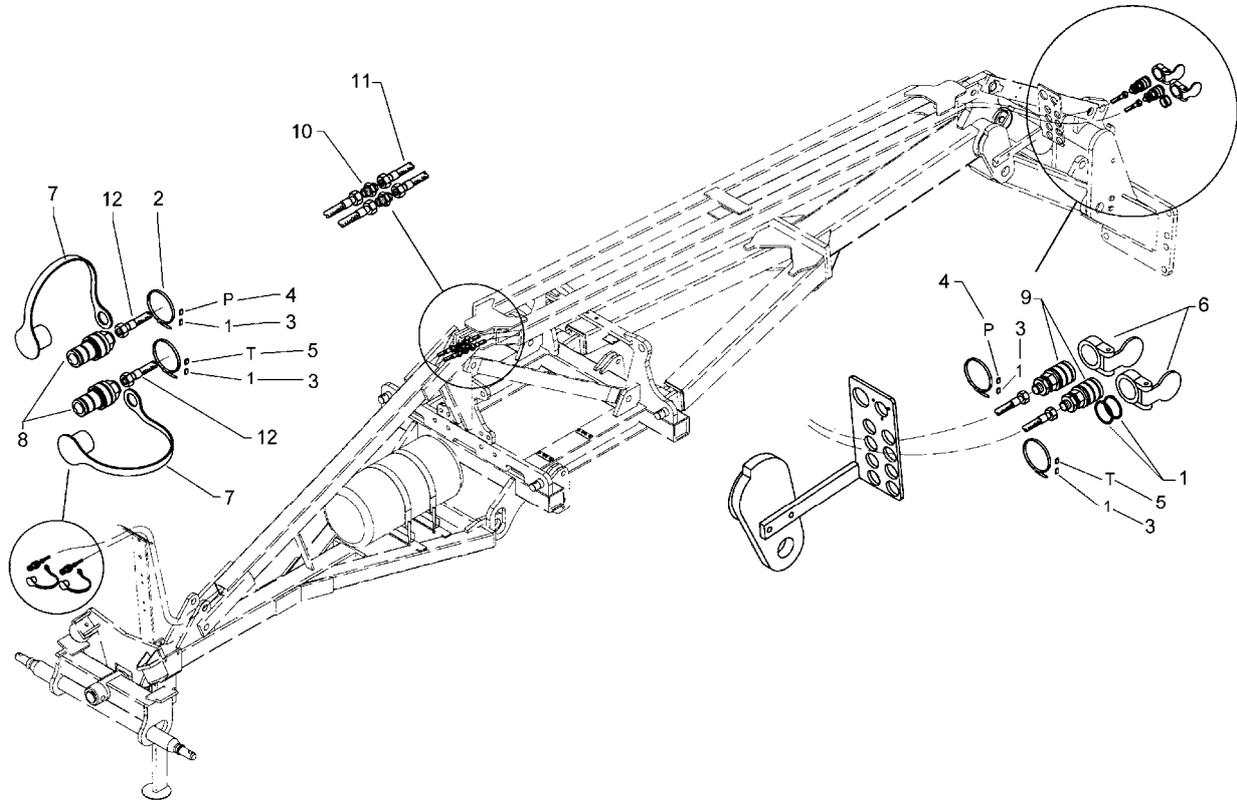

11.04

Pos.	Art.-Nr.	Stk.	Artikeltext / Description		Abmessung
1	305 8871	4	Sicherungsring	Securing ring	38x1,75 DIN471 Zn
2	325 1350	4	Spannband	Strap	6,3x254 VA
3	325 1501	4	EASY-READ Zeichen	EASY-READ sign	1
4	325 1511	2	EASY-READ Zeichen	EASY-READ sign	P
5	325 1512	2	EASY-READ Zeichen	EASY-READ sign	T
6	375 2105	2	Staubschutzklappe rot	Dust protection flap	BG 3 D38
7	375 2166	2	Staubkappe, rot	Cap, red	D26,5
8	375 2718	2	SVK-Stecker	SVK-socket	NW10-M18x1,5
9	375 2735	2	SVK-Muffe	SVK-socket	CEL12 M18x1,5 BG3
10	375 4110	2	Gerade Verschraubung	Nipple	x-G12-L M18x1,5
11	475 2500	2	Hydraulikschlauch	High-pressure hose	2SN08-4400-DKOL12
12	475 2501	2	Hydraulikschlauch	High-pressure hose	2SN08-5000-DKOL12

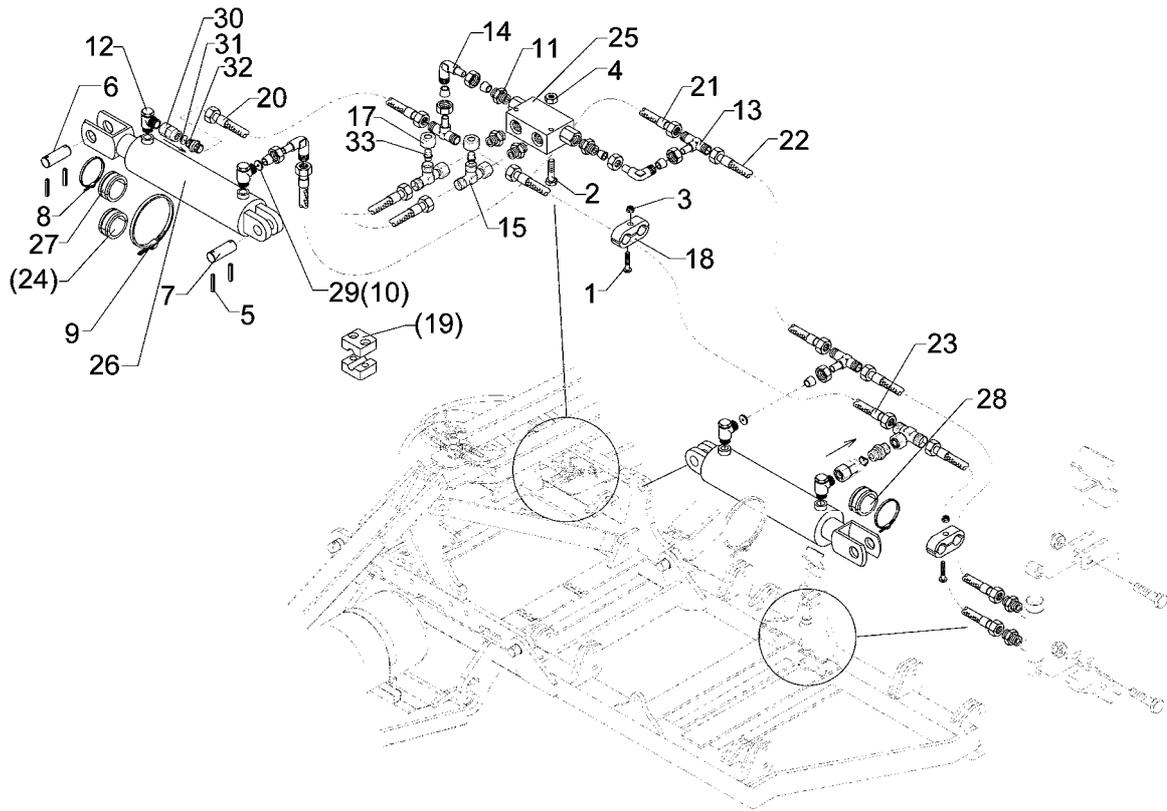

11.04

Pos.	Art.-Nr.	Stk.	Artikeltext / Description		Abmessung
1	301 0306	1	Flachkopfschraube DIN85	Flatheaded bolt	M6x45-4,6 Zn
2	301 2998	2	Sechskantschraube DIN931-A	Bolt	M5x40-8.8 Zn
3	303 0931	1	Sicherungsmutter	Selflocking nut	DIN985-NM6-8 Zn
4	303 0967	2	Sechskantmutter	Nut	M5 DIN934-8 Zn
5	309 7000	8	Spannhülse	Expansion bush	8x50-DIN1481 Chrom 8
6	313 3011	2	Bolzen	Pin	BB D30x72/102 Zn
7	313 3012	2	Bolzen	Pin	BB D30x62/92 Zn
8	325 1165	2	Schlauchschelle	Hose clip	60/80
9	325 1181	2	Schlauchklemme	Hose clip	TORRO 90-110/12-C7W4
10	375 2172	2	Drosselplättchen	Throttle plate	D12x1,5 BO 1,0
11	375 4038	4	Einschraubverschraubung	Nipple	GE 12-LR R1/4
12	375 4311	4	Schwenkverschraubung	Union, swivel	x-SWVE12-LM M18x1,5 Zn
13	375 4490	2	Einstellbare T-Verschraubung	T-adjustable T-union	x-evT12-LM DKO24° M18x1,5
14	375 4500	4	Einstellbare W-Verschraubung	Adjustable angle union	x-evW12-LM DKO24° M18x1,5
15	375 4550	2	Einstellbare L-Verschraubung	L-adjustable T-union	x-evL12-L DKO24° M18x1,5
16	375 5110	8	Schneidring	Cutting ring	12-L/S Zn WD
17	375 5310	2	Überwurfmutter	Union nut	12L M18x1,5 Zn
18	375 9852	2	Schelle	Clamp	LNG-19/19PP 1/2
19	375 9961	8	Schellenkörper	Clamp	1/2x215 PP
20	475 2597	1	Hydraulikschlauch	High-pressure hose	2SN10-700 DKOL12/DKOL12
21	475 2673	1	Hydraulikschlauch	High-pressure hose	2SN 10-400 2xDKOL12L
22	475 2613	1	Hydraulikschlauch	High-pressure hose	2SN10-500 M18x1,5
23	475 2615	1	Hydraulikschlauch	High-pressure hose	2SN10-1200 M18x1,5
24	475 6100	4	Distanzblock	Spacer block	D70/43,5x32
25	575 2161	1	Rückschlagventil	Nonreturn valve	RDP 06 1/4
26	575 2355	2	Hydraulikzylinder	Ram	DZ90/45-450

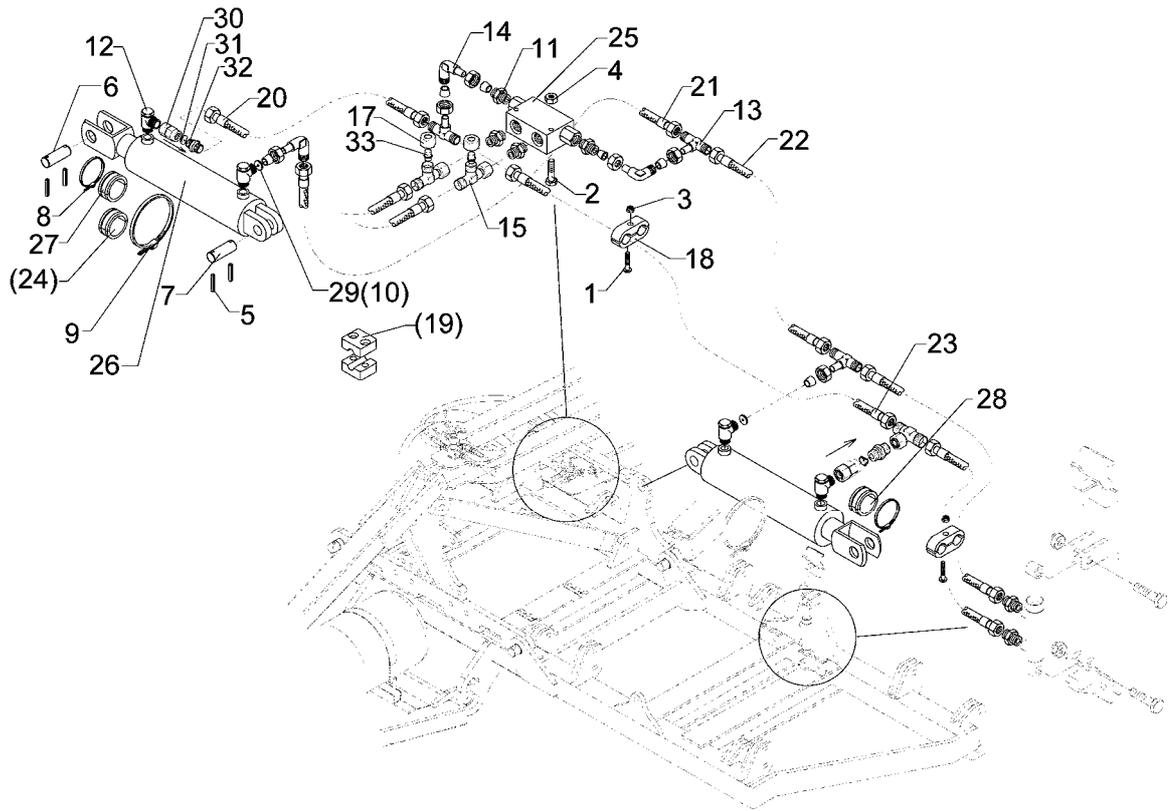

11.04

Pos.	Art.-Nr.	Stk.	Artikeltext / Description	Abmessung
27	475 6104	2	Distanzblock	Spacer block
28	475 6105	2	Distanzblock	Spacer block
				D95/43,5x32 RE
				D95/43,5x32 LI

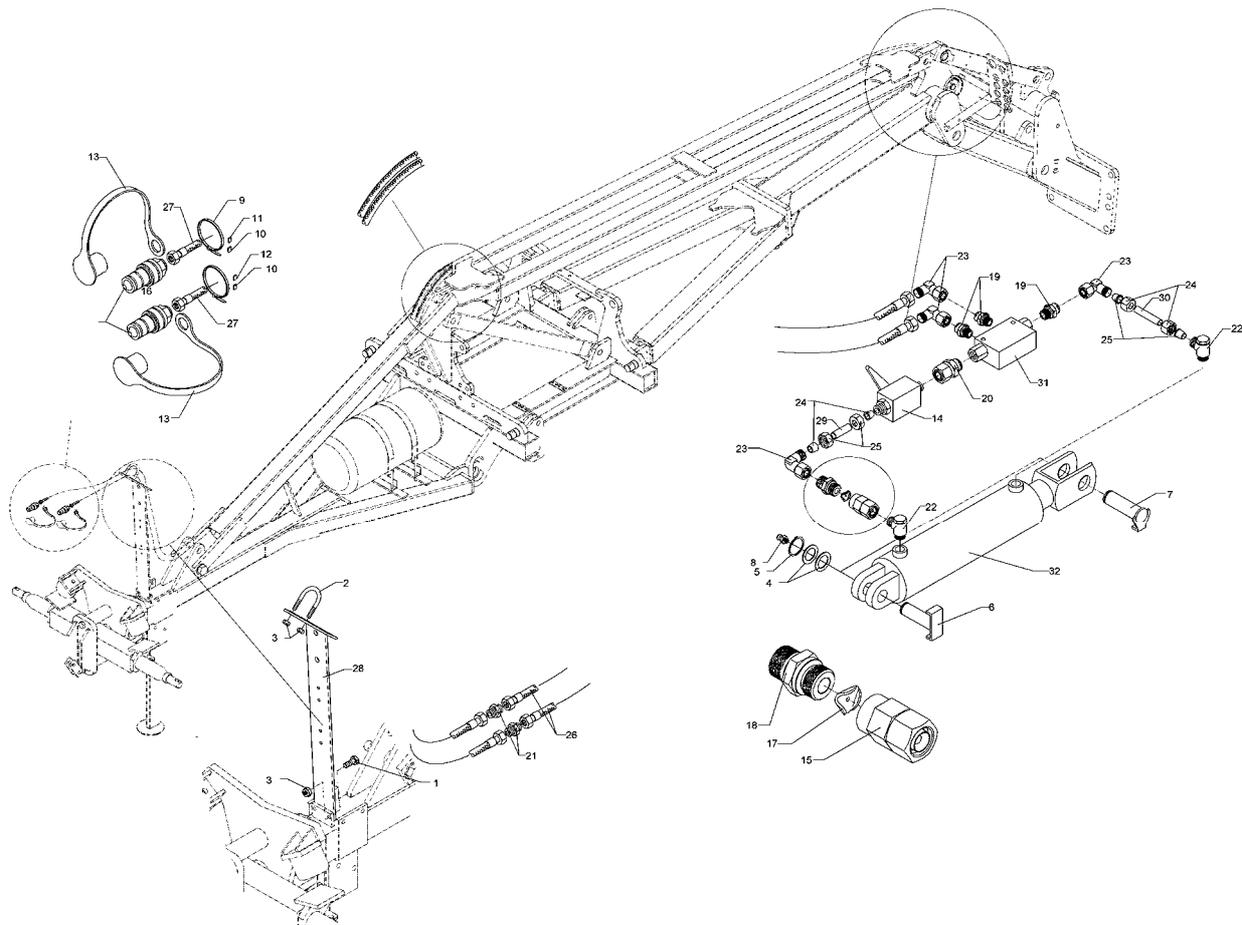

11.04

Pos.	Art.-Nr.	Stk.	Artikeltext / Description		Abmessung
1	301 3224	2	Sechskantschraube DIN933	Screw	M10x30-8.8
2	301 7782	1	Bügelschraube	U-bolt	M10x62x60
3	303 0933	4	Sicherungsmutter	Selflocking nut	DIN985-NM10-8 Zn
4	305 2050	6	Paßscheibe	Shim	30x42x1,0 DIN988
5	305 8867	2	Sicherungsring	Securing ring	30x2 DIN471 Zn
6	313 3017	1	Bolzen mit Verdrehsicherung	Pin with stop	LN D30/31x62/84
7	313 3023	1	Bolzen mit Verdrehsicherung	Pin with stop	UN D30/72x62/84
8	323 6348	2	Schmiernippel	Grease nipple	AM10x1 DIN71412
9	325 1350	2	Spannband	Strap	6,3x254 VA
10	325 1502	2	EASY-READ Zeichen	EASY-READ sign	2
11	325 1511	1	EASY-READ Zeichen	EASY-READ sign	P
12	325 1512	1	EASY-READ Zeichen	EASY-READ sign	T
13	375 2120	2	Staubkappe, grün	Cap	D26,5 Bg.3
14	375 2199	1	Kugelhahn	Valve	BKH 12L-M18x1,5 Zn
15	375 2205	1	Verbindung	Connection	DKOL12/IGM 16x1,5
16	375 2718	2	SVK-Stecker	SVK-socket	NW10-M18x1,5
17	375 2509	1	Drosselscheibe	Restrictor washer	1,7
18	375 4010	1	Einschraubverschraubung	Nipple	x-GE12-LM M16x1,5 Zn
19	375 4038	3	Einschraubverschraubung	Nipple	GE 12-LR R1/4
20	375 4711	1	Stutzen	Stud	x-evGE-12-ED 1/4 DKO 24°
21	375 4110	2	Gerade Verschraubung	Nipple	x-G12-L M18x1,5
22	375 4311	2	Schwenkverschraubung	Union, swivel	x-SWVE12-LM M18x1,5 Zn
23	375 4500	4	Einstellbare W-Verschraubung	Adjustable angle union	x-evW12-LM DKO24° M18x1,5
24	375 5110	4	Schneidring	Cutting ring	12-L/S Zn WD
25	375 5310	4	Überwurfmutter	Union nut	12L M18x1,5 Zn
26	475 2506	2	Hydraulikschlauch	High-pressure hose	2SN08-6300-DKOL12

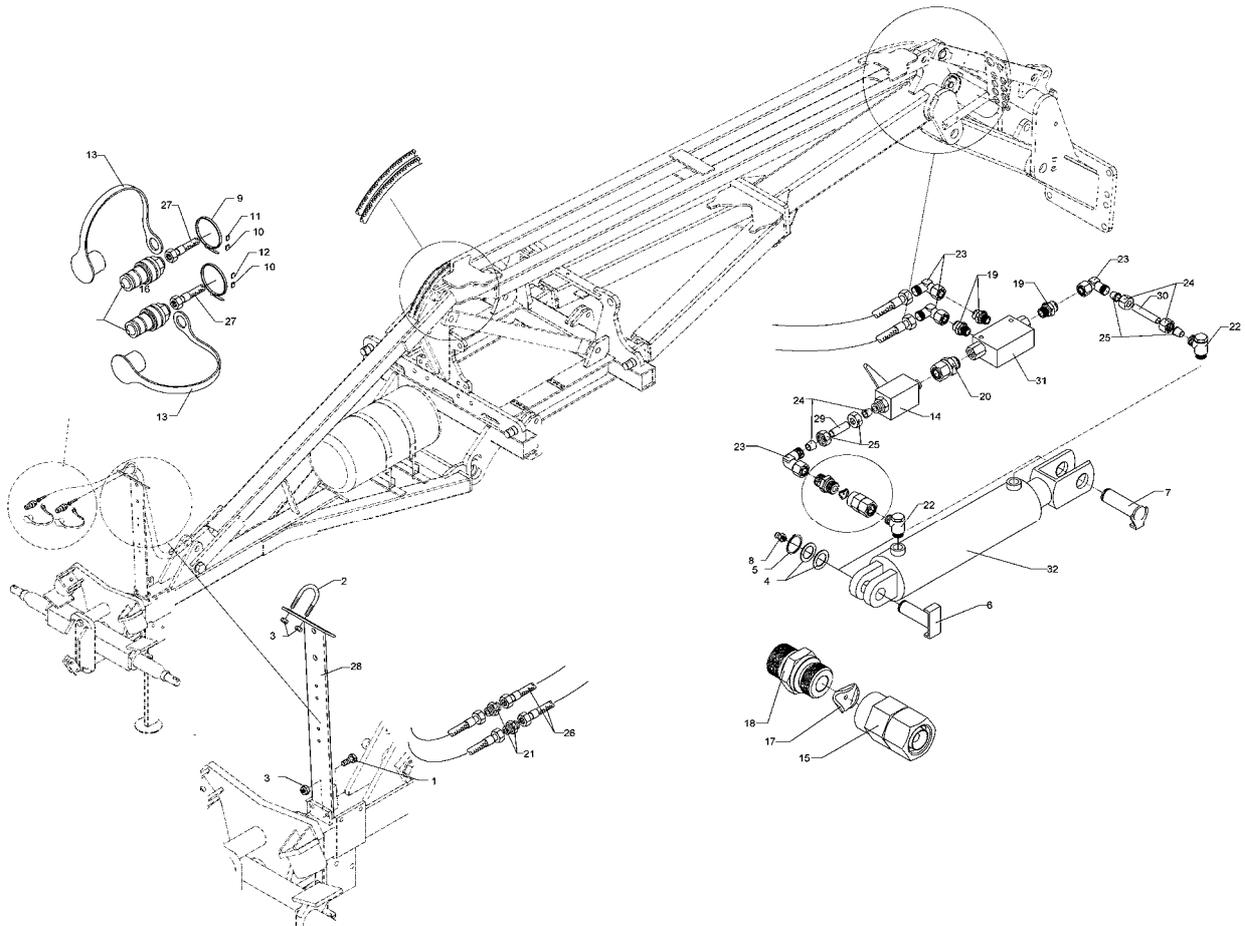

11.04

Pos.	Art.-Nr.	Stk.	Artikeltext / Description		Abmessung
27	475 2656	2	Hydraulikschlauch	High-pressure hose	1SN08-1800 M18x1,5 DKL
28	475 4361	1	Schlauchhalter	Hose carrier	80x8x700 4xD12
29	475 8914	1	Rohr	Tube	12x2x35
30	475 9907	1	Rohr	Tube	12x2x60
31	575 2161	1	Rückschlagventil	Nonreturn valve	RDP 06 1/4
32	575 2359	1	Hydraulikzylinder mit Gabel	Ram	100/40-245-515-D30

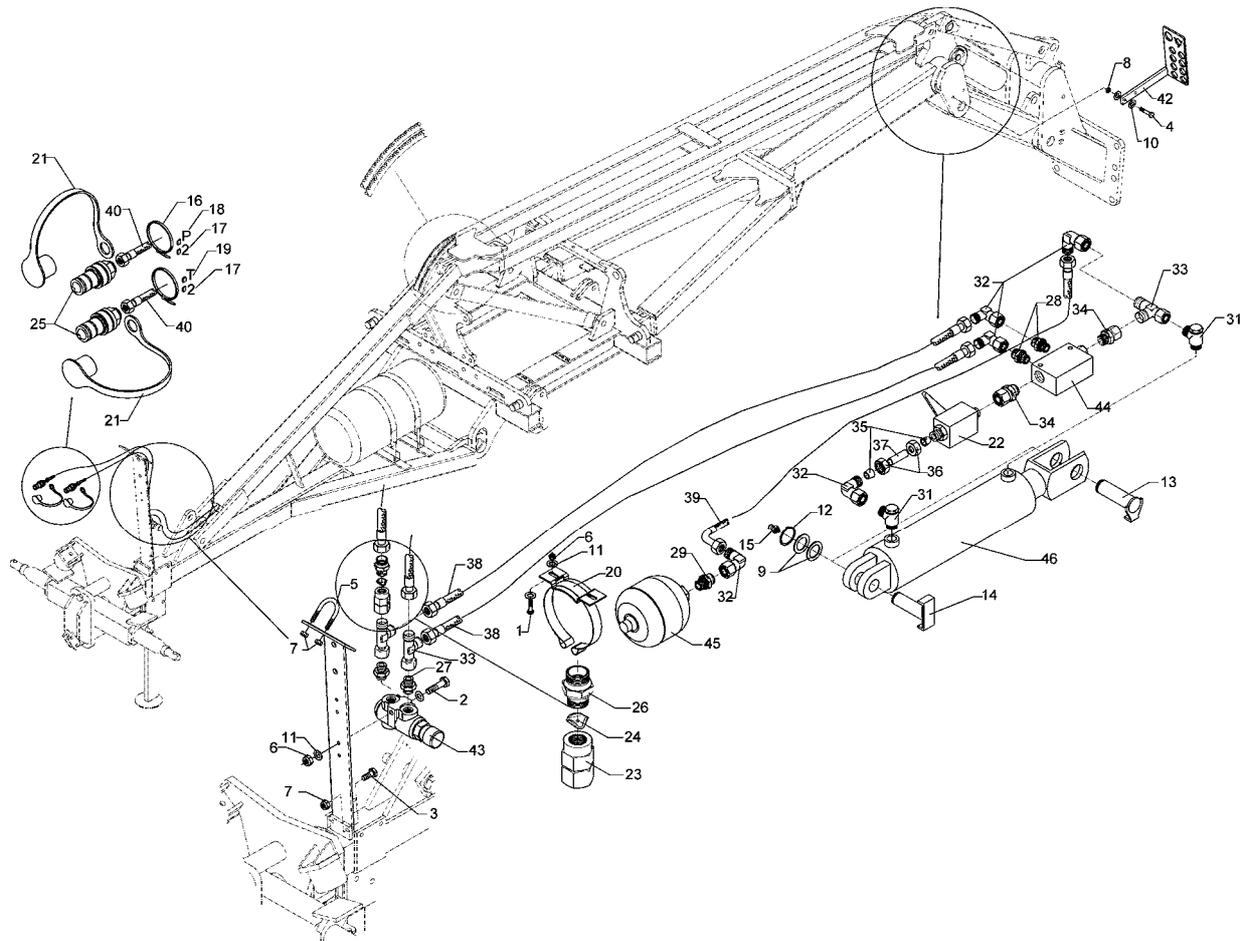

11.04

Pos.	Art.-Nr.	Stk.	Artikeltext / Description		Abmessung
1	301 3073	2	Sechskantschraube DIN931-A	Bolt	M8x45-8.8 Zn
2	301 3081	1	Sechskantschraube DIN931-A	Bolt	M8x60-8.8 Zn
3	301 3224	2	Sechskantschraube DIN933	Screw	M10x30-8.8
4	301 7341	2	Sechskantschraube DIN931-A	Bolt	M12x65-8.8 Zn
5	301 7782	1	Bügelsschraube	U-bolt	M10x62x60
6	303 0932	4	Sicherungsmutter	Selflocking nut	DIN985-NM8-8 Zn
7	303 0933	4	Sicherungsmutter	Selflocking nut	DIN985-NM10-8 Zn
8	303 0934	2	Sicherungsmutter	Selflocking nut	DIN985-NM12-8 Zn
9	305 2050	6	Paßscheibe	Shim	30x42x1,0 DIN988
10	305 8580	2	Scheibe	Washer	13/24x2,5 St-Zn DIN125
11	305 8694	4	Scheibe	Washer	A8,4 DIN125-St Zn
12	305 8867	2	Sicherungsring	Securing ring	30x2 DIN471 Zn
13	313 3017	1	Bolzen mit Verdrehsicherung	Pin with stop	LN D30/31x62/84
14	313 3023	1	Bolzen mit Verdrehsicherung	Pin with stop	UN D30/72x62/84
15	323 6348	2	Schmiernippel	Grease nipple	AM10x1 DIN71412
16	325 1350	2	Spannband	Strap	6,3x254 VA
17	325 1502	2	EASY-READ Zeichen	EASY-READ sign	2
18	325 1511	1	EASY-READ Zeichen	EASY-READ sign	P
19	325 1512	1	EASY-READ Zeichen	EASY-READ sign	T
20	325 5128	1	Konsolenscheibe	Bracket clip	TYP 142 D137-145
21	375 2120	2	Staubkappe, grün	Cap	D26,5 Bg.3
22	375 2199	1	Kugelhahn	Valve	BKH 12L-M18x1,5 Zn
23	375 2205	1	Verbindung	Connection	DKOL12/IGM 16x1,5
24	375 2515	1	Drosselscheibe	Restrictor washer	Dreibein 2,5
25	375 2718	2	SVK-Stecker	SVK-socket	NW10-M18x1,5
26	375 4010	1	Einschraubverschraubung	Nipple	x-GE12-LM M16x1,5 Zn

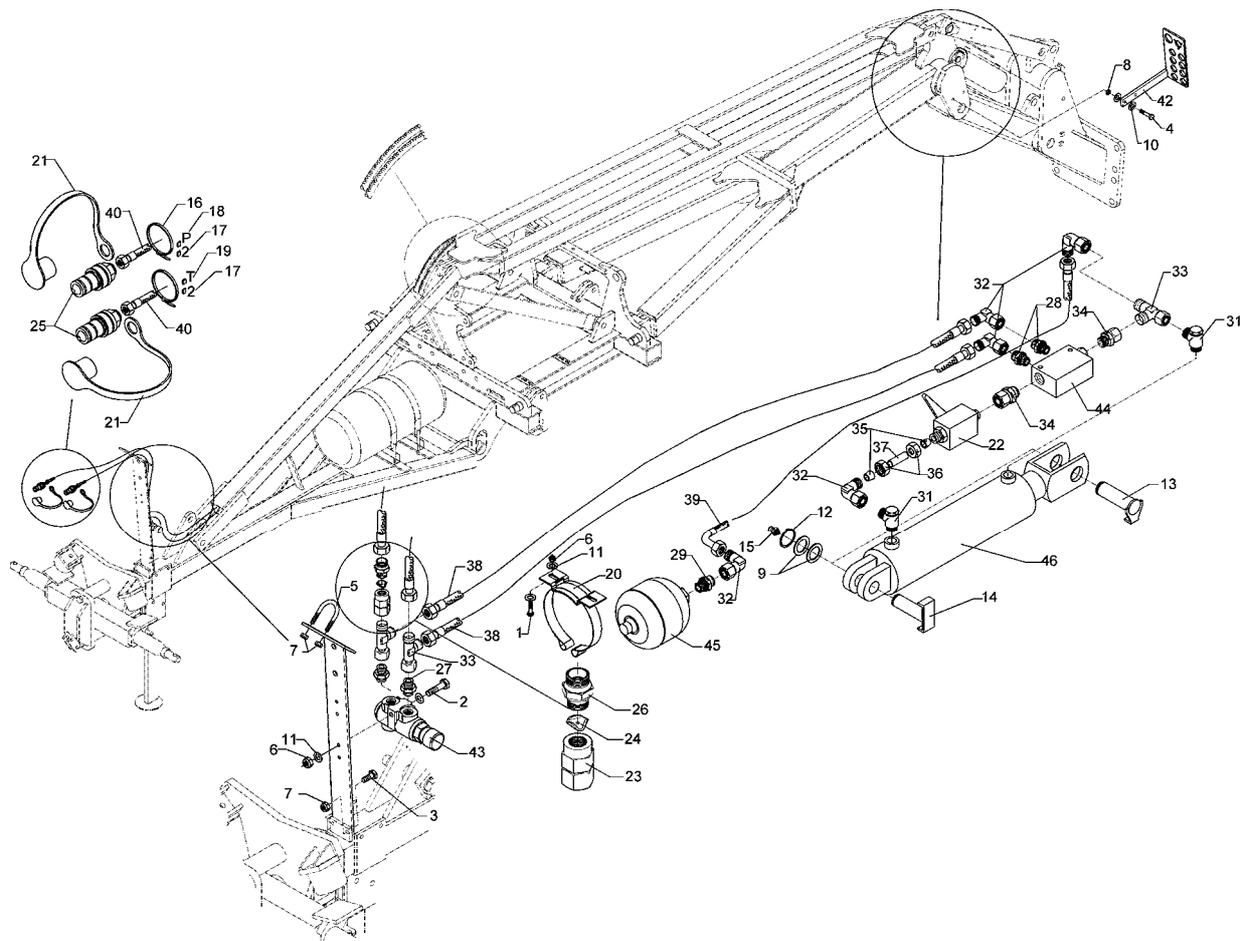

11.04

Pos.	Art.-Nr.	Stk.	Artikeltext / Description	Abmessung	
27	375 4020	2	Einschraubverschraubung	Nipple	x-GE12-LM M18x1,5 Zn
28	375 4038	2	Einschraubverschraubung	Nipple	GE 12-LR R1/4
29	375 4049	1	Einstellbare GE-Verschraubung	Nipple	evGE 12-LR 1/2-ED DKO24°
30	375 4210	1	Winkel-Verschraubung	Angle union	x-W12-L M18x1,5
31	375 4311	2	Schwenverschraubung	Union, swivel	x-SWVE12-LM M18x1,5 Zn
32	375 4500	4	Einstellbare W-Verschraubung	Adjustable angle union	x-evW12-LM DKO24° M18x1,5
33	375 4550	3	Einstellbare L-Verschraubung	L-adjustable T-union	x-evL12-L DKO24° M18x1,5
34	375 4711	2	Stutzen	Stud	x-evGE-12-ED 1/4 DKO 24°
35	375 5110	2	Schneidring	Cutting ring	12-L/S Zn WD
36	375 5310	2	Überwurfmutter	Union nut	12L M18x1,5 Zn
37	475 2219	1	Hydraulikrohr	Pipe	12x2x47
38	475 2506	2	Hydraulikschlauch	High-pressure hose	2SN08-6300-DKOL12
39	475 2597	1	Hydraulikschlauch	High-pressure hose	2SN10-700 DKOL12/DKOL12
40	475 2656	2	Hydraulikschlauch	High-pressure hose	1SN08-1800 M18x1,5 DKL
41	475 4361	1	Schlauchhalter	Hose carrier	80x8x700 4xD12
42	475 4362	1	Kupplungshalter	Coupling holder	210x295
43	575 2050	1	Druckbegrenzungsventil	Pressure limiting valve	5-80 bar M18x1,5 30l/min
44	575 2165	1	Rückschlagventil hy.entsperrb.	Nonreturn valve	RPI 06/05-G
45	575 2192	1	Druckspeicher	Pressure reservoir	Typ 1,4L-250 50bar 1/2
46	575 2359	1	Hydraulikzylinder mit Gabel	Ram	100/40-245-515-D30

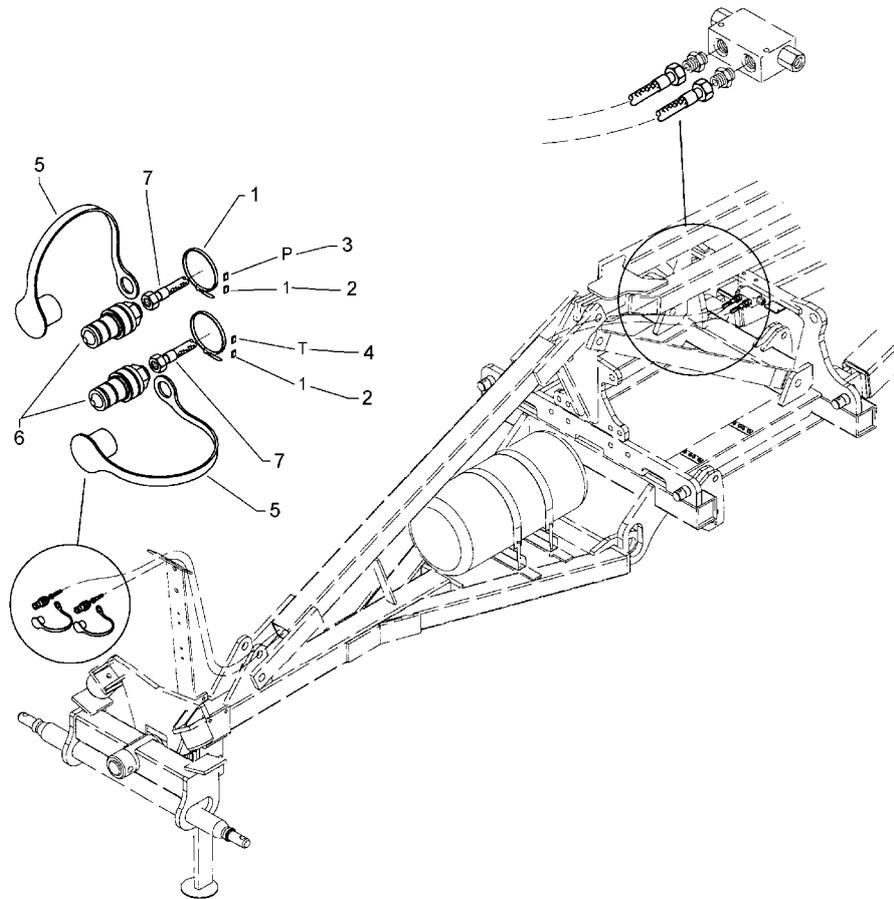

11.04

Pos.	Art.-Nr.	Stk.	Artikeltext / Description	Abmessung	
1	325 1350	2	Spannband	Strap	6,3x254 VA
2	325 1501	2	EASY-READ Zeichen	EASY-READ sign	1
3	325 1511	1	EASY-READ Zeichen	EASY-READ sign	P
4	325 1512	1	EASY-READ Zeichen	EASY-READ sign	T
5	375 2166	2	Staubkappe, rot	Cap, red	D26,5
6	375 2718	2	SVK-Stecker	SVK-socket	NW10-M18x1,5
7	475 2501	2	Hydraulikschlauch	High-pressure hose	2SN08-5000-DKOL12

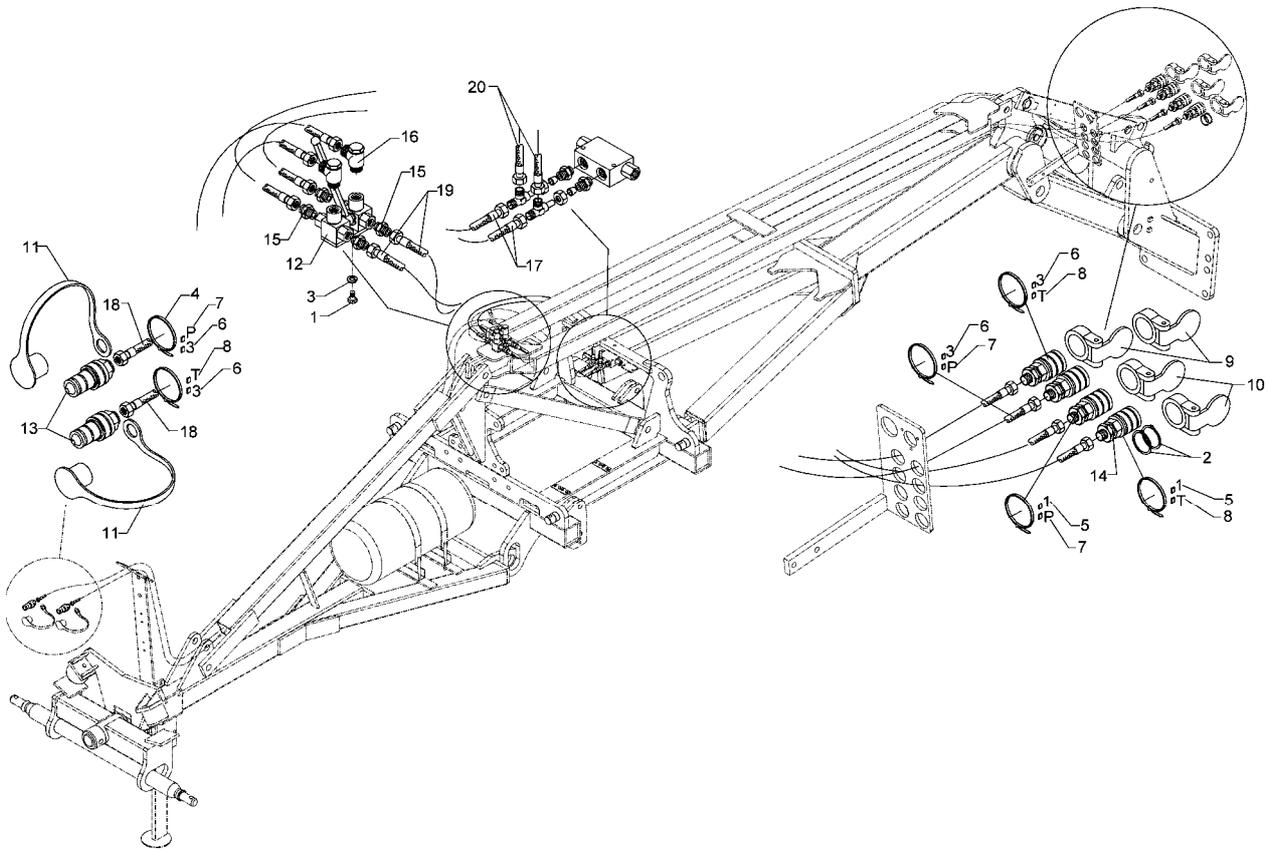

11.04

Pos.	Art.-Nr.	Stk.	Artikeltext / Description	Abmessung	
1	301 7280	1	Sechskantschraube DIN933	Screw	M8x25-8.8 Zn
2	305 8871	8	Sicherungsring	Securing ring	38x1,75 DIN471 Zn
3	305 9898	1	Federring	Spring ring	8 A DIN127 Zn
4	325 1350	6	Spannband	Strap	6,3x254 VA
5	325 1501	4	EASY-READ Zeichen	EASY-READ sign	1
6	325 1503	2	EASY-READ Zeichen	EASY-READ sign	3
7	325 1511	3	EASY-READ Zeichen	EASY-READ sign	P
8	325 1512	3	EASY-READ Zeichen	EASY-READ sign	T
9	375 2101	2	Staubschutzklappe blau	Dust protection flap	BG 3 D38
10	375 2105	2	Staubschutzklappe rot	Dust protection flap	BG 3 D38
11	375 2166	2	Staubkappe, rot	Cap, red	D26,5
12	375 2200	1	Wegeventil	Valve	6/2-L M16x1,5
13	375 2718	2	SVK-Stecker	SVK-socket	NW10-M18x1,5
14	375 2735	4	SVK-Muffe	SVK-socket	CEL12 M18x1,5 BG3
15	375 4010	4	Einschraubverschraubung	Nipple	x-GE12-LM M16x1,5 Zn
16	375 4310	2	Schwenkverschraubung	Union, swivel	x-SWVE12-LM M16x1,5
17	475 2500	2	Hydraulikschlauch	High-pressure hose	2SN08-4400-DKOL12
18	475 2501	2	Hydraulikschlauch	High-pressure hose	2SN08-5000-DKOL12
19	475 2642	2	Hydraulikschlauch	High-pressure hose	1SN08-3900 DKOL-12L
20	475 2654	2	Hydraulikschlauch	High-pressure hose	2SN08-800 DKOL12

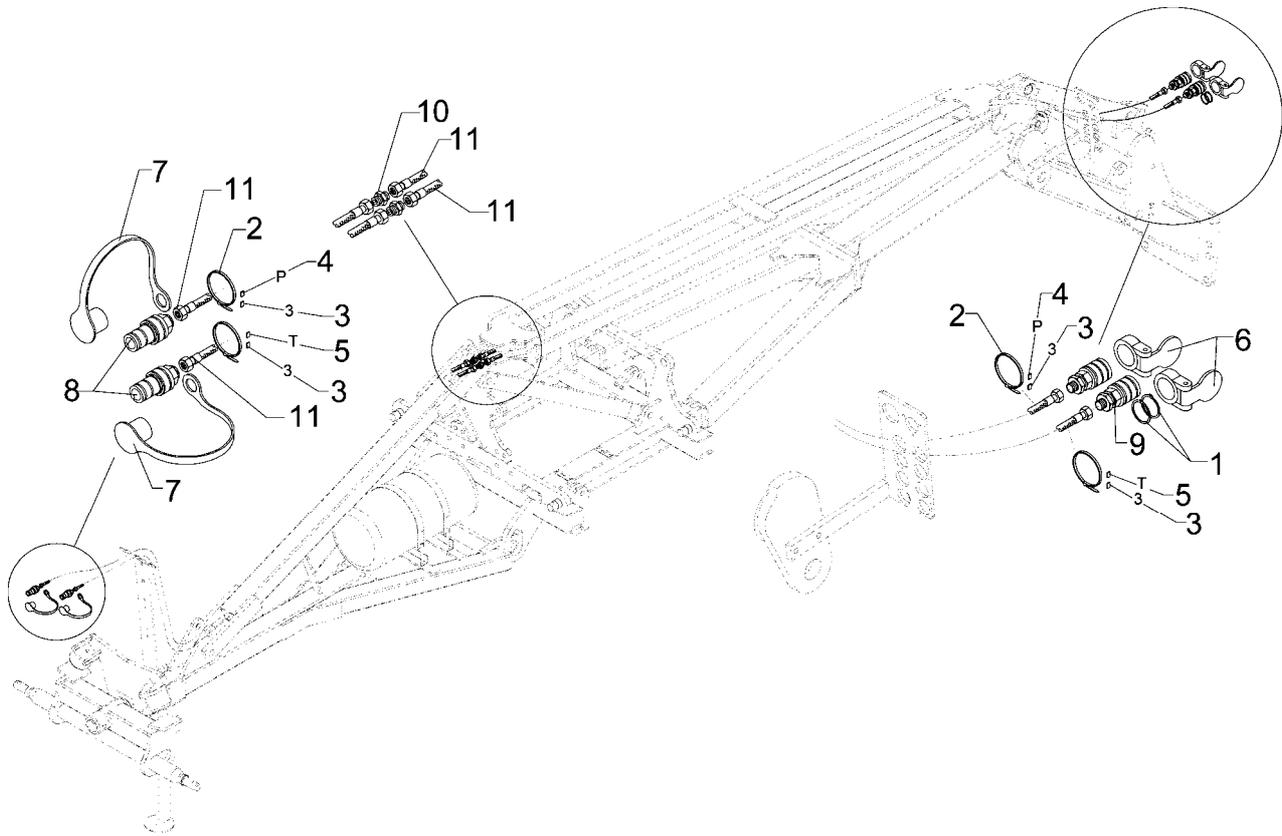

11.04

Pos.	Art.-Nr.	Stk.	Artikeltext / Description		Abmessung
1	305 8871	4	Sicherungsring	Securing ring	38x1,75 DIN471 Zn
2	325 1350	4	Spannband	Strap	6,3x254 VA
3	325 1503	4	EASY-READ Zeichen	EASY-READ sign	3
4	325 1511	2	EASY-READ Zeichen	EASY-READ sign	P
5	325 1512	2	EASY-READ Zeichen	EASY-READ sign	T
6	375 2101	2	Staubschutzklappe blau	Dust protection flap	BG 3 D38
7	375 2121	2	Staubkappe, blau	Cap	D26,5 Bg.3
8	375 2718	2	SVK-Stecker	SVK-socket	NW10-M18x1,5
9	375 2735	2	SVK-Muffe	SVK-socket	CEL12 M18x1,5 BG3
10	375 4110	2	Gerade Verschraubung	Nipple	x-G12-L M18x1,5
11	475 2624	4	Hydraulikschlauch	High-pressure hose	2SN10-4100 M18x1,5

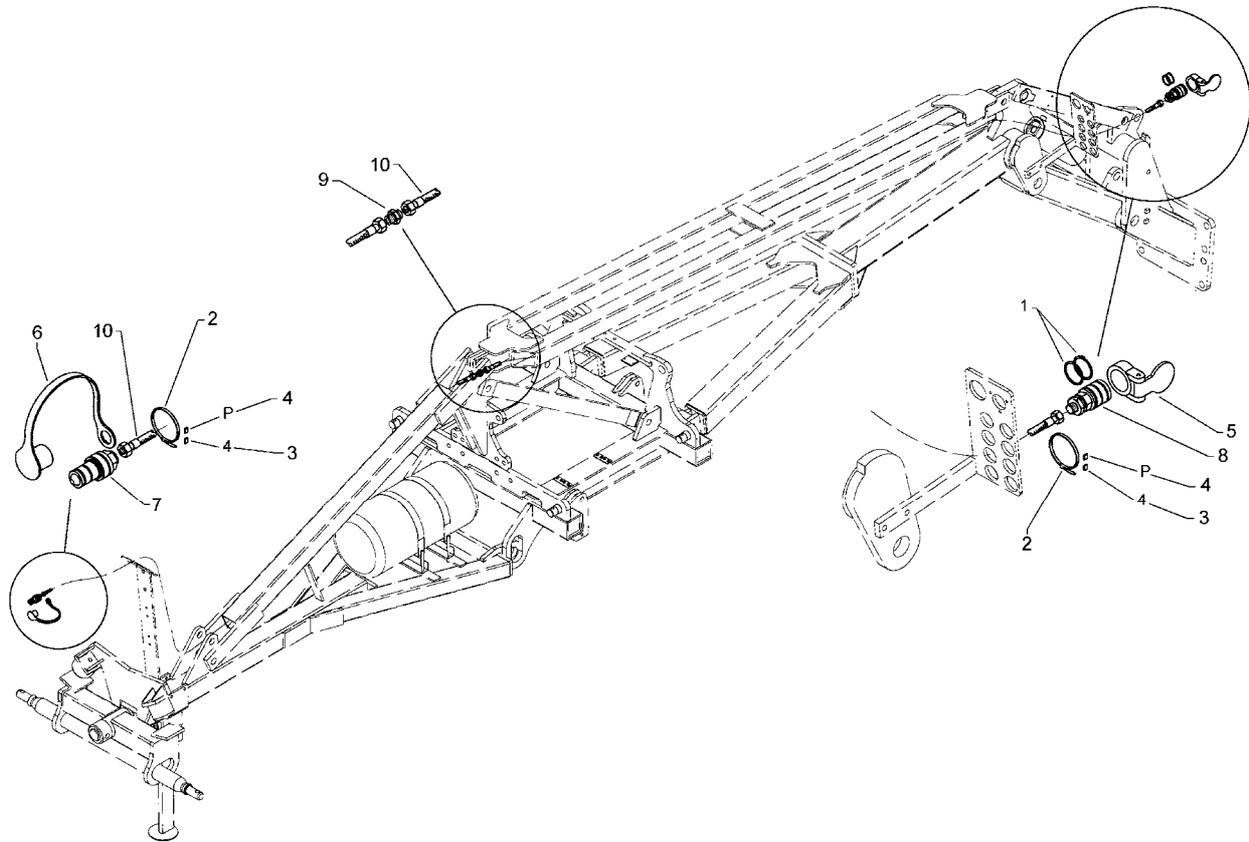

11.04

Pos.	Art.-Nr.	Stk.	Artikeltext / Description		Abmessung
1	305 8871	2	Sicherungsring	Securing ring	38x1,75 DIN471 Zn
2	325 1350	2	Spannband	Strap	6,3x254 VA
3	325 1504	2	EASY-READ Zeichen	EASY-READ sign	4
4	325 1511	2	EASY-READ Zeichen	EASY-READ sign	P
5	375 2102	1	Staubschutzklappe schwarz	Dust protection flap	BG 3 D38
6	375 2122	1	Staubkappe, schwarz	Cap, black	D26,5 Bg.3
7	375 2718	1	SVK-Stecker	SVK-socket	NW10-M18x1,5
8	375 2735	1	SVK-Muffe	SVK-socket	CEL12 M18x1,5 BG3
9	375 4110	1	Gerade Verschraubung	Nipple	x-G12-L M18x1,5
10	475 2624	2	Hydraulikschlauch	High-pressure hose	2SN10-4100 M18x1,5

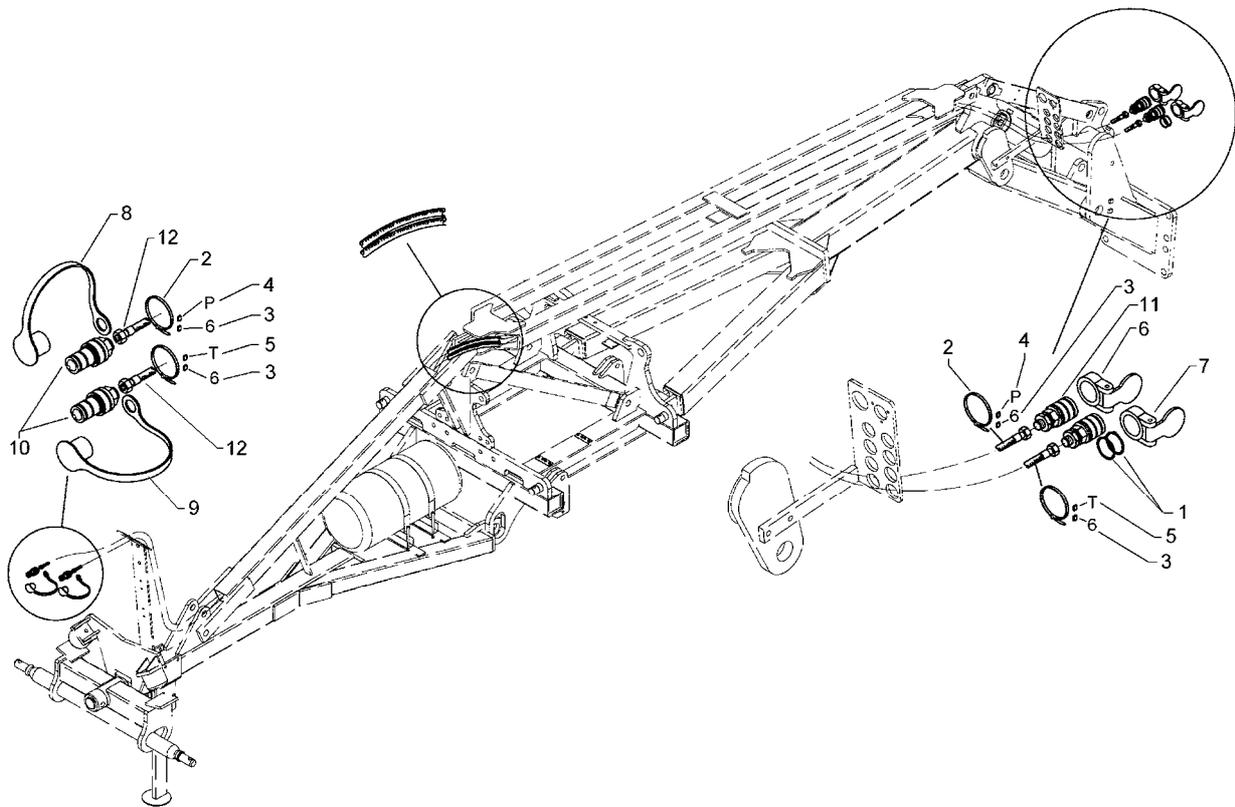

11.04

Pos.	Art.-Nr.	Stk.	Artikeltext / Description		Abmessung
1	305 8875	4	Sicherungsring	Securing ring	40x2,5 DIN471
2	325 1350	4	Spannband	Strap	6,3x254 VA
3	325 1506	4	EASY-READ Zeichen	EASY-READ sign	6
4	325 1511	2	EASY-READ Zeichen	EASY-READ sign	P
5	325 1512	2	EASY-READ Zeichen	EASY-READ sign	T
6	375 2103	1	Staubschutzklappe gelb	Dust protection flap	BG 3 D38
7	375 2104	1	Staubschutzklappe weiss	Dust protection flap	BG 3 D38
8	375 2123	1	Staubkappe, gelb	Cap	D26,5 Bg.3
9	375 2124	1	Staubkappe, weiss	Cap, white	D26,5 Bg.3
10	375 2736	2	SVK-Muffe	SVK-socket	BG-3 15L CEL M22x1,5 SW-27
11	375 2737	2	SVK-Muffe	SVK-socket	BG-3 CEL15 M22x1,5
12	475 2669	2	Hydraulikschlauch	High-pressure hose	2SN12-7900 M22x1,5

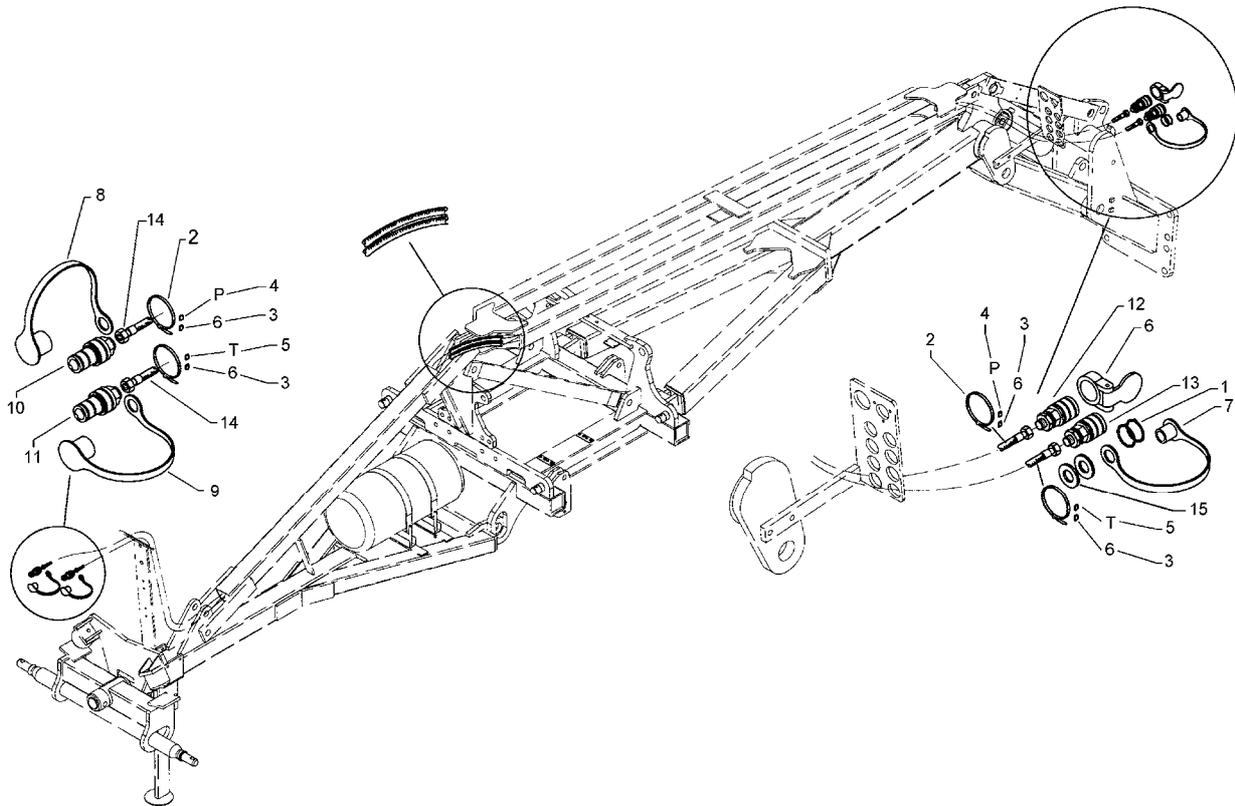

11.04

Pos.	Art.-Nr.	Stk.	Artikeltext / Description		Abmessung
1	305 8875	2	Sicherungsring	Securing ring	40x2,5 DIN471
2	325 1350	4	Spannband	Strap	6,3x254 VA
3	325 1506	4	EASY-READ Zeichen	EASY-READ sign	6
4	325 1511	2	EASY-READ Zeichen	EASY-READ sign	P
5	325 1512	2	EASY-READ Zeichen	EASY-READ sign	T
6	375 2103	1	Staubschutzklappe gelb	Dust protection flap	BG 3 D38
7	375 2162	1	Staubstecker	Plastic male probe	BG 6
8	375 2123	1	Staubkappe, gelb	Cap	D26,5 Bg.3
9	375 2168	1	Schutzkappe	Cap	BG.6 rot
10	375 2736	1	SVK-Muffe	SVK-socket	BG-3 15L CEL M22x1,5 SW-27
11	375 2720	1	SVK-Stecker	SVK-socket	SVK-BG 6 M22x1,5
12	375 2737	1	SVK-Muffe	SVK-socket	BG-3 CEL15 M22x1,5
13	375 2738	1	SVK-Muffe	SVK-socket	BG6 M22x1,5
14	475 2669	2	Hydraulikschlauch	High-pressure hose	2SN12-7900 M22x1,5
15	305 6982	2	Scheibe	Washer	R22/68x5 DIN440-St Zn

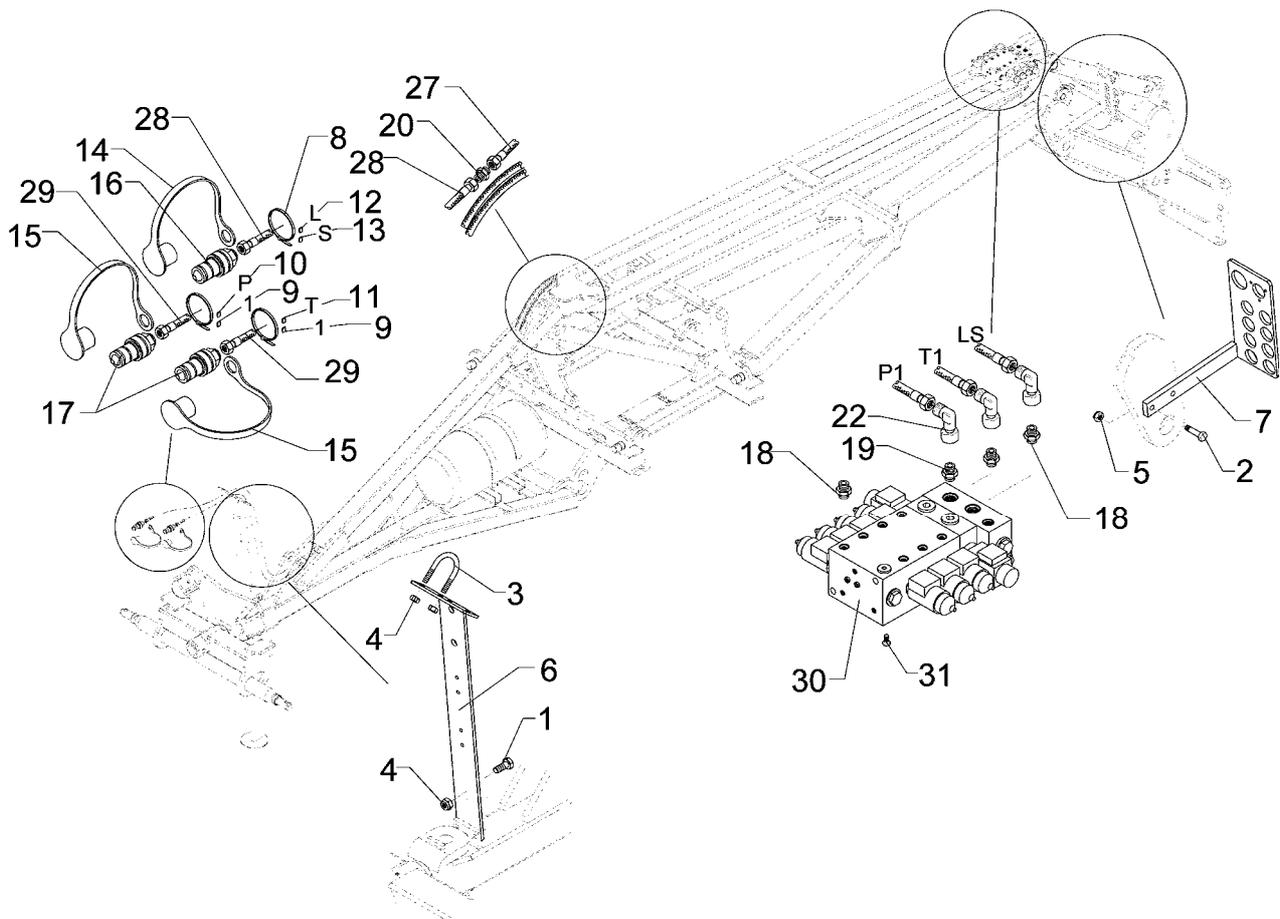

11.04

Pos.	Art.-Nr.	Stk.	Artikeltext / Description	Abmessung	
1	301 3224	2	Sechskantschraube DIN933	Screw	M10x30-8.8
2	301 3397	2	Sechskantschraube DIN931-A	Bolt	M12x65-8.8
3	301 7782	1	Bügelschraube	U-bolt	M10x62x60
4	303 0933	4	Sicherungsmutter	Selflocking nut	DIN985-NM10-8 Zn
5	303 0934	2	Sicherungsmutter	Selflocking nut	DIN985-NM12-8 Zn
6	475 4361	1	Schlauchhalter	Hose carrier	80x8x700 4xD12
7	475 4362	1	Kupplungshalter	Coupling holder	210x295
8	325 1350	3	Spannband	Strap	6,3x254 VA
9	325 1501	2	EASY-READ Zeichen	EASY-READ sign	1
10	325 1511	1	EASY-READ Zeichen	EASY-READ sign	P
11	325 1512	1	EASY-READ Zeichen	EASY-READ sign	T
12	325 1513	1	EASY-READ Zeichen	EASY-READ sign	L
13	325 1514	1	EASY-READ Zeichen	EASY-READ sign	S
14	375 2164	1	Schutzkappe rot	Cap	Bg.2
15	375 2166	2	Staubkappe, rot	Cap, red	D26,5
16	375 2716	1	SVK-Stecker	SVK-socket	NW8 M16x1,5
17	375 2736	2	SVK-Muffe	SVK-socket	BG-3 15L CEL M22x1,5 SW-27
18	375 4009	8	Einschraubverschraubung	Nipple	x-GE12-LM M14x1,5 Zn
19	375 4032	2	Gerade Einschraubverschraubung	Nipple	x-GE15-LM 22x1,5-ED
20	375 4110	1	Gerade Verschraubung	Nipple	x-G12-L M18x1,5
22	375 4503	4	Einstellbare W-Verschraubung	Adjustable angle union	x-evW15-L-DKO24° O-Ring
27	475 2676	1	Hydraulikschlauch	High-pressure hose	NW8x4800 M16/M18x1,5
28	475 2657	1	Hydraulikschlauch	High-pressure hose	1SN08-3000 DKOL12/DKOL12
29	475 2669	2	Hydraulikschlauch	High-pressure hose	2SN12-7900 M22x1,5
30	575 2193	1	Steuerblock	Control valve	L8S-3D/1E
31	301 7280	3	Sechskantschraube DIN933	Screw	M8x25-8.8 Zn

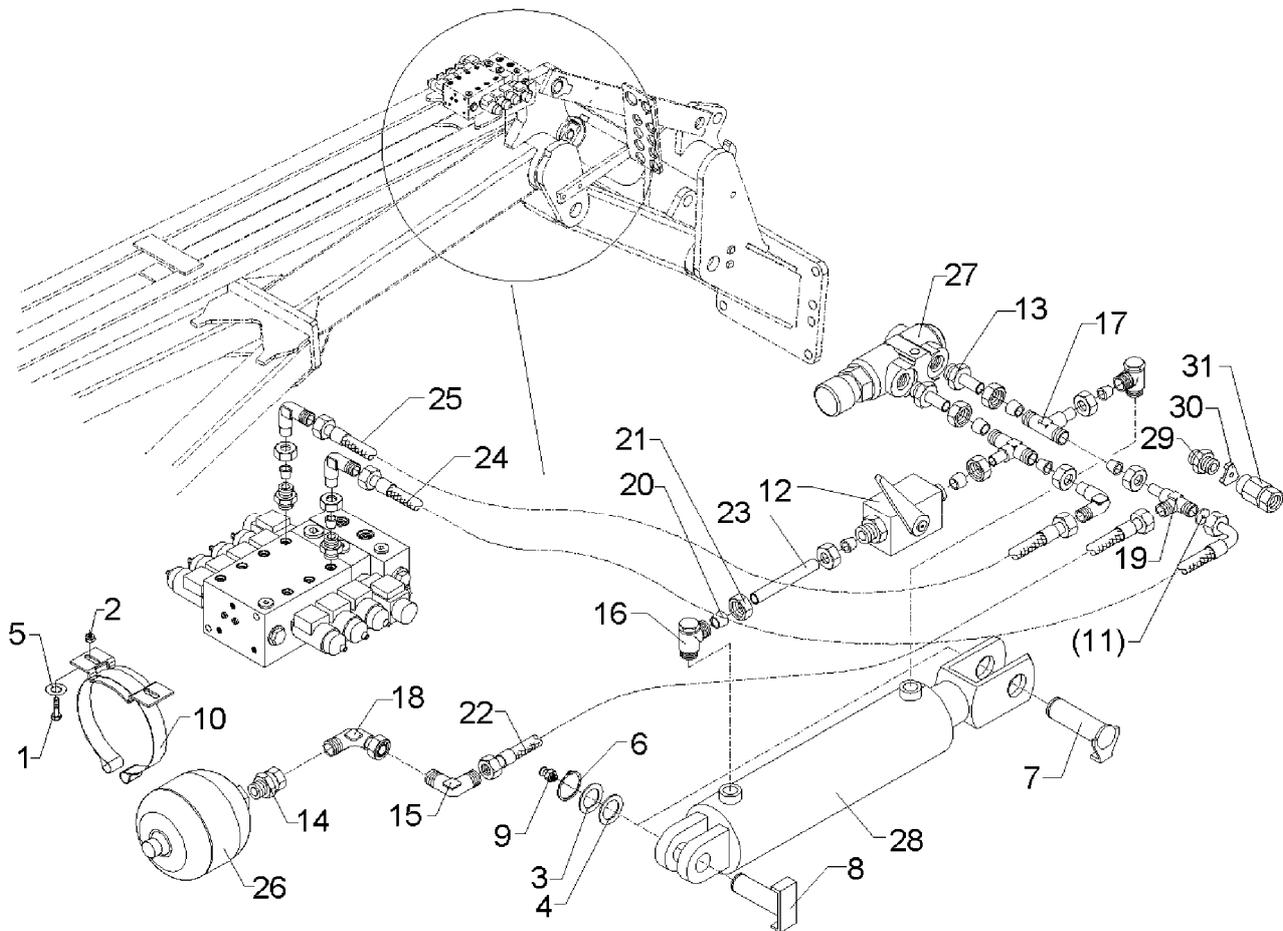

11.04

Pos.	Art.-Nr.	Stk.	Artikeltext / Description	Abmessung	
1	301 3073	2	Sechskantschraube DIN931-A	Bolt	M8x45-8.8 Zn
2	303 0932	2	Sicherungsmutter	Selflocking nut	DIN985-NM8-8 Zn
3	305 2050	6	Paßscheibe	Shim	30x42x1,0 DIN988
5	305 8694	4	Scheibe	Washer	A8,4 DIN125-St Zn
6	305 8867	2	Sicherungsring	Securing ring	30x2 DIN471 Zn
7	313 3017	1	Bolzen mit Verdrehsicherung	Pin with stop	LN D30/31x62/84
8	313 3023	1	Bolzen mit Verdrehsicherung	Pin with stop	UN D30/72x62/84
9	323 6348	2	Schmiernippel	Grease nipple	AM10x1 DIN71412
10	325 5128	1	Konsolenschelle	Bracket clip	TYP 142 D137-145
11	375 2176	1	Drosselplättchen	Throttle plate	D12x1,5 BO 2,5
12	375 2199	1	Kugelhahn	Valve	BKH 12L-M18x1,5 Zn
13	375 4711	4	Stutzen	Stud	x-evGE-12-ED 1/4 DKO 24°
14	375 4039	1	Einschraubverschraubung	Nipple	GE 12-LR R1/2
16	375 4311	2	Schwenkverschraubung	Union, swivel	x-SWVE12-LM M18x1,5 Zn
17	375 4490	2	Einstellbare T-Verschraubung	T-adjustable T-union	x-evT12-LM DKO24° M18x1,5
18	375 4500	4	Einstellbare W-Verschraubung	Adjustable angle union	x-evW12-LM DKO24° M18x1,5
19	375 4550	1	Einstellbare L-Verschraubung	L-adjustable T-union	x-evL12-L DKO24° M18x1,5
20	375 5110	2	Schneidring	Cutting ring	12-L/S Zn WD
21	375 5310	2	Überwurfmutter	Union nut	12L M18x1,5 Zn
22	475 2696	1	Hydraulikschlauch	High-pressure hose	2SN08-1000-DKOL12/DKOL12-90°
23	475 2223	1	Rohr	Tube	12x2x85
24	475 2597	1	Hydraulikschlauch	High-pressure hose	2SN10-700 DKOL12/DKOL12
25	475 2615	1	Hydraulikschlauch	High-pressure hose	2SN10-1200 M18x1,5
26	575 2192	1	Druckspeicher	Pressure reservoir	Typ 1,4L-250 50bar 1/2
27	575 2050	1	Druckbegrenzungsventil	Pressure limiting valve	5-80 bar M18x1,5 30l/min

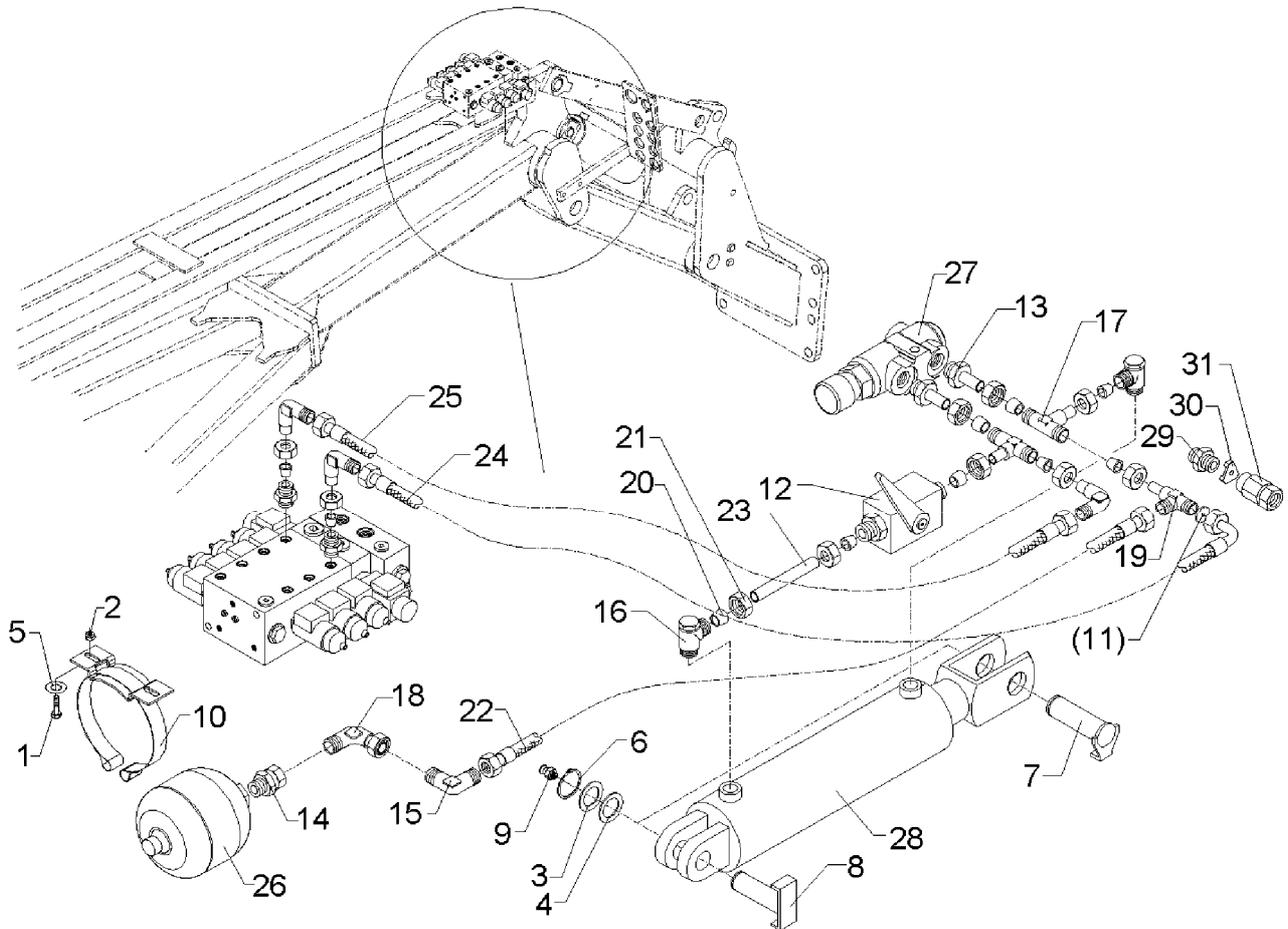

11.04

Pos.	Art.-Nr.	Stk.	Artikeltext / Description	Abmessung
28	575 2359	1	Hydraulikzylinder mit Gabel	Ram
29	375 4010	1	Einschraubverschraubung	Nipple
30	375 2515	1	Drosselscheibe	Restrictor washer
31	375 2205	1	Verbindung	Connection
				100/40-245-515-D30
				x-GE12-LM M16x1,5 Zn
				Dreibein 2,5
				DKOL12/IGM 16x1,5

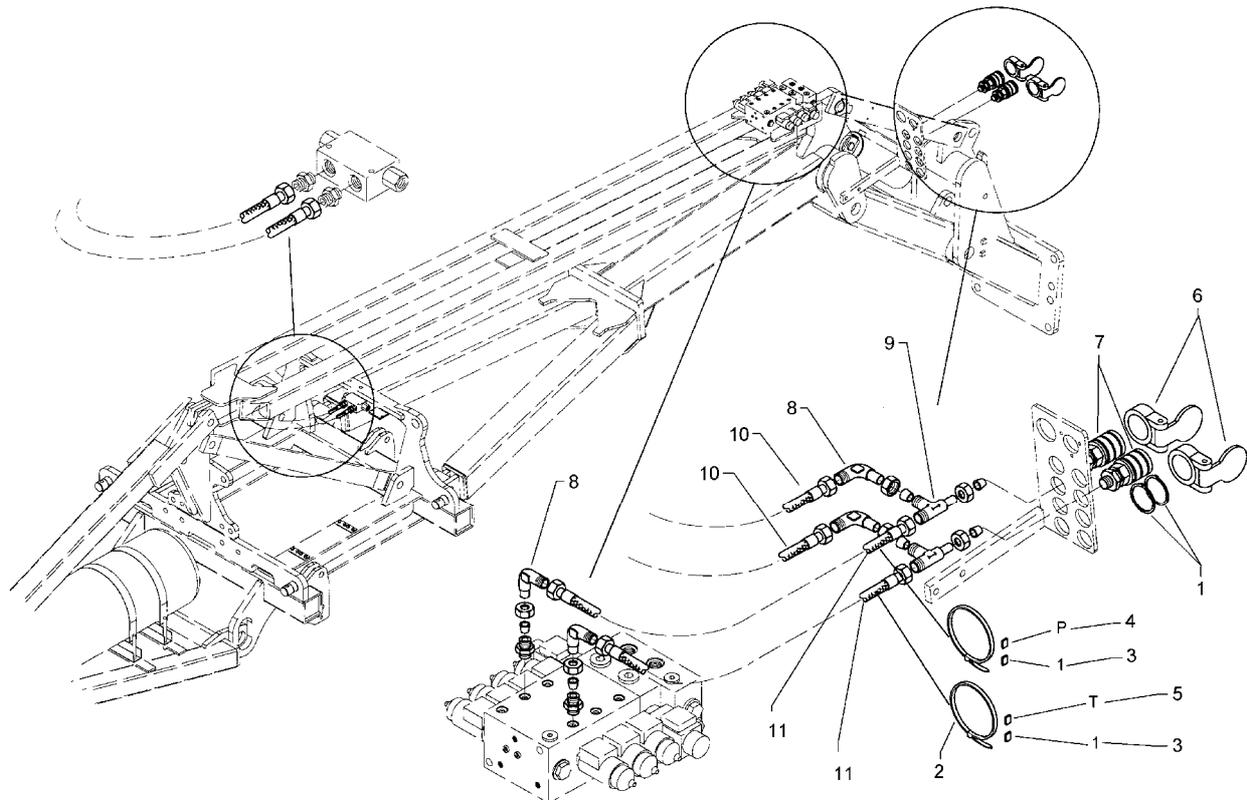

11.04

Pos.	Art.-Nr.	Stk.	Artikeltext / Description		Abmessung
1	305 8871	4	Sicherungsring	Securing ring	38x1,75 DIN471 Zn
2	325 1350	2	Spannband	Strap	6,3x254 VA
3	325 1501	2	EASY-READ Zeichen	EASY-READ sign	1
4	325 1511	1	EASY-READ Zeichen	EASY-READ sign	P
5	325 1512	1	EASY-READ Zeichen	EASY-READ sign	T
6	375 2105	2	Staubschutzklappe rot	Dust protection flap	BG 3 D38
7	375 2735	2	SVK-Muffe	SVK-socket	CEL12 M18x1,5 BG3
8	375 4500	4	Einstellbare W-Verschraubung	Adjustable angle union	x-evW12-LM DKO24° M18x1,5
9	375 4550	2	Einstellbare L-Verschraubung	L-adjustable T-union	x-evL12-L DKO24° M18x1,5
10	475 2500	2	Hydraulikschlauch	High-pressure hose	2SN08-4400-DKOL12
11	475 2696	2	Hydraulikschlauch	High-pressure hose	2SN08-1000-DKOL12/DKOL12-90°

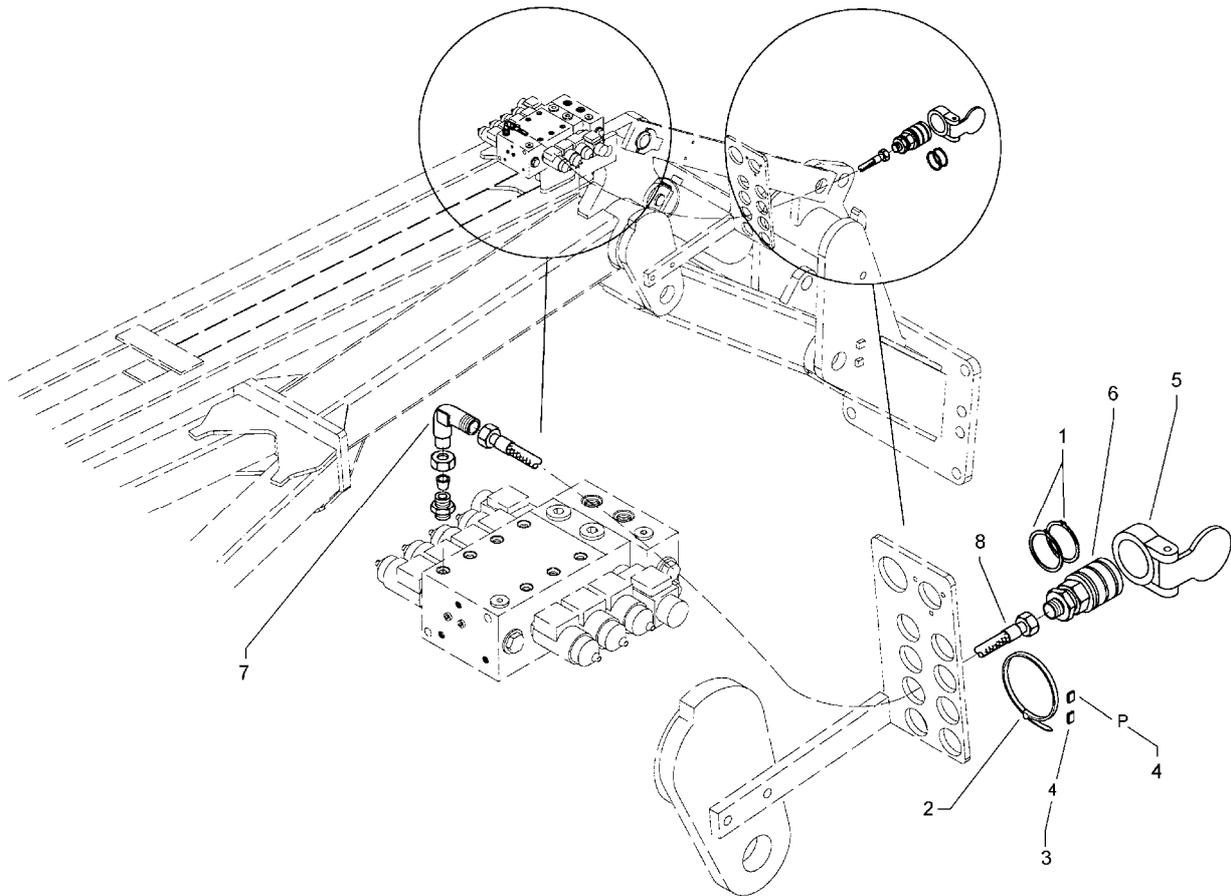

11.04

Pos.	Art.-Nr.	Stk.	Artikeltext / Description	Abmessung	
1	305 8871	2	Sicherungsring	Securing ring	38x1,75 DIN471 Zn
2	325 1350	1	Spannband	Strap	6,3x254 VA
3	325 1504	1	EASY-READ Zeichen	EASY-READ sign	4
4	325 1511	1	EASY-READ Zeichen	EASY-READ sign	P
5	375 2102	1	Staubschutzklappe schwarz	Dust protection flap	BG 3 D38
6	375 2735	1	SVK-Muffe	SVK-socket	CEL12 M18x1,5 BG3
7	375 4500	1	Einstellbare W-Verschraubung	Adjustable angle union	x-evW12-LM DKO24° M18x1,5
8	475 2696	1	Hydraulikschlauch	High-pressure hose	2SN08-1000-DKOL12/DKOL12-90

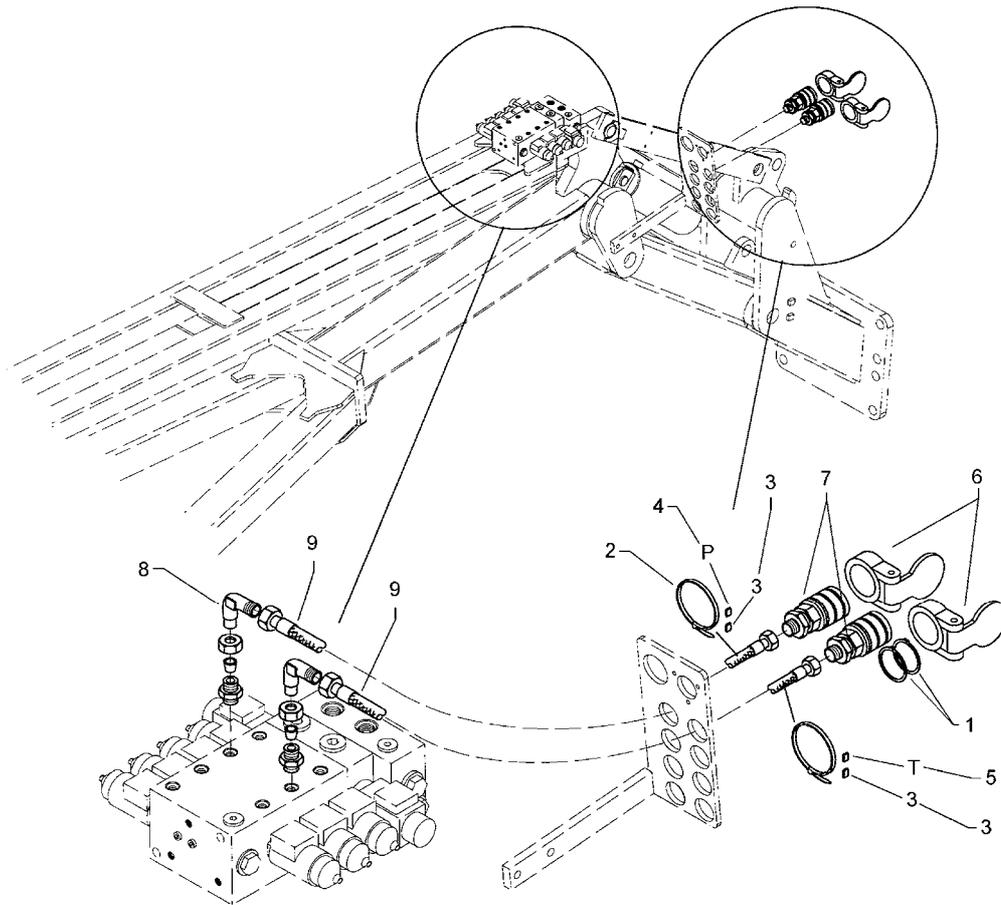

11.04

Pos.	Art.-Nr.	Stk.	Artikeltext / Description		Abmessung
1	305 8871	4	Sicherungsring	Securing ring	38x1,75 DIN471 Zn
2	325 1350	2	Spannband	Strap	6,3x254 VA
3	325 1503	2	EASY-READ Zeichen	EASY-READ sign	3
4	325 1511	1	EASY-READ Zeichen	EASY-READ sign	P
5	325 1512	1	EASY-READ Zeichen	EASY-READ sign	T
6	375 2101	2	Staubschutzklappe blau	Dust protection flap	BG 3 D38
7	375 2735	2	SVK-Muffe	SVK-socket	CEL12 M18x1,5 BG3
8	375 4500	2	Einstellbare W-Verschraubung	Adjustable angle union	x-evW12-LM DKO24° M18x1,5
9	475 2655	2	Hydraulikschlauch	High-pressure hose	1SN08-900 M18x1,5

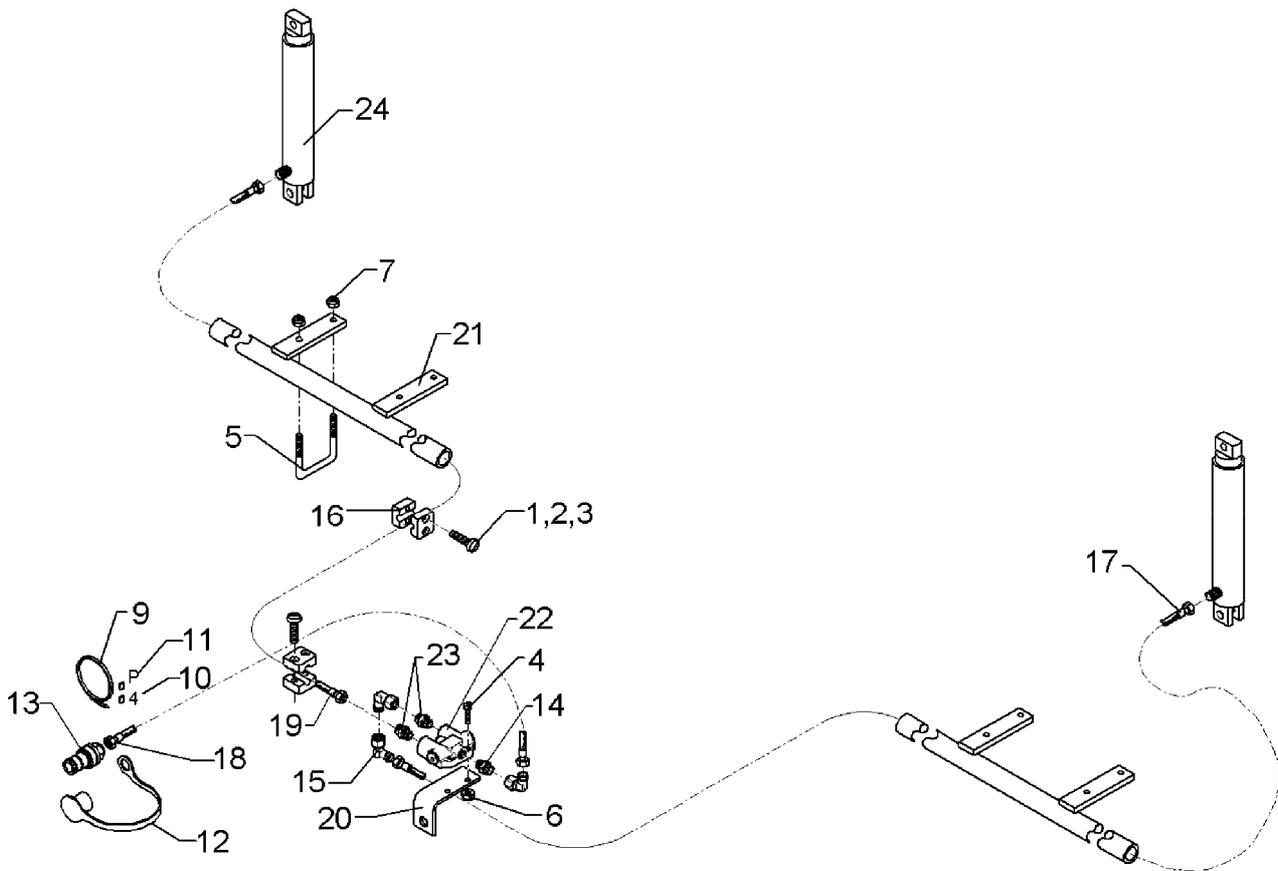

11.04

Pos.	Art.-Nr.	Stk.	Artikeltext / Description		Abmessung
1	301 0303	2	Flachkopfschraube DIN85	Flatheaded bolt	M6x30-4,6 Zn
2	301 0308	8	Flachkopfschraube DIN85	Flatheaded bolt	M6x55-4,6 Zn
3	301 0312	4	Flachkopfschraube DIN85	Flatheaded bolt	M6x75-4,6 Zn
4	301 3073	2	Sechskantschraube DIN931-A	Bolt	M8x45-8.8 Zn
5	301 7785	4	Bügelsschraube	U-bolt	M10x80x110
6	303 0932	2	Sicherungsmutter	Selflocking nut	DIN985-NM8-8 Zn
7	303 0933	8	Sicherungsmutter	Selflocking nut	DIN985-NM10-8 Zn
8	305 6124	2	Scheibe	Washer	8,4/25x2 DIN9021-St Zn
9	325 1350	1	Spannband	Strap	6,3x254 VA
10	325 1504	1	EASY-READ Zeichen	EASY-READ sign	4
11	325 1511	1	EASY-READ Zeichen	EASY-READ sign	P
12	375 2122	1	Staubkappe, schwarz	Cap, black	D26,5 Bg.3
13	375 2718	1	SVK-Stecker	SVK-socket	NW10-M18x1,5
14	375 4020	1	Einschraubverschraubung	Nipple	x-GE12-LM M18x1,5 Zn
15	375 4500	3	Einstellbare W-Verschraubung	Adjustable angle union	x-evW12-LM DKO24° M18x1,5
16	375 9964	16	Schellenkörper	Clamp	1/2x319PP
17	475 2413	1	Hydraulikschlauch	High-pressure hose	NW10 M18x4800
18	475 2414	1	Hydraulikschlauch	High-pressure hose	2SN10 M18x1,5x5600
19	475 2501	1	Hydraulikschlauch	High-pressure hose	2SN08-5000-DKOL12
20	475 4355	1	Halter für Umschaltblock	Holder	50x6x190 D20 3xD10
21	475 4366	2	Schlauchhalter	Hose carrier	D42,5x6,3x1740
22	575 2141	1	Ventil m.Drossel Spuranreißer	Valve	M18x1,5
23	575 2186	2	Drosselrückschlagventil	Throttle nonreturn valve	7Liter SW24 M18x1,5
24	575 2312	2	Plunger-Zylinder	Plunger-ram	40-210-378 2xD20,25

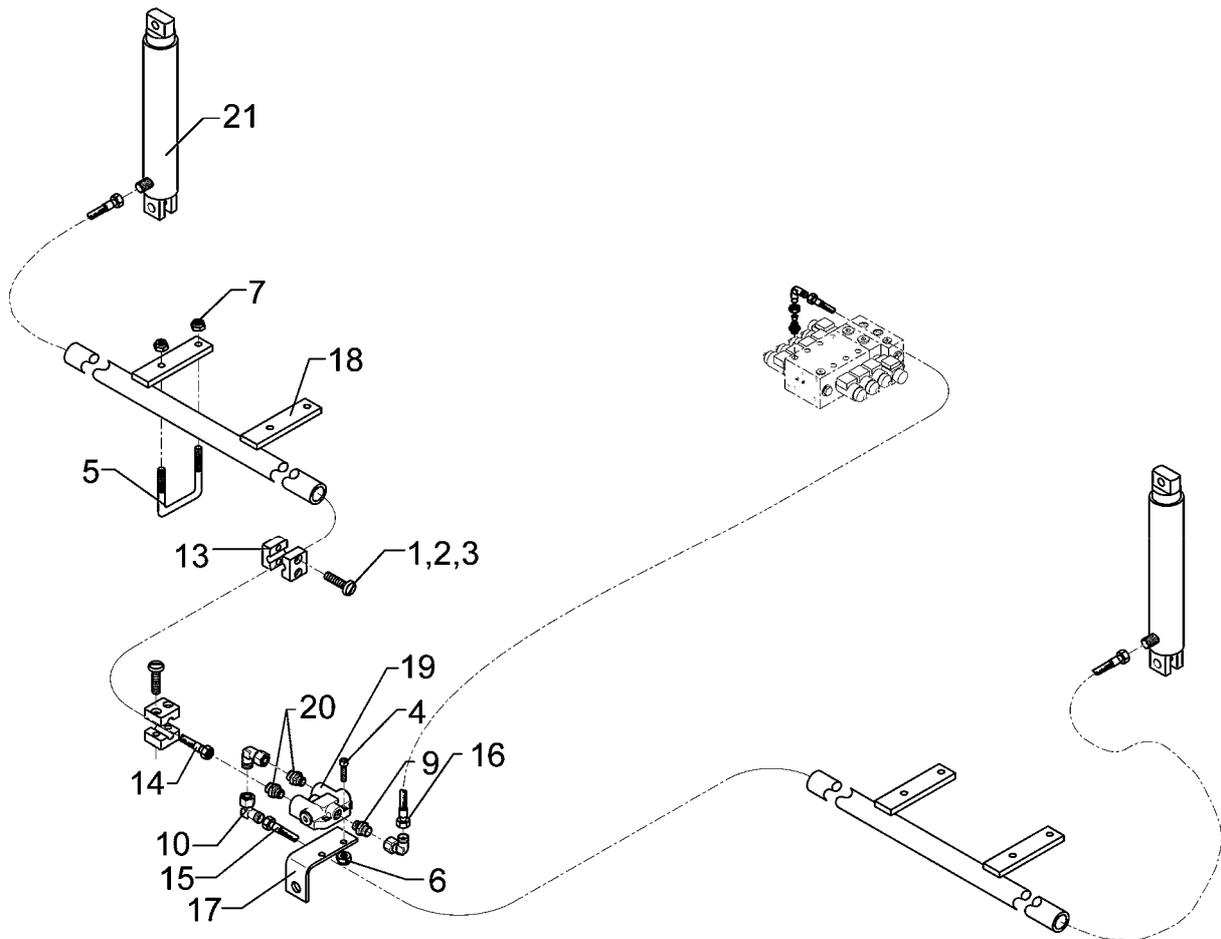

11.04

Pos.	Art.-Nr.	Stk.	Artikeltext / Description		Abmessung
1	301 0306	2	Flachkopfschraube DIN85	Flatheaded bolt	M6x45-4,6 Zn
2	301 0308	4	Flachkopfschraube DIN85	Flatheaded bolt	M6x55-4,6 Zn
3	301 0312	4	Flachkopfschraube DIN85	Flatheaded bolt	M6x75-4,6 Zn
4	301 6068	2	Zylinderschraube DIN912	Allen screw	M8x30-8.8 Zn
5	301 7785	4	Bügelsschraube	U-bolt	M10x80x110
6	303 0932	2	Sicherungsmutter	Selflocking nut	DIN985-NM8-8 Zn
7	303 0933	8	Sicherungsmutter	Selflocking nut	DIN985-NM10-8 Zn
9	375 4020	1	Einschraubverschraubung	Nipple	x-GE12-LM M18x1,5 Zn
10	375 4500	8	Einstellbare W-Verschraubung	Adjustable angle union	x-evW12-LM DKO24° M18x1,5
13	375 9964	13	Schellenkörper	Clamp	1/2x319PP
14	475 2413	1	Hydraulikschlauch	High-pressure hose	NW10 M18x4800
15	475 2414	1	Hydraulikschlauch	High-pressure hose	2SN10 M18x1,5x5600
16	475 2624	1	Hydraulikschlauch	High-pressure hose	2SN10-4100 M18x1,5
17	475 4355	1	Halter für Umschaltblock	Holder	50x6x190 D20 3xD10
18	475 4366	2	Schlauchhalter	Hose carrier	D42,5x6,3x1740
19	575 2141	1	Ventil m.Drossel Spuranreißer	Valve	M18x1,5
20	575 2186	2	Drosselrückschlagventil	Throttle nonreturn valve	7Liter SW24 M18x1,5
21	575 2312	2	Plunger-Zylinder	Plunger-ram	40-210-378 2xD20,25

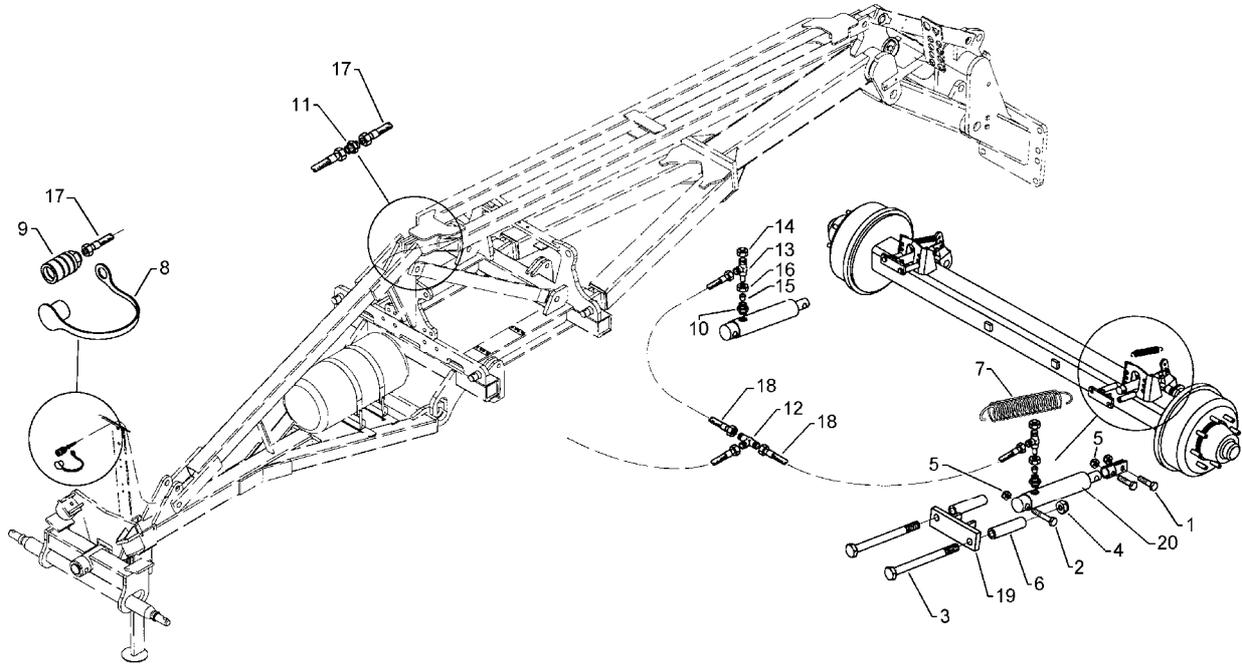

11.04

Pos.	Art.-Nr.	Stk.	Artikeltext / Description	Abmessung	
1	301 3575	2	Sechskantschraube DIN933	Screw	M14x40 8.8
2	301 3596	2	Sechskantschraube spz.	Bolt	M14x75-8.8
3	301 5410	4	Sechskantschraube DIN931-A	Bolt	M16x160-8.8 Zn
4	303 0935	4	Sicherungsmutter	Selflocking nut	DIN985-NM16-8 Zn
5	303 0941	4	Sicherungsmutter	Selflocking nut	DIN985-NM14-8 Zn
6	317 6802	4	Röhrchen	Tube	26,9x5x110
7	329 8511	2	Zugfeder	Spring	4x28x160
8	375 2161	1	SVBK-Staubstecker rot m.Kette	SVBK-male probe red with chain	BG 3
9	375 2739	1	SBVK-Muffe BG3 M18x1,5	Socket	Knappmann Nr.2601-1003
10	375 4044	2	Gerade Einschraubver.+Weichdi.	Nipple	x-GE12-LR 3/8
11	375 4110	1	Gerade Verschraubung	Nipple	x-G12-L M18x1,5
12	375 4480	1	T-Verschraubung	T-union	x-T12-L M18x1,5 Zn
13	375 4550	2	Einstellbare L-Verschraubung	L-adjustable T-union	x-evL12-L DKO24° M18x1,5
14	375 4660	2	Blindbutzen	Blind plug	BUZ12-L
15	375 5110	2	Schneidring	Cutting ring	12-L/S Zn WD
16	375 5310	4	Überwurfmutter	Union nut	12L M18x1,5 Zn
17	475 2659	2	Hydraulikschlauch	High-pressure hose	1SN08-45000 M18x1,5 DKL
18	475 2696	2	Hydraulikschlauch	High-pressure hose	2SN08-1000-DKOL12/DKOL12-90°
19	475 4360	2	Zylinderhalter	Carrier for ram	50x15x160 2xD17 2xD14,5
20	575 2249	2	Hydraulikzylinder EW	Hydraulic ram SA	EZ30-110/320

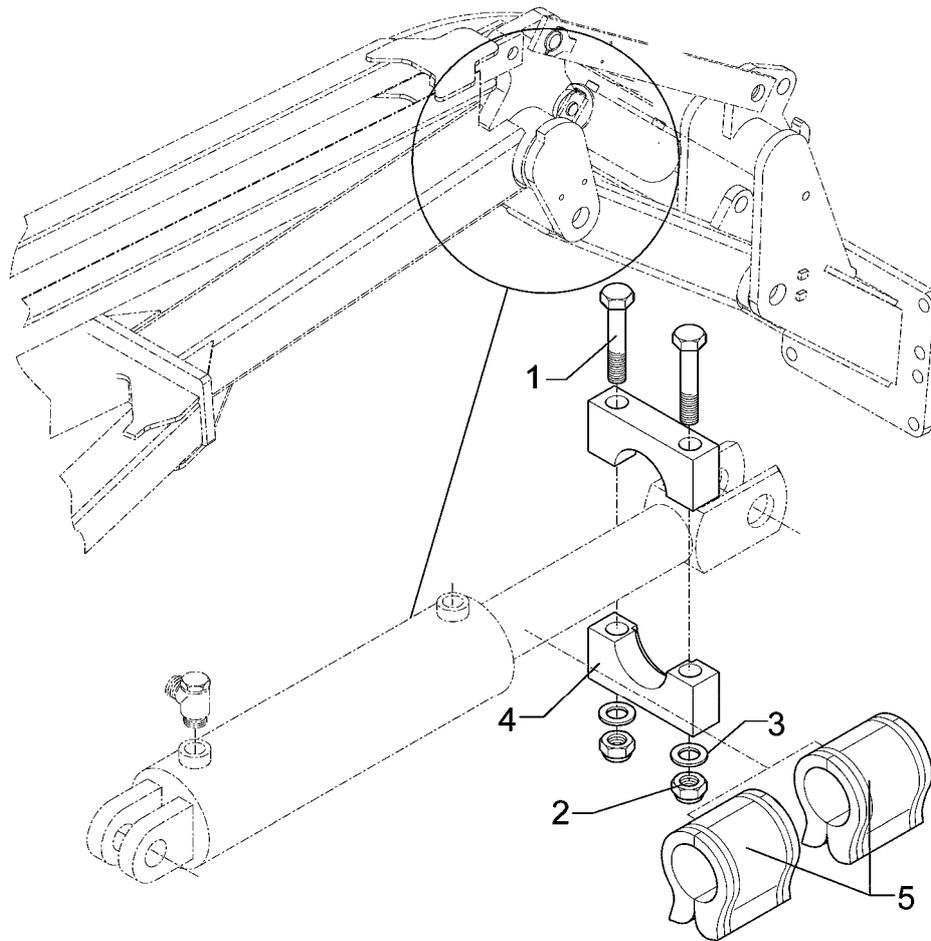

11.04

Pos.	Art.-Nr.	Stk.	Artikeltext / Description	Abmessung	
1	301 3457	2	Sechskantschraube DIN931-A	Bolt	M12x90-8.8 Zn
2	303 0934	2	Sicherungsmutter	Selflocking nut	DIN985-NM12-8 Zn
3	305 6137	2	Scheibe	Washer	13/25x3 DIN1441-St Zn
4	475 6102	2	Klemme	Clamp	80x34x20 D40
5	475 6103	2	Hydroclip	Hydroclip	D45/50x107,7

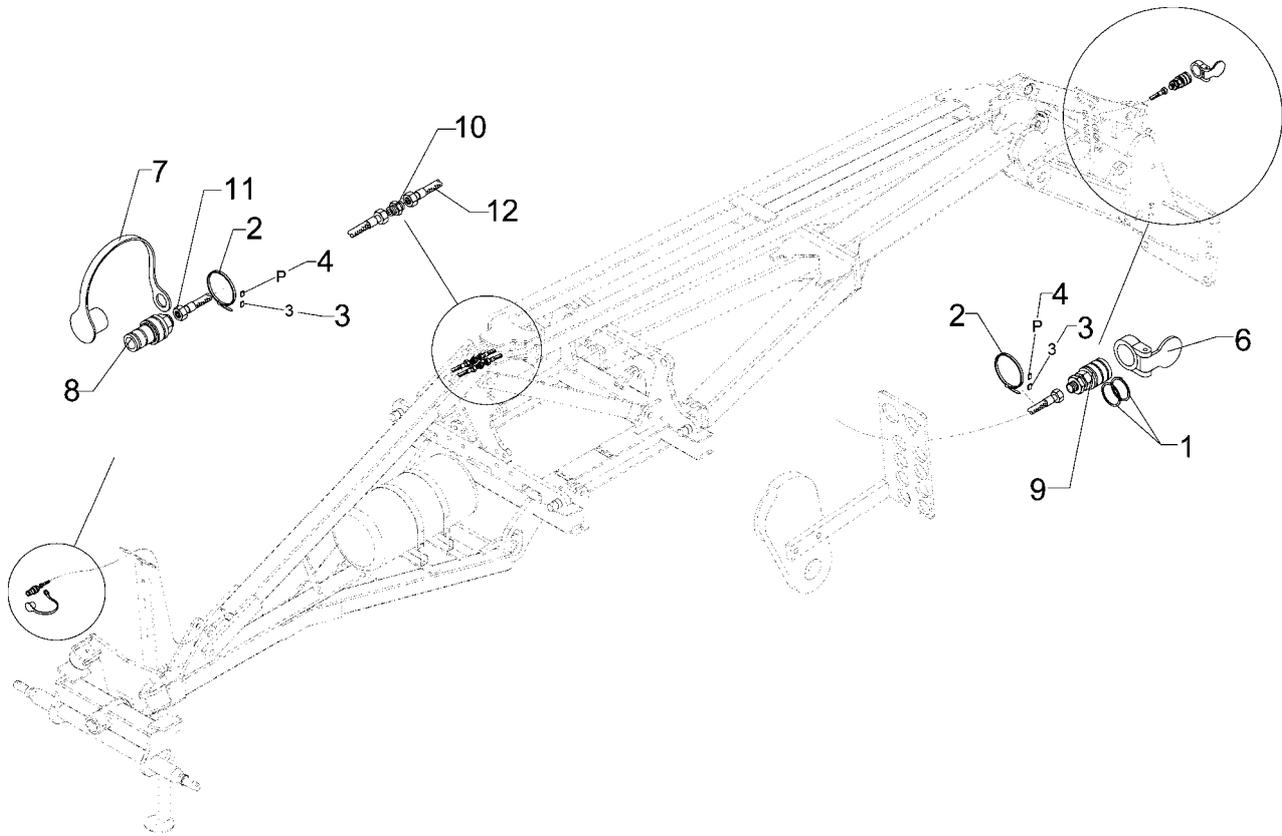

11.04

Pos.	Art.-Nr.	Stk.	Artikeltext / Description		Abmessung
1	305 8871	2	Sicherungsring	Securing ring	38x1,75 DIN471 Zn
2	325 1350	2	Spannband	Strap	6,3x254 VA
3	325 1503	2	EASY-READ Zeichen	EASY-READ sign	3
4	325 1511	2	EASY-READ Zeichen	EASY-READ sign	P
6	375 2101	1	Staubschutzklappe blau	Dust protection flap	BG 3 D38
7	375 2121	1	Staubkappe, blau	Cap	D26,5 Bg.3
8	375 2718	1	SVK-Stecker	SVK-socket	NW10-M18x1,5
9	375 2735	1	SVK-Muffe	SVK-socket	CEL12 M18x1,5 BG3
10	375 4110	1	Gerade Verschraubung	Nipple	x-G12-L M18x1,5
11	475 2624	1	Hydraulikschlauch	High-pressure hose	2SN10-4100 M18x1,5
12	475 2642	1	Hydraulikschlauch	High-pressure hose	1SN08-3900 DKOL-12L

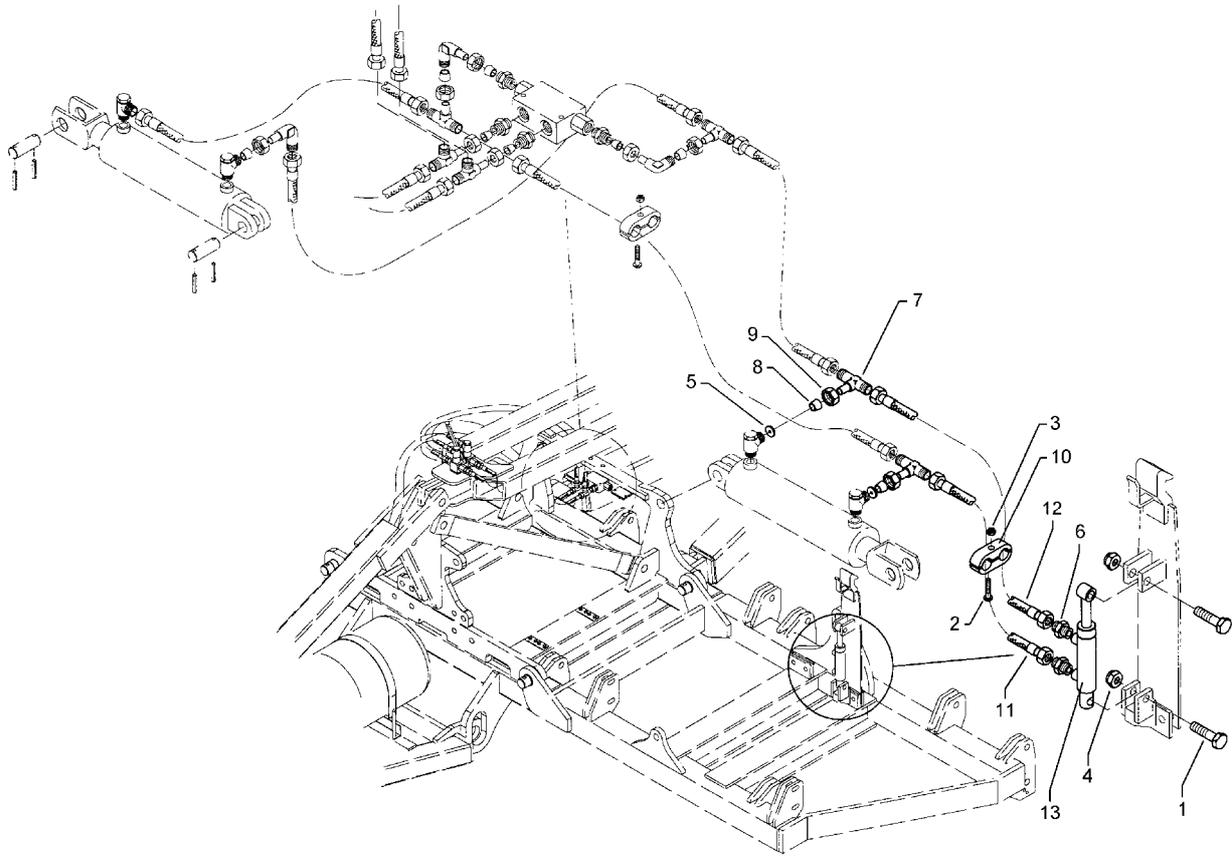

11.04

Pos.	Art.-Nr.	Stk.	Artikeltext / Description		Abmessung
1	301 5387	2	Sechskantschraube spz.	Bolt	M16x70-10.9
2	303 0935	2	Sicherungsmutter	Selflocking nut	DIN985-NM16-8 Zn
3	301 0306	1	Flachkopfschraube DIN85	Flatheaded bolt	M6x45-4,6 Zn
4	303 0931	1	Sicherungsmutter	Selflocking nut	DIN985-NM6-8 Zn
5	375 2172	2	Drosselplättchen	Throttle plate	D12x1,5 BO 1,0
6	375 4038	2	Einschraubverschraubung	Nipple	GE 12-LR R1/4
7	375 4490	2	Einstellbare T-Verschraubung	T-adjustable T-union	x-evT12-LM DKO24° M18x1,5
8	375 5110	3	Schneidring	Cutting ring	12-L/S Zn WD
9	375 5310	3	Überwurfmutter	Union nut	12L M18x1,5 Zn
10	375 9852	2	Schelle	Clamp	LNG-19/19PP 1/2
11	475 2614	1	Hydraulikschlauch	High-pressure hose	2SN10-1000 DKOL12/DKOL12
12	475 2616	1	Hydraulikschlauch	High-pressure hose	2SN10-1500 DKOL12/DKOL12
13	575 2336	1	Hydraulikzylinder	Ram	DZ25/18-10-240

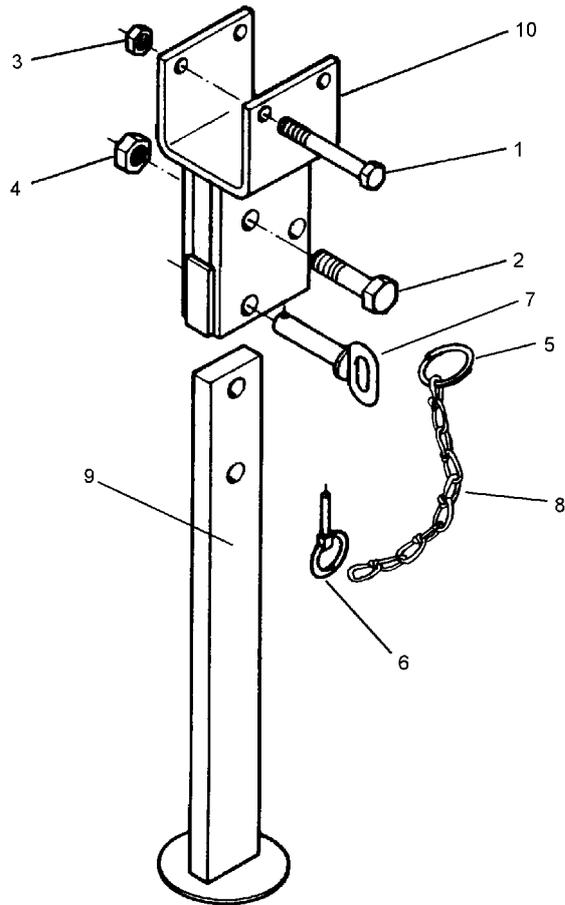

11.04

Pos.	Art.-Nr.	Stk.	Artikeltext / Description	Abmessung	
1	301 3550	2	Sechskantschraube DIN931-A	Bolt	M12x150-8.8
2	301 3870	1	Sechskantschraube spz.	Bolt	M16x65-10.9
3	303 0934	2	Sicherungsmutter	Selflocking nut	DIN985-NM12-8 Zn
4	303 0935	1	Sicherungsmutter	Selflocking nut	DIN985-NM16-8 Zn
5	305 8551	1	Federsicherung	Securing clip	41x3
6	311 9565	1	Klappstift	Securing pin	4,5mm
7	313 8140	1	Bolzen mit Griff	Pin with grip	GB D16x50,8/70 Zn
8	331 6130	1	Knotenkette	Chain	D2x150
9	429 2800	1	Abstellstütze	Stand	70x22x600
10	429 2801	1	Halter zur Abstellstütze	Holder for stand	Kompaktor K450-K600

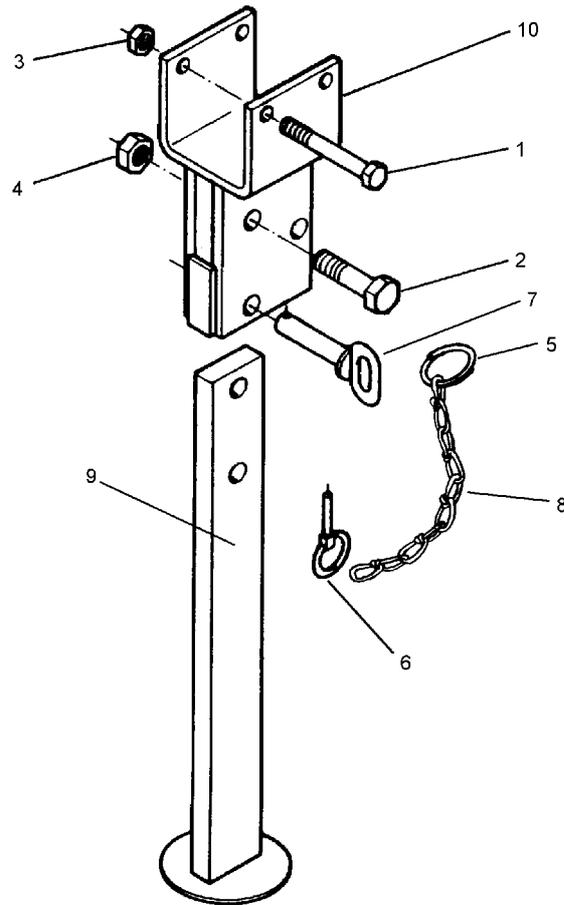

11.04

Pos.	Art.-Nr.	Stk.	Artikeltext / Description		Abmessung
1	301 3550	2	Sechskantschraube DIN931-A	Bolt	M12x150-8.8
2	301 3870	1	Sechskantschraube spz.	Bolt	M16x65-10.9
3	303 0934	2	Sicherungsmutter	Selflocking nut	DIN985-NM12-8 Zn
4	303 0935	1	Sicherungsmutter	Selflocking nut	DIN985-NM16-8 Zn
5	305 8551	1	Federsicherung	Securing clip	41x3
6	311 9565	1	Klappstift	Securing pin	4,5mm
7	313 8140	1	Bolzen mit Griff	Pin with grip	GB D16x50,8/70 Zn
8	331 6130	1	Knotenkette	Chain	D2x150
9	429 2800	1	Abstellstütze	Stand	70x22x600
10	429 2806	1	Halter zur Abstellstütze	Holder for stand	110x110

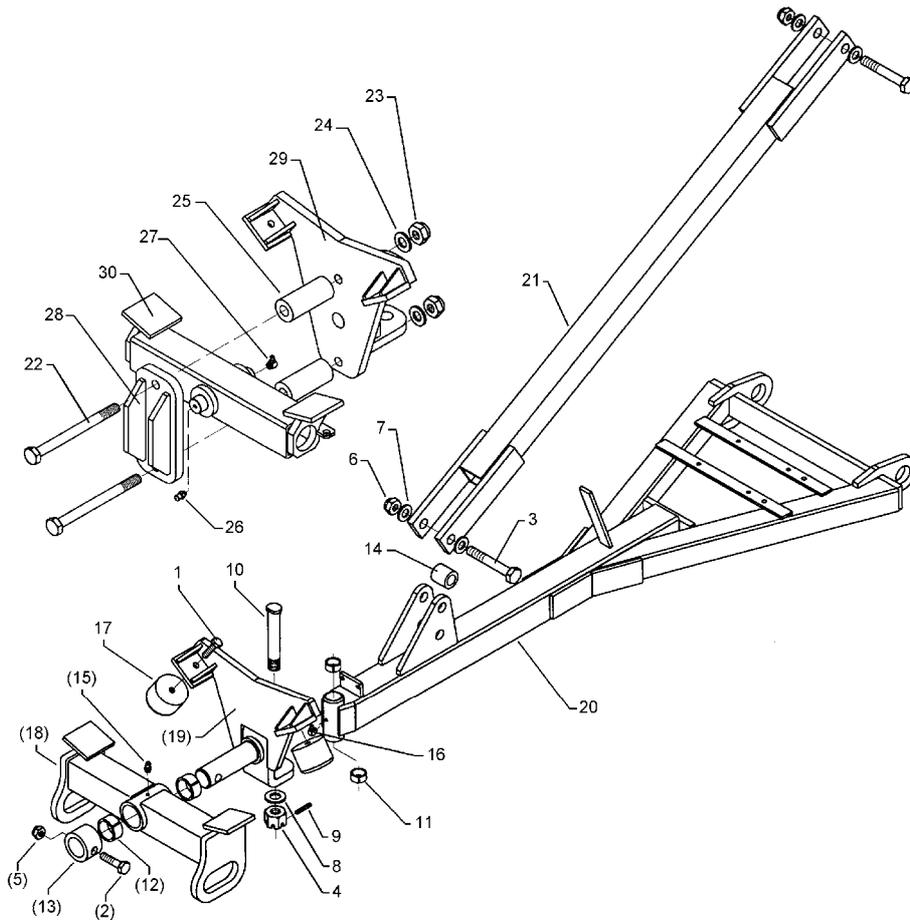

11.04

Pos.	Art.-Nr.	Stk.	Artikeltext / Description	Abmessung	
1	301 3682	2	Sechskantschraube DIN933	Screw	M16x30-8.8
2	301 4677	1	Sechskantschraube DIN931-A	Bolt	M24x120-8.8
3	301 4895	2	Sechskantschraube DIN931-A	Bolt	M30x190-8.8
4	303 0168	1	Kronenmutter	Castle nut	DIN935-M36
5	303 0937	1	Sicherungsmutter	Selflocking nut	DIN985-NM24-8 Zn
6	303 0938	2	Sicherungsmutter	Selflocking nut	DIN985-NM30-8 Zn
7	305 6326	5	Scheibe	Washer	60x31x6
8	305 6955	1	Scheibe	Washer	36/60x5 DIN126
9	309 6056	1	Spannhülse	Expansion bush	6x55-DIN1481
10	313 8128	1	Bolzen mit Kopf	Bolzen mit Kopf	KB D35x227/250-M36x50
11	317 3353	2	Einspannbuchse	Expansion bush	EG35/45x45-DIN1498
12	317 3393	2	Einspannbuchse	Expansion bush	EG60/70x50-DIN1498
13	317 8665	1	Stelling	Adjusting ring	D90/60,1x60-D24
14	317 6881	1	Röhrchen	Tube	51x8,8x54
15	323 6348	1	Schmiernippel	Grease nipple	AM10x1 DIN71412
16	323 6349	1	Schmiernippel	Grease nipple	CM10x1 DIN71412-90°
17	329 5020	2	Gummipuffer	Rubber buffer	D100x75 M16 70Shore
18	440 8568	1	Schienenträger	Carrier	Smaragd 9 KA
19	440 8581	1	Kreuzgelenk zur Deichsel	Cross union	Smaragd 9 KA
20	440 9130	1	Deichsel	Deichsel	Smaragd 9 KA B
21	450 8536	1	Strebe Smaragd 9/KA B	Support Smaragd 9/KA B	90x90x1844
22	301 4826	2	Sechskantschraube DIN931-A	Bolt	M24x220-8.8
23	303 0937	2	Sicherungsmutter	Selflocking nut	DIN985-NM24-8 Zn
24	305 6253	2	Scheibe	Washer	B25 DIN125-St
25	317 6959	2	Röhrchen	Tube	60,3x16x141,5 +0,5
26	323 6348	1	Schmiernippel	Grease nipple	AM10x1 DIN71412

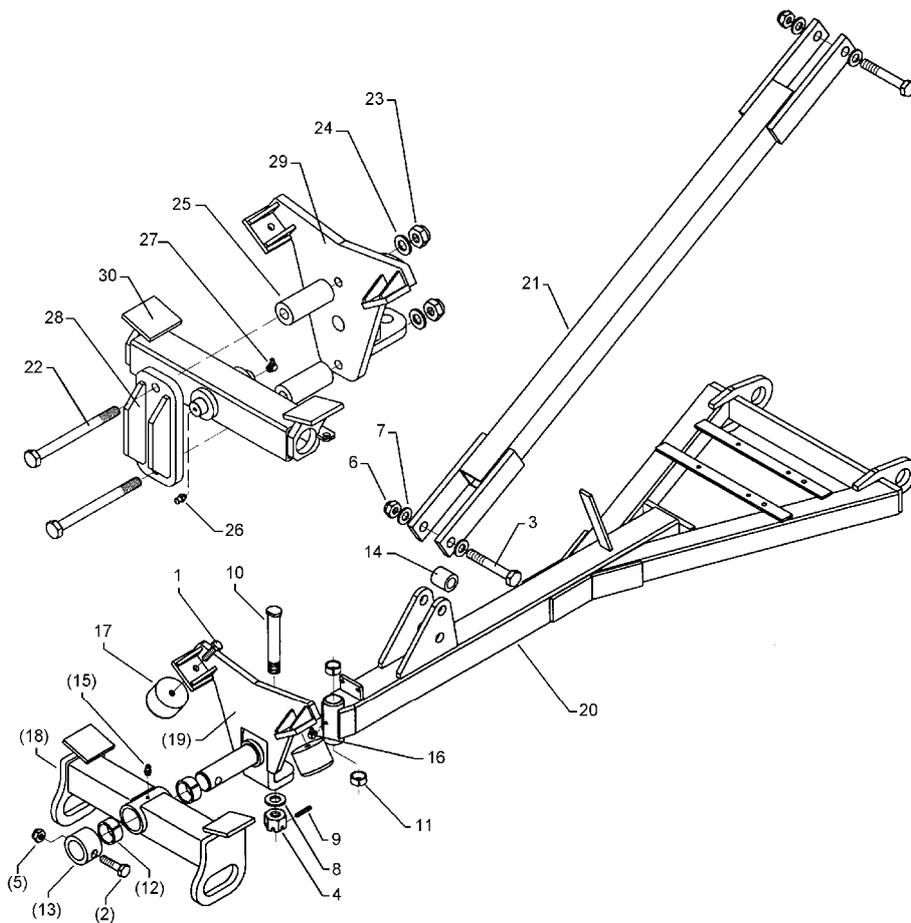

11.04

Pos.	Art.-Nr.	Stk.	Artikeltext / Description	Abmessung	
27	323 6349	1	Schmiernippel	Grease nipple	CM10x1 DIN71412-90°
28	440 8583	1	Brücke	Clamp plate	140x25x340 D40/24
29	440 8585	1	Konsole	Bracket	429x25x494 D40/24
30	440 8587	1	Schienenträger Smaragd 9KA	Carrier	100x100x580 D69

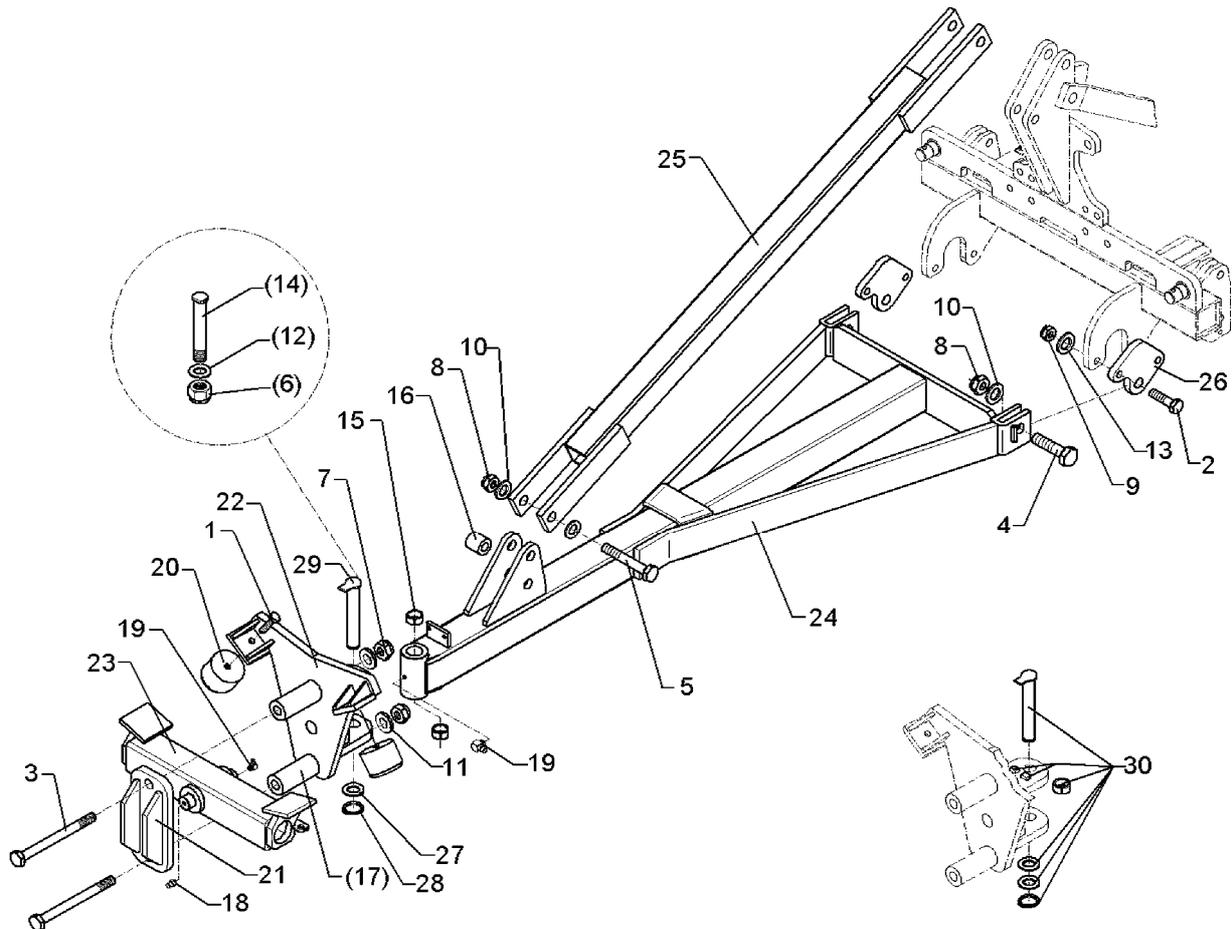

11.04

Pos.	Art.-Nr.	Stk.	Artikeltext / Description	Abmessung	
1	301 3682	2	Sechskantschraube DIN933	Screw	M16x30-8.8
2	301 5390	4	Sechskantschraube spz.	Bolt	M20x65-12.9
3	301 4826	2	Sechskantschraube DIN931-A	Bolt	M24x220-8.8
4	301 4873	2	Sechskantschraube spz.	Bolt	M30x90-8.8
5	301 4896	2	Sechskantschraube spz.	Bolt	M30x190-8.8
6	303 0168	1	Kronenmutter	Castle nut	DIN935-M36
7	303 0937	2	Sicherungsmutter	Selflocking nut	DIN985-NM24-8 Zn
8	303 0938	4	Sicherungsmutter	Selflocking nut	DIN985-NM30-8 Zn
9	303 0978	4	Sechskantmutter	Nut	M20 DIN934-8
10	305 6229	6	Scheibe	Washer	45x31x5
11	305 6253	2	Scheibe	Washer	B25 DIN125-St
12	305 6955	1	Scheibe	Washer	36/60x5 DIN126
13	305 9888	4	Federring	Spring ring	20 DIN127-A
14	313 8128	1	Bolzen mit Kopf	Bolzen mit Kopf	KB D35x227/250-M36x50
15	317 3353	2	Einspannbuchse	Expansion bush	EG35/45x45-DIN1498
16	317 6881	1	Röhrchen	Tube	51x8,8x54
17	317 6959	2	Röhrchen	Tube	60,3x16x141,5 +0,5
18	323 6348	1	Schmiernippel	Grease nipple	AM10x1 DIN71412
19	323 6349	2	Schmiernippel	Grease nipple	CM10x1 DIN71412-90°
20	329 5020	2	Gummipuffer	Rubber buffer	D100x75 M16 70Shore
21	440 8583	1	Brücke	Clamp plate	140x25x340 D40/24
22	440 8585	1	Konsole	Bracket	429x25x494 D40/24
23	440 8587	1	Schienenträger Smaragd 9KA	Carrier	100x100x580 D69
24	440 9132	1	Deichsel Smaragd	Two-bar	9 KA-B
25	450 8536	1	Strebe Smaragd 9/KA B	Support Smaragd 9/KA B	90x90x1844
26	461 6059	2	Platte	Plate	20x173x198 1xD30 2xD20

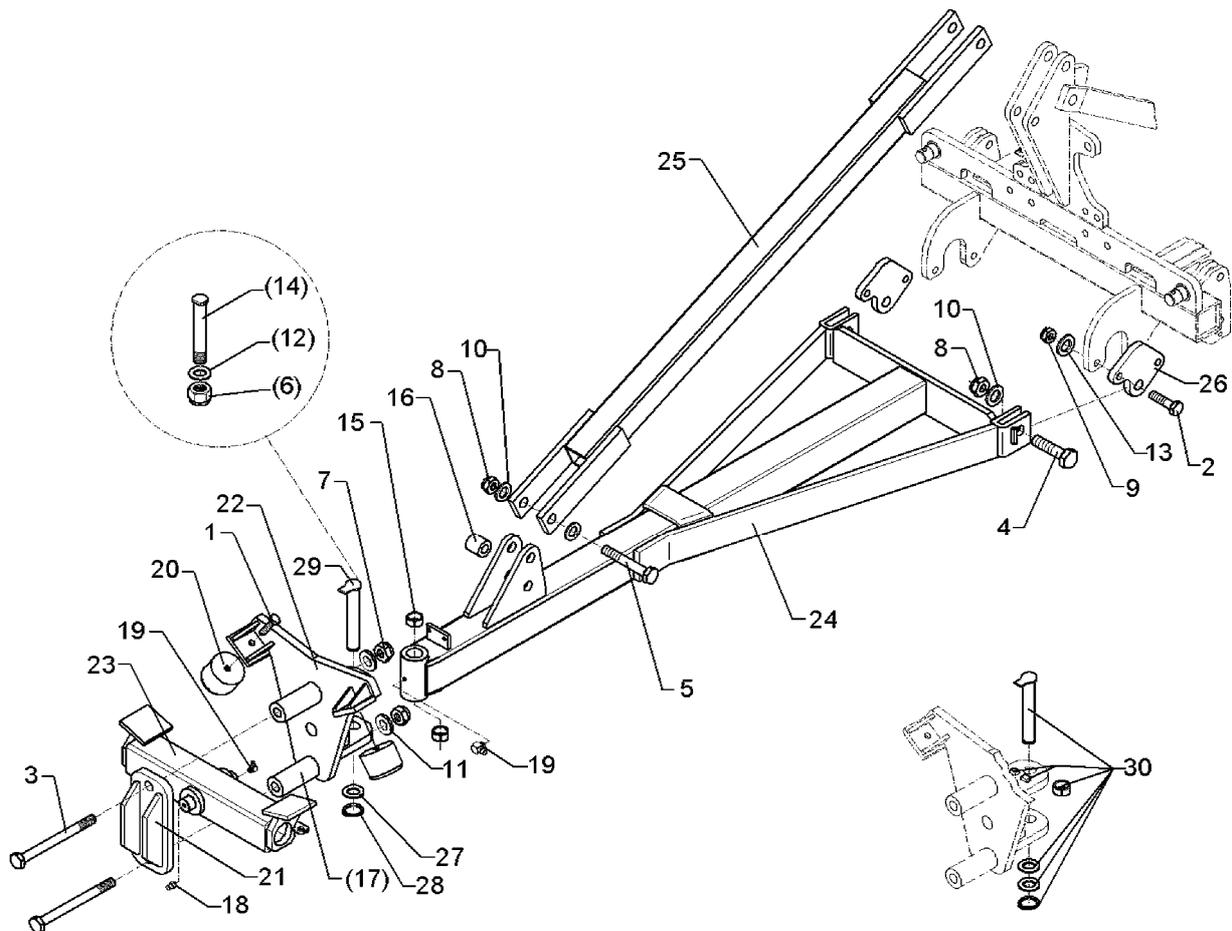

11.04

Pos.	Art.-Nr.	Stk.	Artikeltext / Description		Abmessung
27	305 2072	2	Paßscheibe	Shim	35x45x1,0 DIN988
28	305 8873	1	Sicherungsring	Securing ring	35x2,5 DIN471
29	313 3517	1	Bolzen mit Verdrehsicherung	Pin with stop	FN D35x197/215
30	540 9131	1	Umrüstsatz Kreuzgelenk Bolzen	Conversion set	KA D35x210

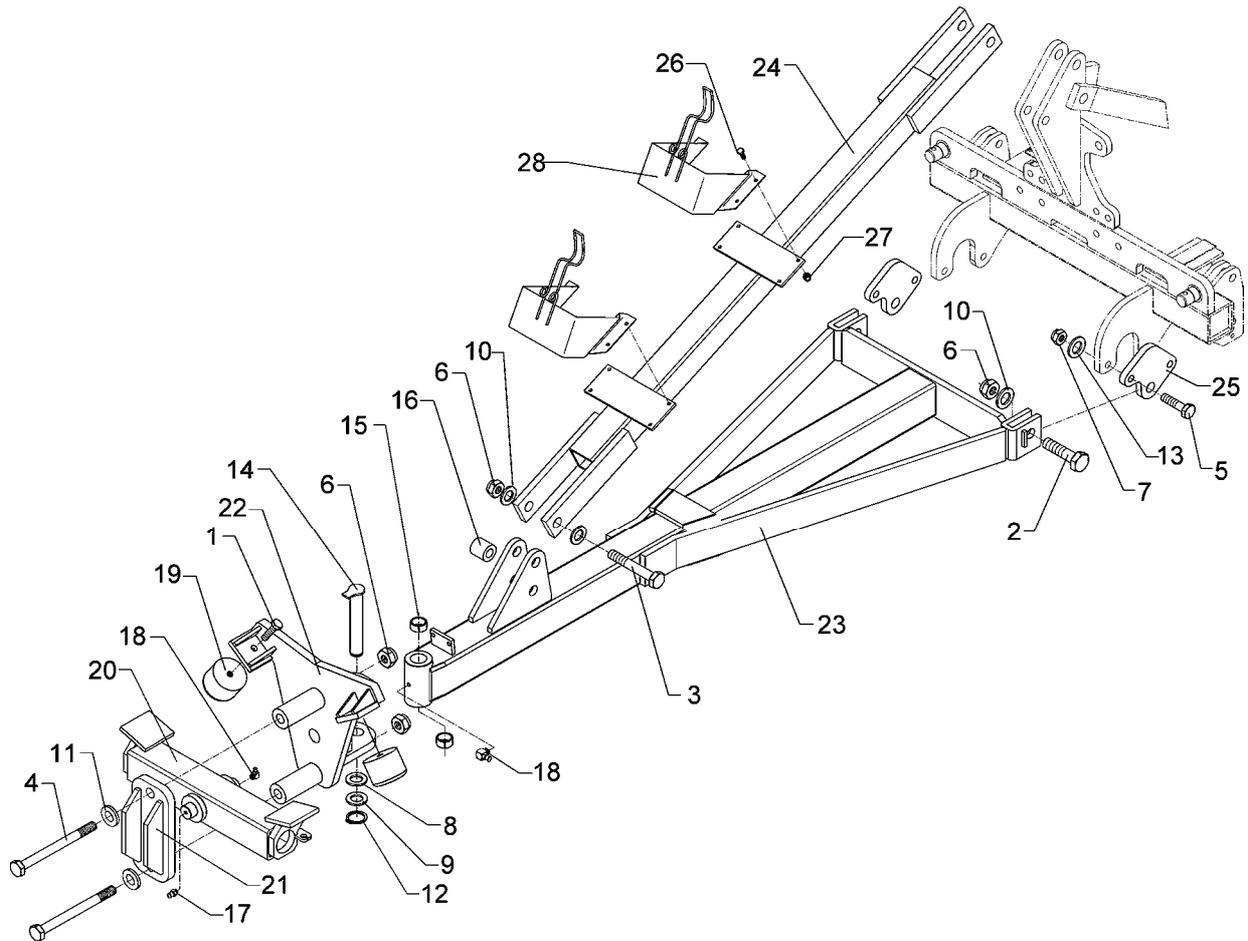

11.04

Pos.	Art.-Nr.	Stk.	Artikeltext / Description	Abmessung	
1	301 3682	2	Sechskantschraube DIN933	Screw	M16x30-8.8
2	301 4873	2	Sechskantschraube spz.	Bolt	M30x90-8.8
3	301 4896	2	Sechskantschraube spz.	Bolt	M30x190-8.8
4	301 4902	2	Sechskantschraube DIN931-A	Bolt	M30x240-8.8 Zn
5	301 5390	4	Sechskantschraube spz.	Bolt	M20x65-12.9
6	303 0938	6	Sicherungsmutter	Selflocking nut	DIN985-NM30-8 Zn
7	303 0978	4	Sechskantmutter	Nut	M20 DIN934-8
8	305 2125	1	Paßscheibe	Shim	45x55x1,0 DIN988
9	305 2252	1	Stützscheibe	Supporting washer	S 45x55x3 DIN988
10	305 6229	6	Scheibe	Washer	45x31x5
11	305 6326	2	Scheibe	Washer	60x31x6
12	305 8876	1	Sicherungsring	Securing ring	45x2,5 DIN471
13	305 9888	4	Federring	Spring ring	20 DIN127-A
14	313 4524	1	Bolzen mit Verdrehsicherung	Pin with stop	FN D45x235/259
15	317 3430	2	Einspannbuchse	Expansion bush	EG45/55x40-DIN1498
16	317 6881	1	Röhrchen	Tube	51x8,8x54
17	323 6348	1	Schmiernippel	Grease nipple	AM10x1 DIN71412
18	323 6349	2	Schmiernippel	Grease nipple	CM10x1 DIN71412-90°
19	329 5020	2	Gummipuffer	Rubber buffer	D100x75 M16 70Shore
20	440 8587	1	Schienenträger Smaragd 9KA	Carrier	100x100x580 D69
21	440 8588	1	Brücke	Clamp plate	140x25x270 D40/30 KG45
22	440 8589	1	Konsole	Bracket	411x25x494 D40/30 KG45
23	440 9139	1	Deichsel Smaragd	Twobar	9 KA-B KG45
24	450 8536	1	Strebe Smaragd 9/KA B	Support Smaragd 9/KA B	90x90x1844
25	461 6059	2	Platte	Plate	20x173x198 1xD30 2xD20
26	301 3059	8	Sechskantschraube DIN933	Screw	M8x20-8.8

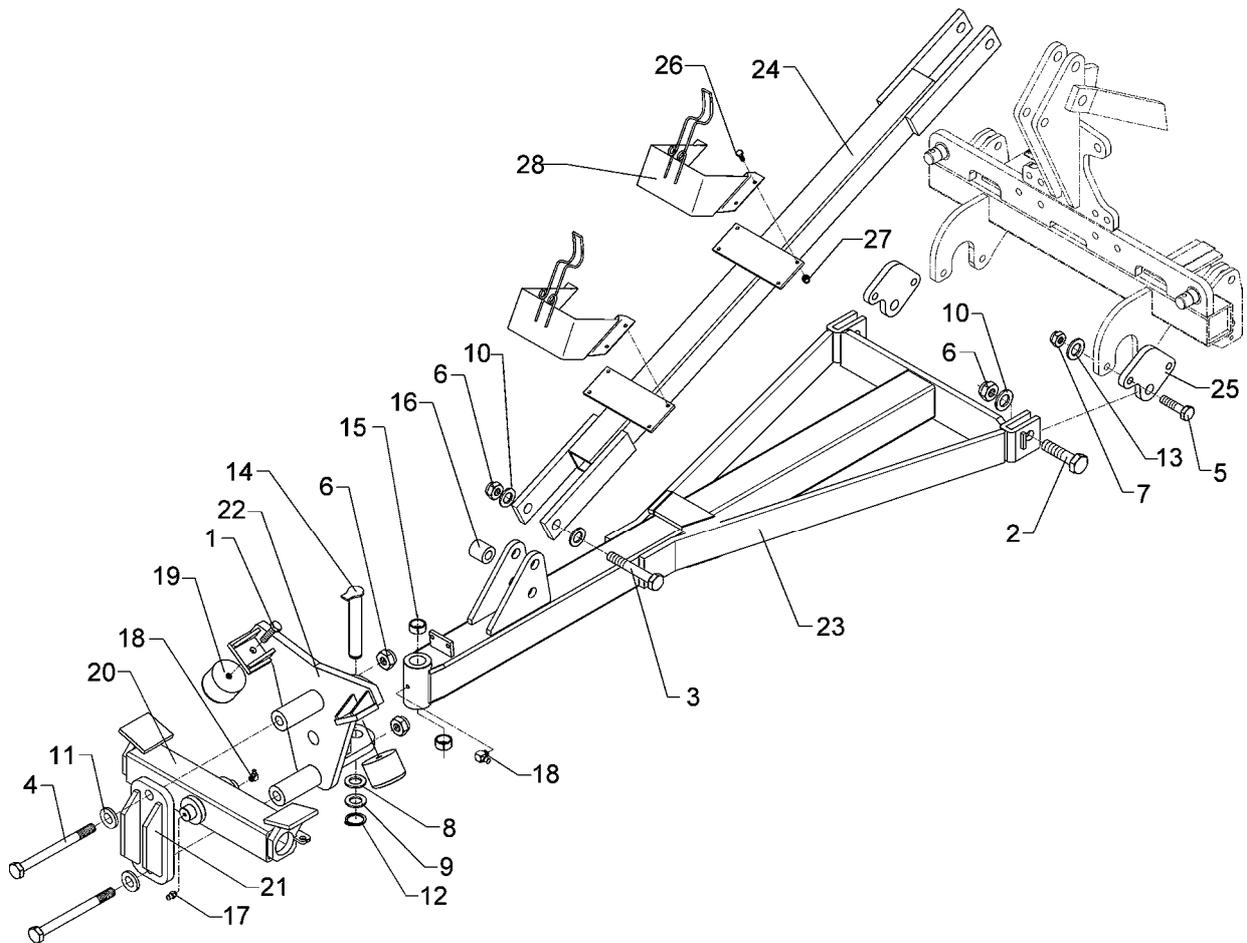

11.04

Pos.	Art.-Nr.	Stk.	Artikeltext / Description	Abmessung	
27	303 0932	8	Sicherungsmutter	Selflocking nut	DIN985-NM8-8 Zn
28	321 9943	2	Halter zum Unterlegekeil	Carrier for wedge	NG53 122853.001

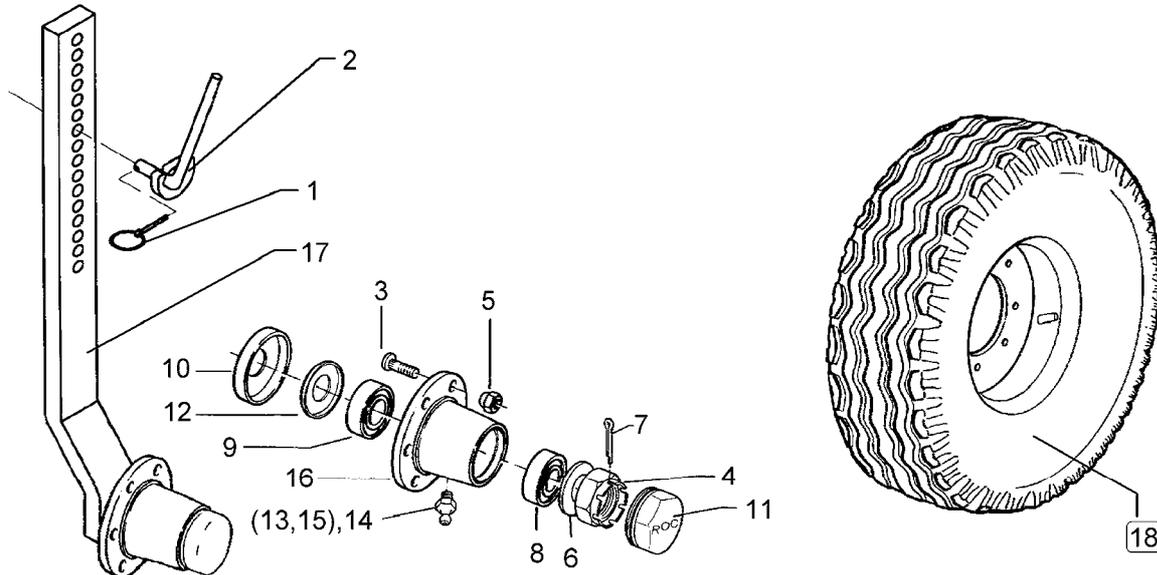

11.04

Pos.	Art.-Nr.	Stk.	Artikeltext / Description	Abmessung	
1	311 9565	1	Klappstift	Securing pin	4,5mm
2	321 6963	1	Exzenterhebel	Eccentric lever	D16x230/69x14x50/33
3	301 6414	5	Radschraube	Wheel bolt	M14x1,5x40-D17-Zn
4	303 0139	1	Kronenmutter	Castle nut	DIN937-M24x2
5	303 6413	5	Radmutter	Wheel nut	M14x1,5 Zn
6	305 6253	1	Scheibe	Washer	B25 DIN125-St
7	311 7617	1	Splint	Peg	4x40 DIN94-St Zn
8	319 9116	1	Kegelrollenlager	Bearing	30206.
9	319 9151	1	Kegelrollenlager	Bearing	30209.
10	323 0413	1	Hüllscheibe	Cover washer	D100/45x12
11	323 1321	1	Schraubkappe	Cap	D63,5x40
12	323 1802	1	Nilos-Ring	Nilos ring	30209 AV
13	323 6345	1	Schmiernippel	Grease nipple	LAM 6 DIN71412
14	323 6353	1	Schmiernippel	Grease nipple	BM8x1 DIN71412-6kt. 45°
15	323 6363	1	Schmiernippel	Grease nipple	1/4 SAE
16	449 8892	1	Nabe	Hub	5/140/93
17	547 2520	1	Radhalm mit Lagerung	Wheel stalk with bearing	70x30x837 5/94/140
18	549 8849	1	Rad 5/94/140 D14	Wheel 5/94/140 D14	10.0/80-12 8PR ET-25

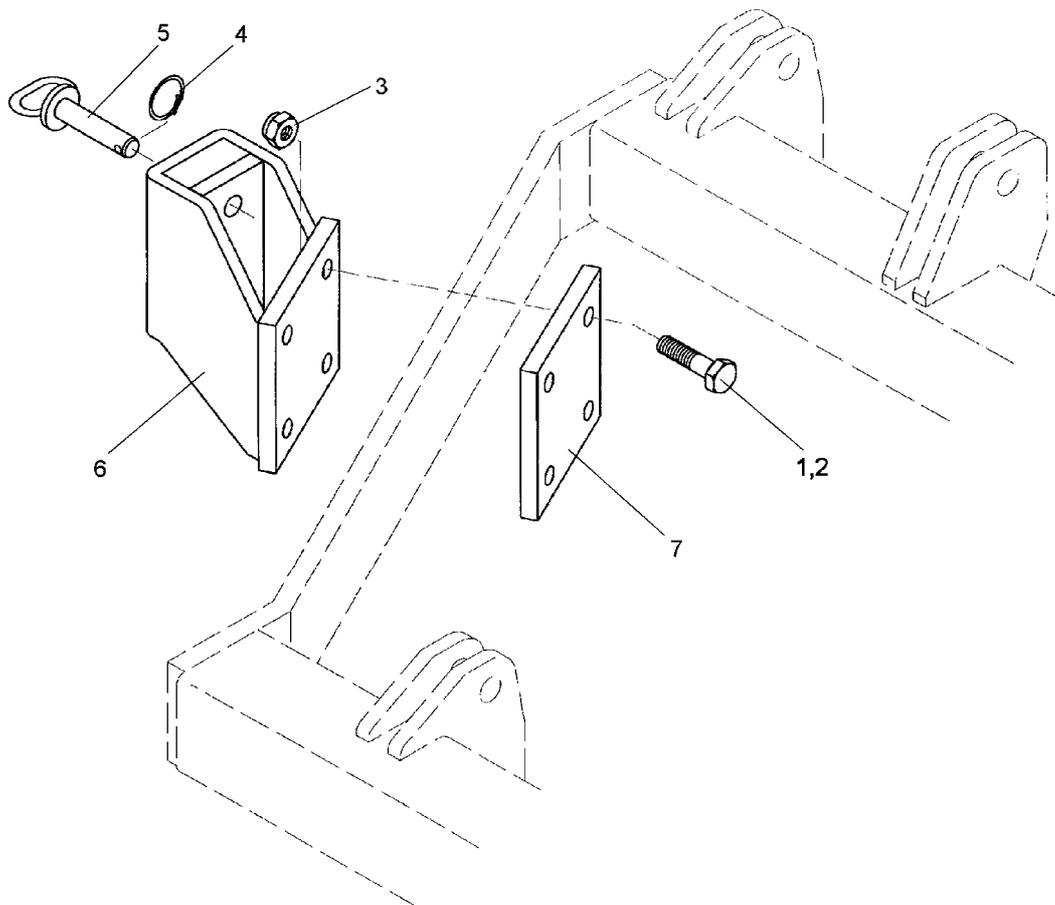

11.04

Pos.	Art.-Nr.	Stk.	Artikeltext / Description		Abmessung
1	301 3884	4	Sechskantschraube DIN931-A	Bolt	M16x70-8.8
2	301 3903	4	Sechskantschraube DIN931-A	Bolt	M16x75-8.8
3	303 0935	4	Sicherungsmutter	Selflocking nut	DIN985-NM16-8 Zn
4	305 8551	1	Federsicherung	Securing clip	41x3
5	313 8143	1	Bolzen mit Griff	Pin with grip	GB D16x77/90
6	447 7474	1	Radkonsole	Wheel bracket	70x30 RE Smaragd 9 K
7	459 9337	1	Klemmplatte	Clamping plate	15x160x150 4xD17

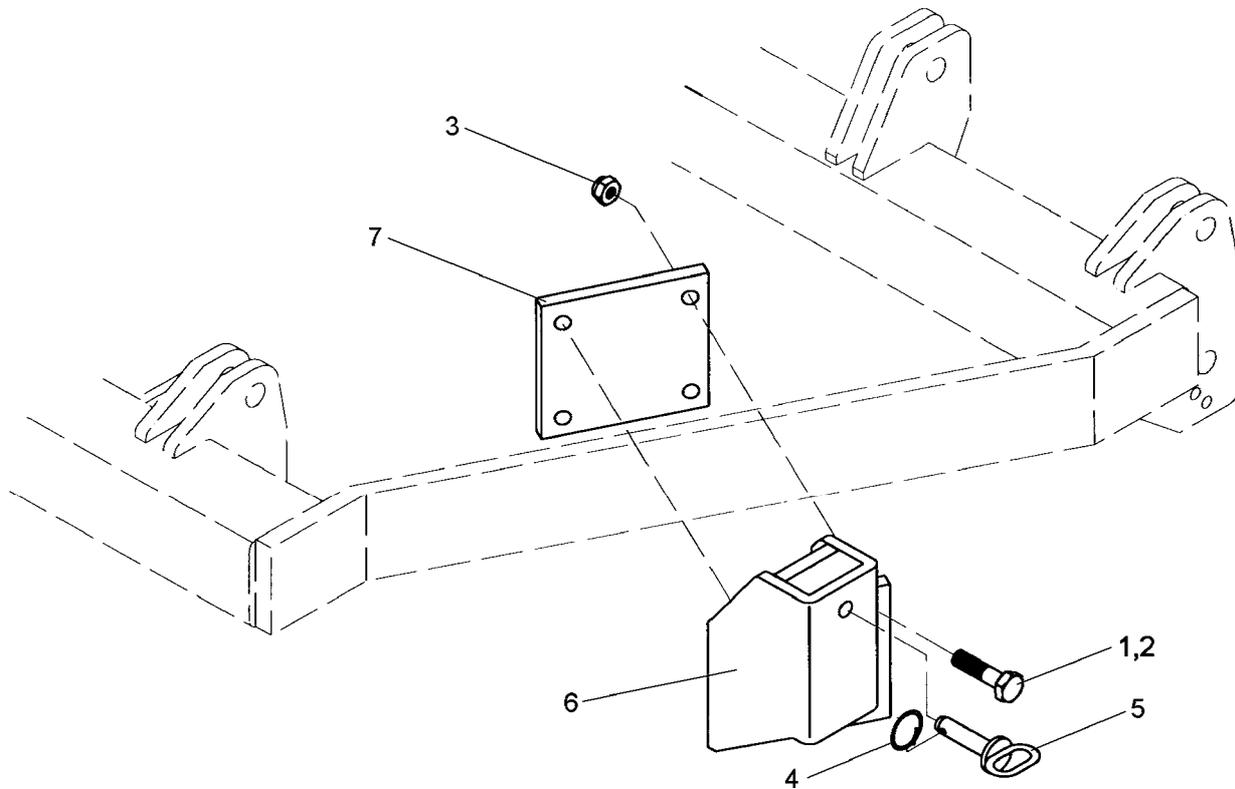

11.04

Pos.	Art.-Nr.	Stk.	Artikeltext / Description		Abmessung
1	301 3884	4	Sechskantschraube DIN931-A	Bolt	M16x70-8.8
2	303 0935	4	Sicherungsmutter	Selflocking nut	DIN985-NM16-8 Zn
3	305 8551	1	Federsicherung	Securing clip	41x3
4	313 8143	1	Bolzen mit Griff	Pin with grip	GB D16x77/90
5	447 7475	1	Radkonsole	Wheel bracket	70x30 LI Smaragd 9 K
6	459 9337	1	Klemmplatte	Clamping plate	15x160x150 4xD17

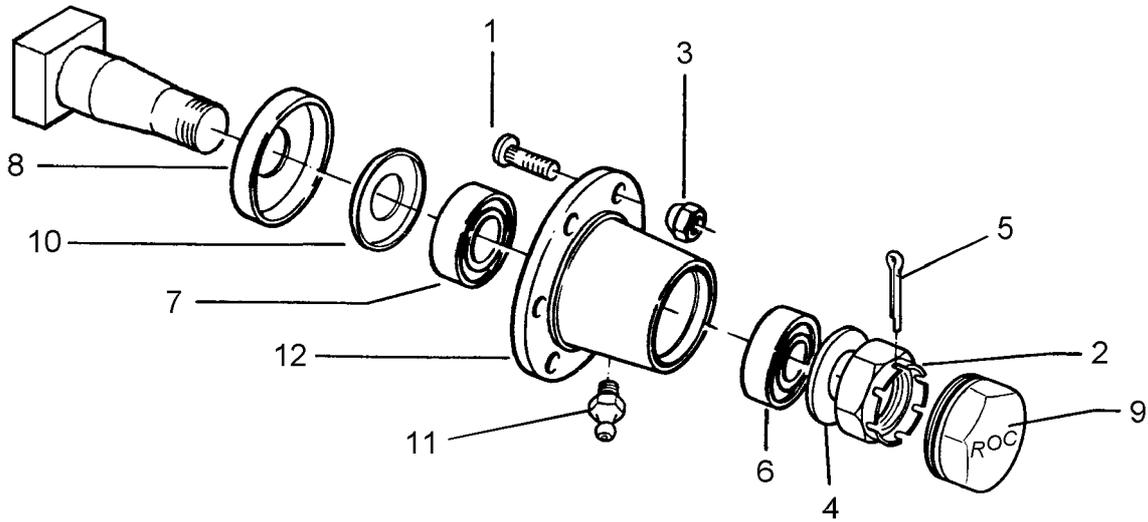

11.04

Pos.	Art.-Nr.	Stk.	Artikeltext / Description		Abmessung
1	301 6421	8	Radschraube	Wheel bolt	M18x1,5x52-D19 REB
2	303 0251	1	Kronenmutter	Castle nut	DIN937-M42x2
3	303 6416	8	Radmutter	Wheel nut	M18x1,5 Zn
4	305 6420	1	Scheibe	Washer	D46/70x4
5	311 7649	1	Splint	Peg	6,3x63 DIN94-St Zn
6	319 9059	1	Kegelrollenlager	Bearing	30215.
7	319 9158	1	Kegelrollenlager	Bearing	32211.
8	323 0415	1	Hüllscheibe	Cover washer	D148/75x13
9	323 1324	1	Schraubkappe	Cap	M100x1,5x52
10	323 1804	1	Nilos-Ring	Nilos ring	30215 AV
11	323 6345	1	Schmiernippel	Grease nipple	LAM 6 DIN71412
12	449 8897	1	Nabe	Hub	8/275 ROC

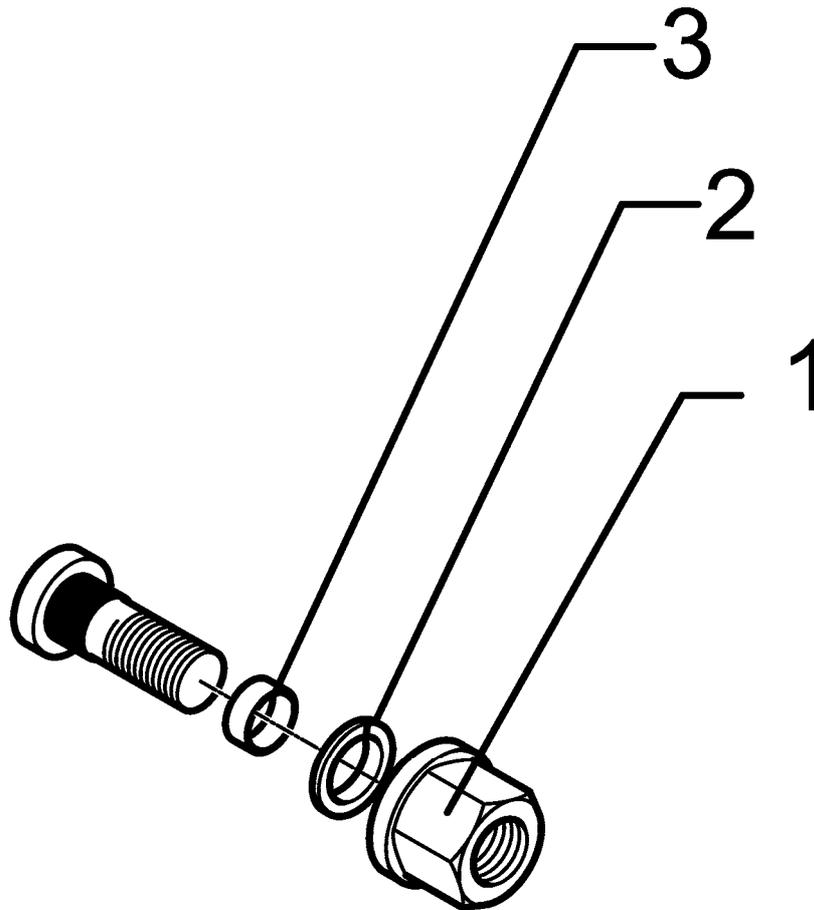

11.04

Pos.	Art.-Nr.	Stk.	Artikeltext / Description	Abmessung	
1	303 6420	16	Radmutter	Wheel nut	B18 DIN74361
2	305 9932	16	Federring mit Kugelbund	Spring ring	C20 DIN74361
3	317 6646	16	Hülse	Bushing	D20x1x8

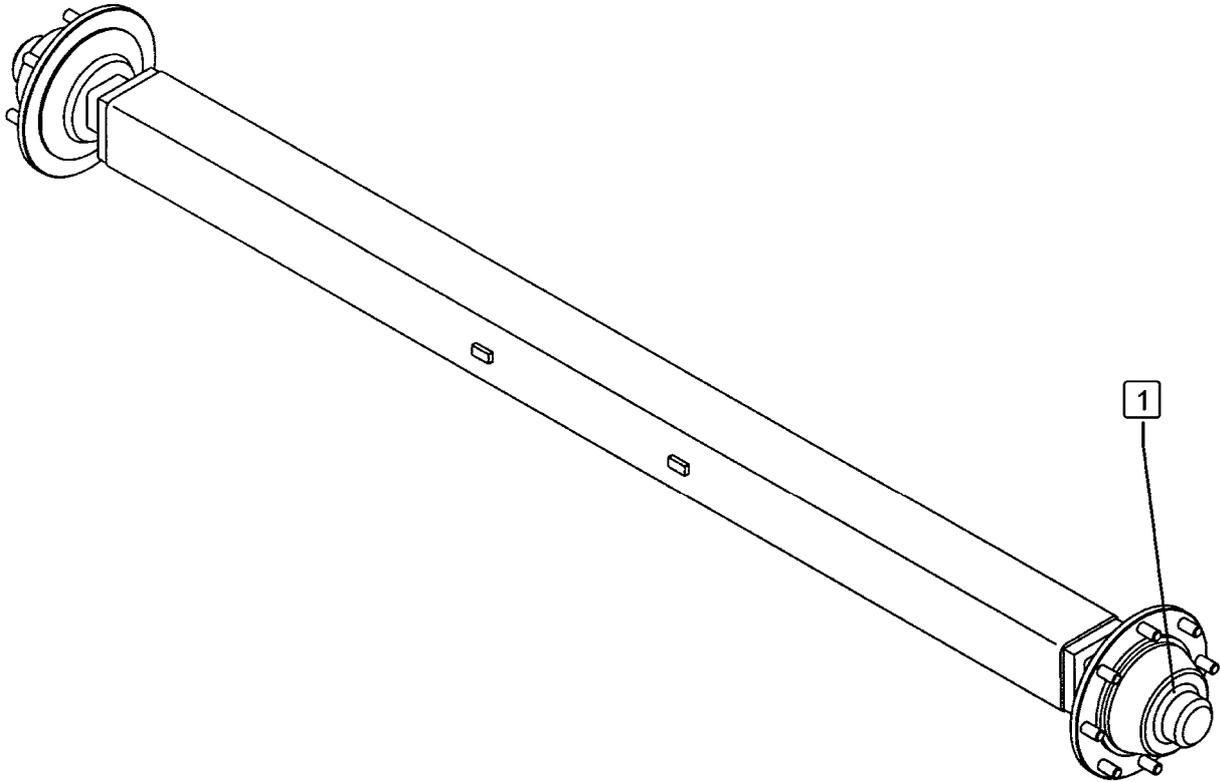

11.04

Pos.	Art.-Nr.	Stk.	Artikeltext / Description	Abmessung	
1	549 8897	2	Lagerung	Bearing	8/220/275 M18 80x80

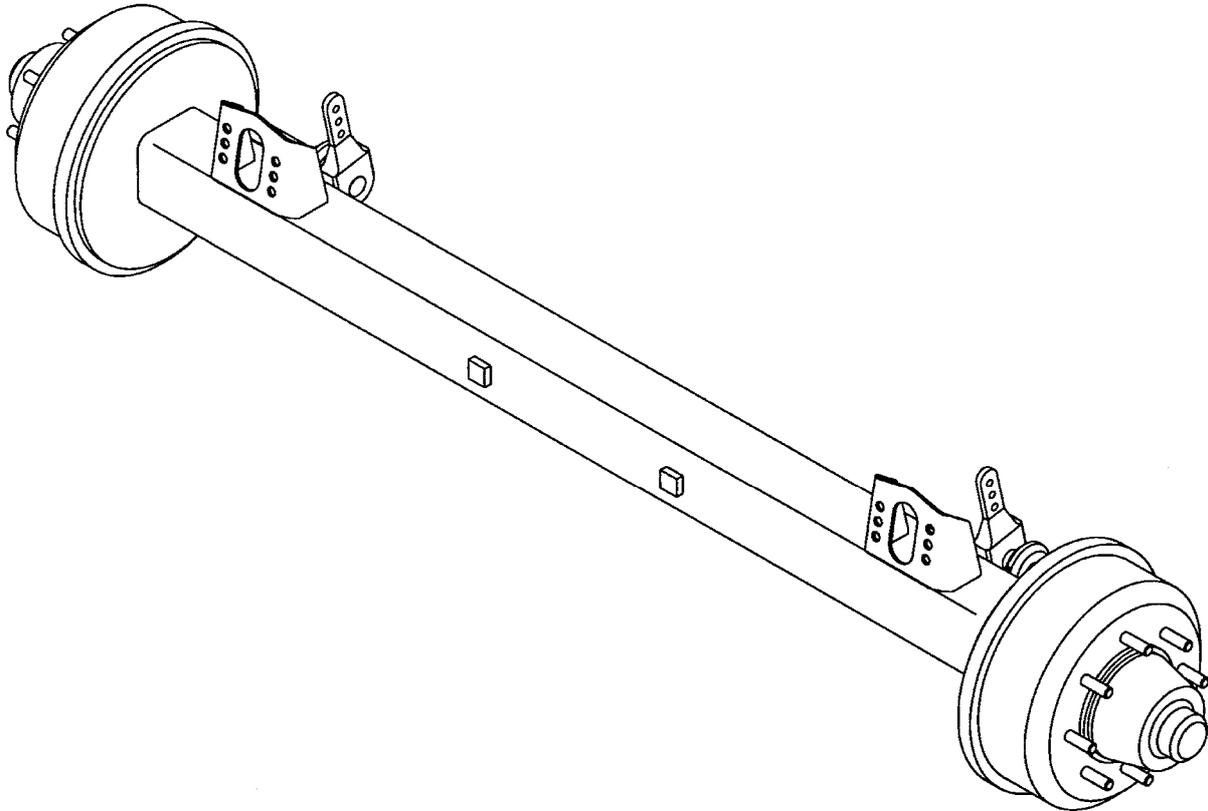

11.04

Pos.	Art.-Nr.	Stk.	Artikeltext / Description		Abmessung
1	301 6423	16	Radbolzen	Wheel pin	M20x1,5x94
2	301 6750	12	Sechskantschraube DIN933	Screw	M8x20-8.8 Zn
3	303 0260	2	Kronenmutter	Castle nut	M52x2
4	303 1011	12	Sechskantmutter	Nut	M8 DIN934-8 Zn
5	303 6421	16	Flachbundmutter	Nut	M20x1,5 Zn
6	303 6425	16	Radmutter	Wheel nut	M20x1,5 Zn
7	305 2055	2	Paßscheibe	Shim	30x42x2,0 DIN988
8	305 2072	2	Paßscheibe	Shim	35x45x1,0 DIN988
9	305 6451	2	Scheibe mit Nase	Washer	D76/53x6
10	305 8866	2	Sicherungsring	Securing ring	29x2 02.5603.29.90
11	305 8870	2	Sicherungsring	Securing ring	34x1,5 DIN471
12	305 9690	12	Federscheibe	Spring washer	B8 DIN137 Zn
13	305 9932	16	Federring mit Kugelbund	Spring ring	C20 DIN74361
14	309 1324	16	Kerbstift	Notched pin	5x10
15	311 7667	2	Splint	Peg	8x80 DIN94-St Zn
16	317 8110	2	Buchse	Bush	D70/32x42
17	319 1128	2	Lagerhalter	Bearing holder	5xD8 TK87 A
18	319 1129	2	Lagerhalter	Bearing holder	5xD8 TK87 A
19	319 9207	2	Kegelrollenlager	Bearing	33116
20	319 9210	2	Kegelrollenlager	Bearing	33213.
21	323 0217	2	Dichtscheibe Kunststoff	Seal washer	D160/120x3
22	323 0218	2	Dichtscheibe Kunststoff	Seal washer	D155/120x3
23	323 1326	2	Schraubkappe	Cap	M125x2 BPW
24	323 6348	2	Schmiernippel	Grease nipple	AM10x1 DIN71412
25	323 6349	2	Schmiernippel	Grease nipple	CM10x1 DIN71412-90°
26	329 8554	2	Zugfeder	Spring	6x24x150

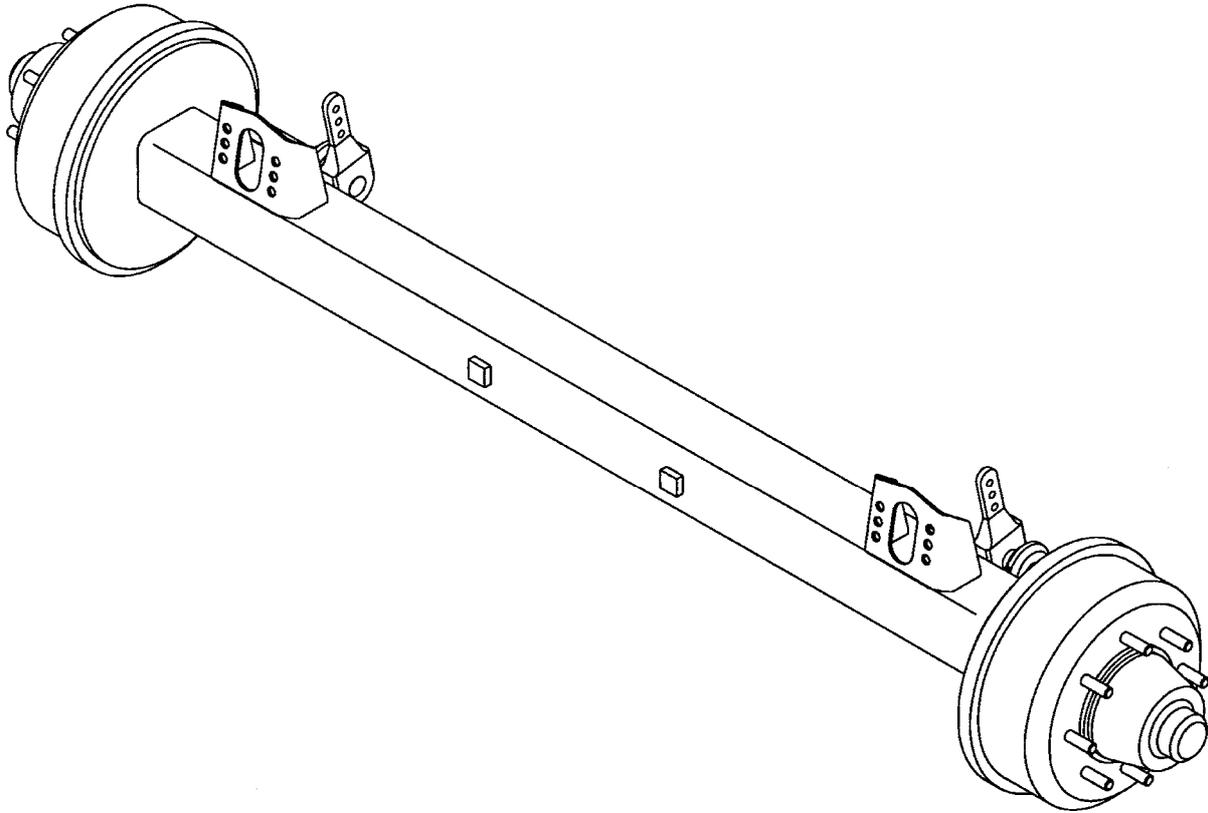

11.04

Pos.	Art.-Nr.	Stk.	Artikeltext / Description		Abmessung
27	329 8555	2	Zugfeder	Spring	4x16x180
28	450 6781	2	Bremsbackenbolzen	Brake-shoe mounting bolt	M24x1,5x144 kpl.
29	450 6802	4	Bremsbacke mit Belag	Brake-shoe with lining	D400x120
30	450 6846	2	Gestängesteller	Linkage control element	D29x180 3xD14
31	450 6852	2	Bremsnockenwelle	Brake camshaft	D32x400 A302
32	450 6904	2	Radnabe	Wheel hub	8/220/275 D20 M125x2
33	450 6905	2	Bremstrommel	Brake drum	D400x120

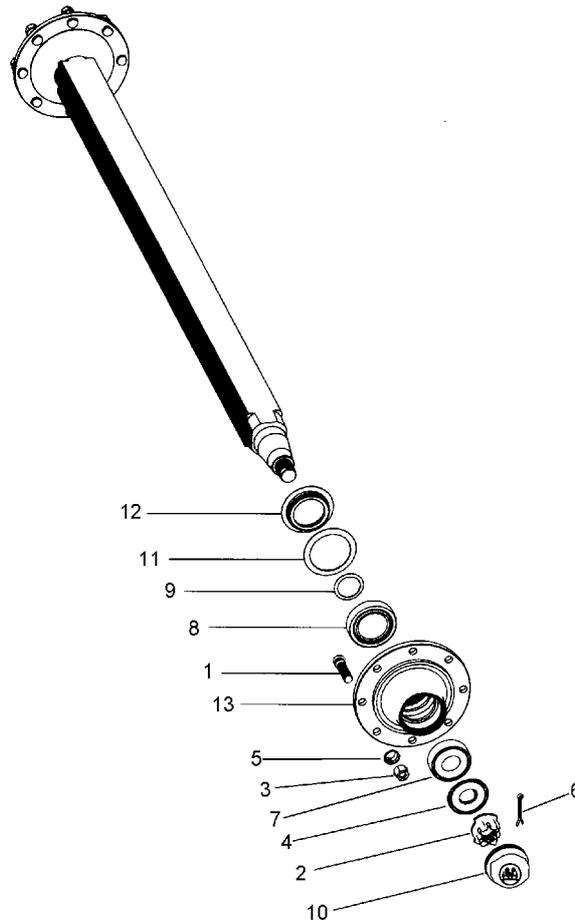

11.04

Pos.	Art.-Nr.	Stk.	Artikeltext / Description		Abmessung
1	301 6424	16	Radbolzen	Wheel pin	M20x1,5x54
2	303 0242	2	Kronenmutter	Castle nut	M36x1,5 600.008.04
3	303 6421	16	Flachbundmutter	Nut	M20x1,5 Zn
4	305 6450	2	Scheibe	Washer	970033
5	305 9930	16	Federring	Spring ring	C 18,5 DIN74361
6	311 7650	2	Splint	Peg	6,3x56 DIN94-St Zn
7	319 9017	2	Kegelrollenlager	Bearing	30210 D90/50x21,75
8	319 9216	2	Kegelrollenlager	Bearing	32014X
9	323 0221	2	Scheibe	Washer	BPW 03.310.23.09.0
10	323 1323	2	Schutzkappe	Cap	D90,1
11	323 1680	2	Dichtring	Seal ring	05.120.26.08.0
12	323 1681	2	Stoßring	Thrust washer	03.370.05.14.0
13	450 6908	2	Radnabe	Wheel hub	8/220/275 D90

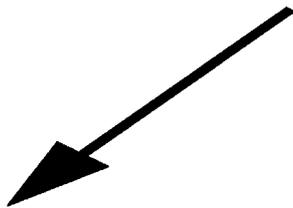
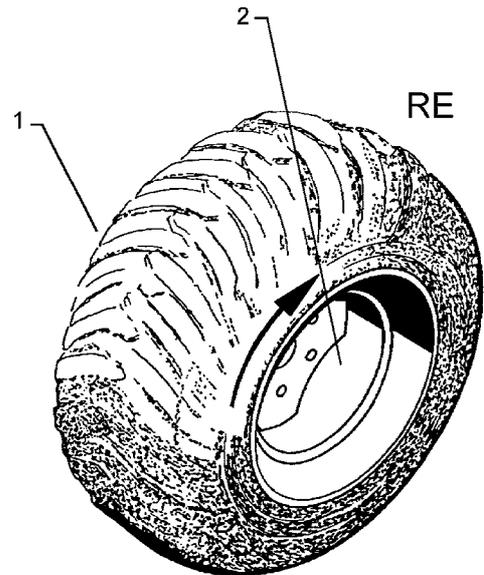
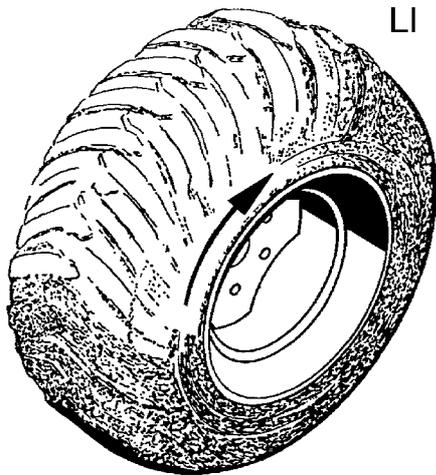

11.04

Pos.	Art.-Nr.	Stk.	Artikeltext / Description	Abmessung
1	357 7072	1	Reifen	Tyre
2	357 8871	1	Felge	Felge
				550/60-22,5 T-404 12PR
				16,00x22,5 8/221/275 ET+70

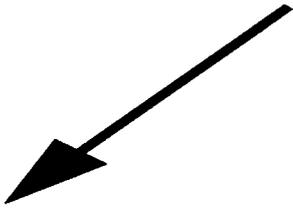
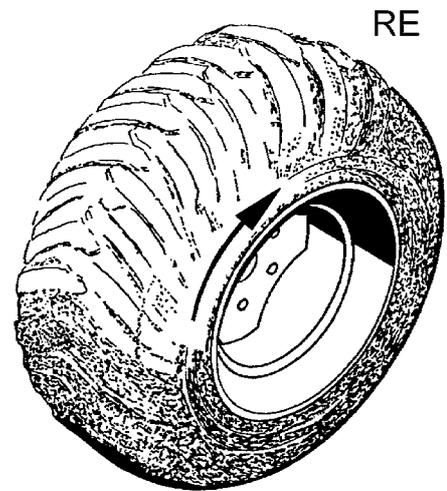
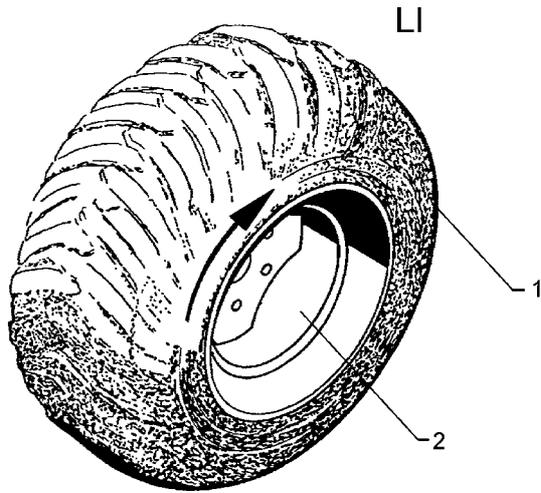

11.04

Pos.	Art.-Nr.	Stk.	Artikeltext / Description	Abmessung	
1	357 7072	1	Reifen	Tyre	
2	357 8871	1	Felge	Felge	
					550/60-22,5 T-404 12PR 16,00x22,5 8/221/275 ET+70

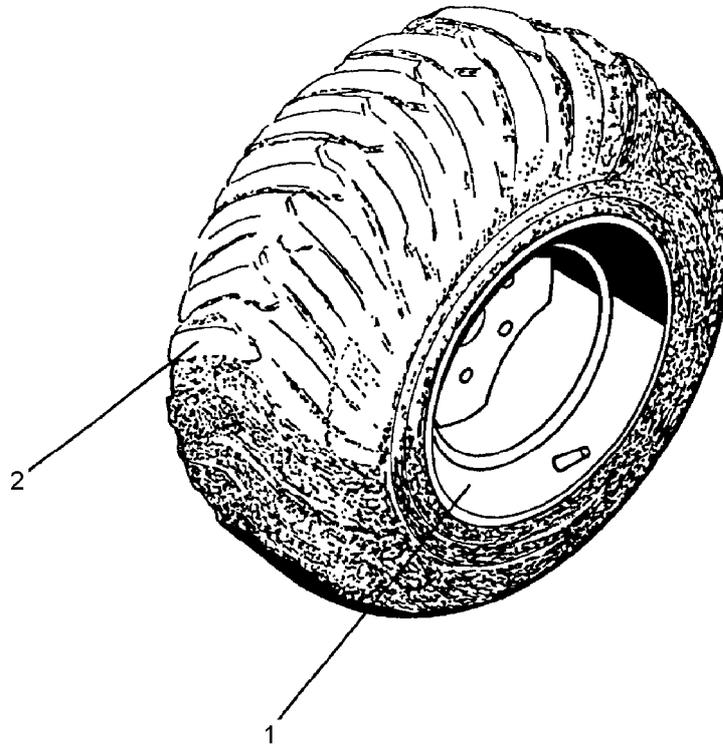

11.04

Pos.	Art.-Nr.	Stk.	Artikeltext / Description		Abmessung
1	357 7063	1	Felge	Felge	11x18 8/221/275 ET-35
2	357 8866	1	Reifen	Tyre	12.5/80-18 10PR AW

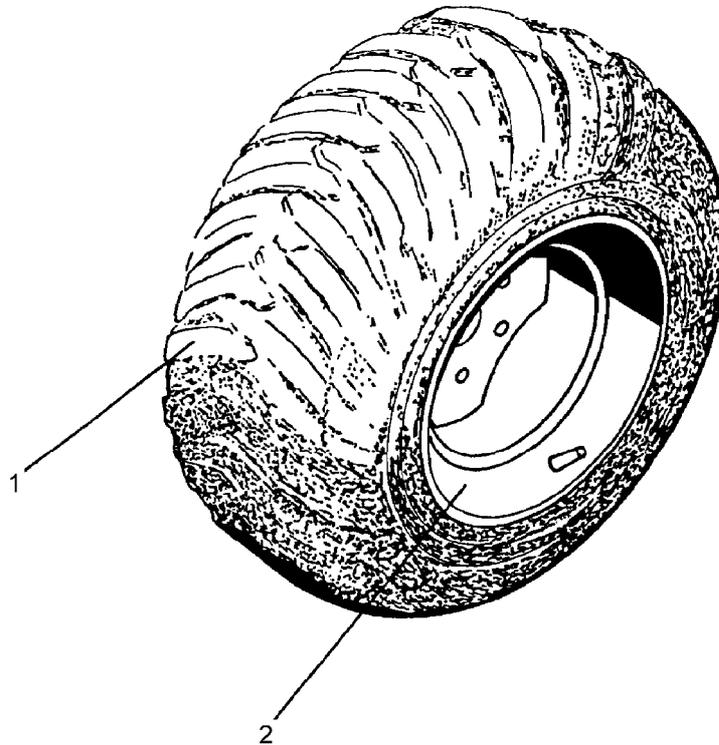

11.04

Pos.	Art.-Nr.	Stk.	Artikeltext / Description		Abmessung
1	357 7074	1	Reifen	Tyre	700/50-22,5 I-331 Alliance
2	357 8875	1	Felge	Felge	24,00x22,5 8/221/275 ET 0

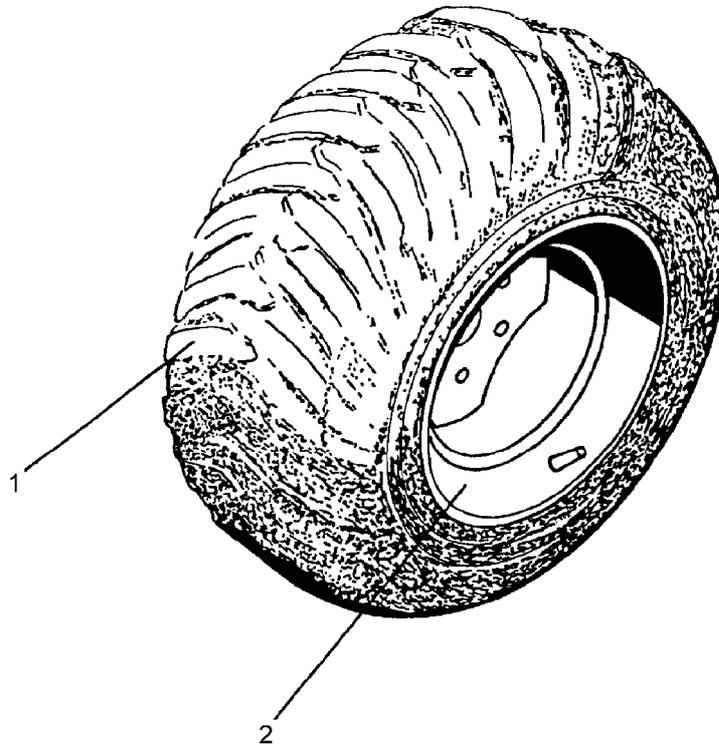

11.04

Pos.	Art.-Nr.	Stk.	Artikeltext / Description		Abmessung
1	357 7074	1	Reifen	Tyre	700/50-22,5 I-331 Alliance
2	357 8875	1	Felge	Felge	24,00x22,5 8/221/275 ET 0

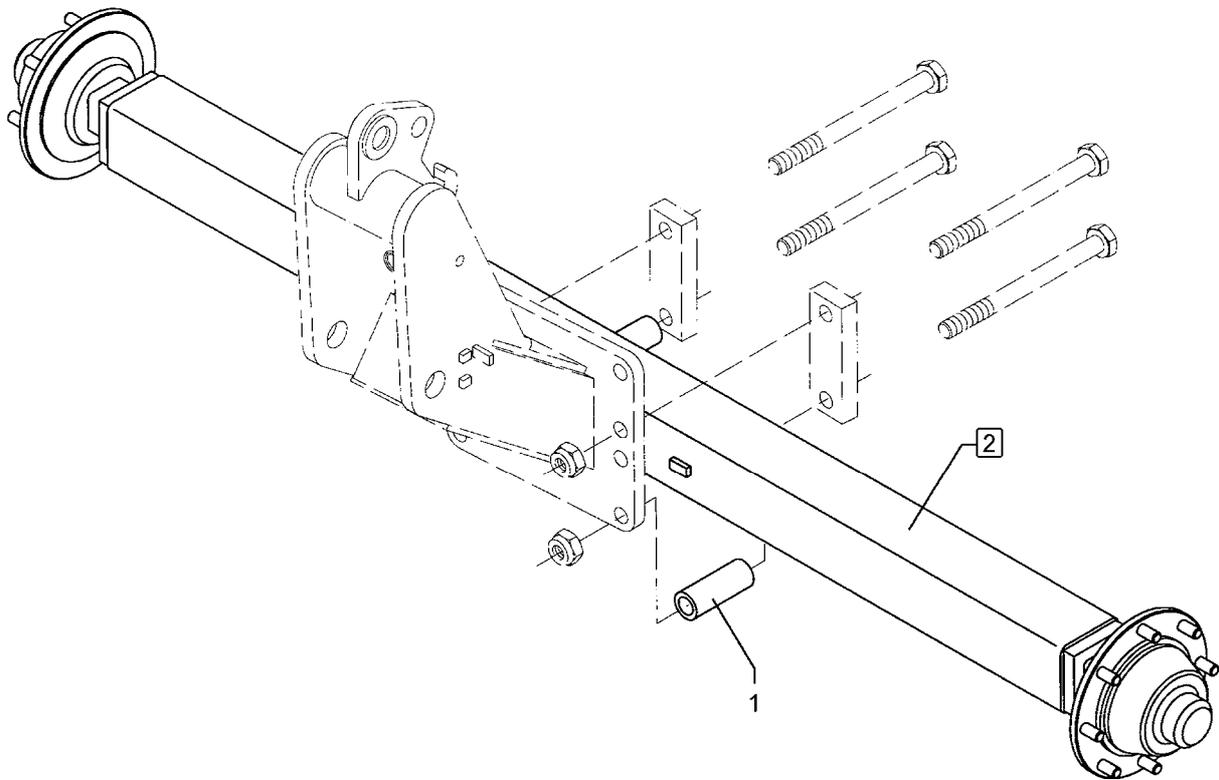

11.04

Pos.	Art.-Nr.	Stk.	Artikeltext / Description		Abmessung
1	317 6884	2	Röhrchen	Tube	51x8.8x138 +-1
2	550 8518	1	Laufachse	Running axle	140x140x2530 8/220/275

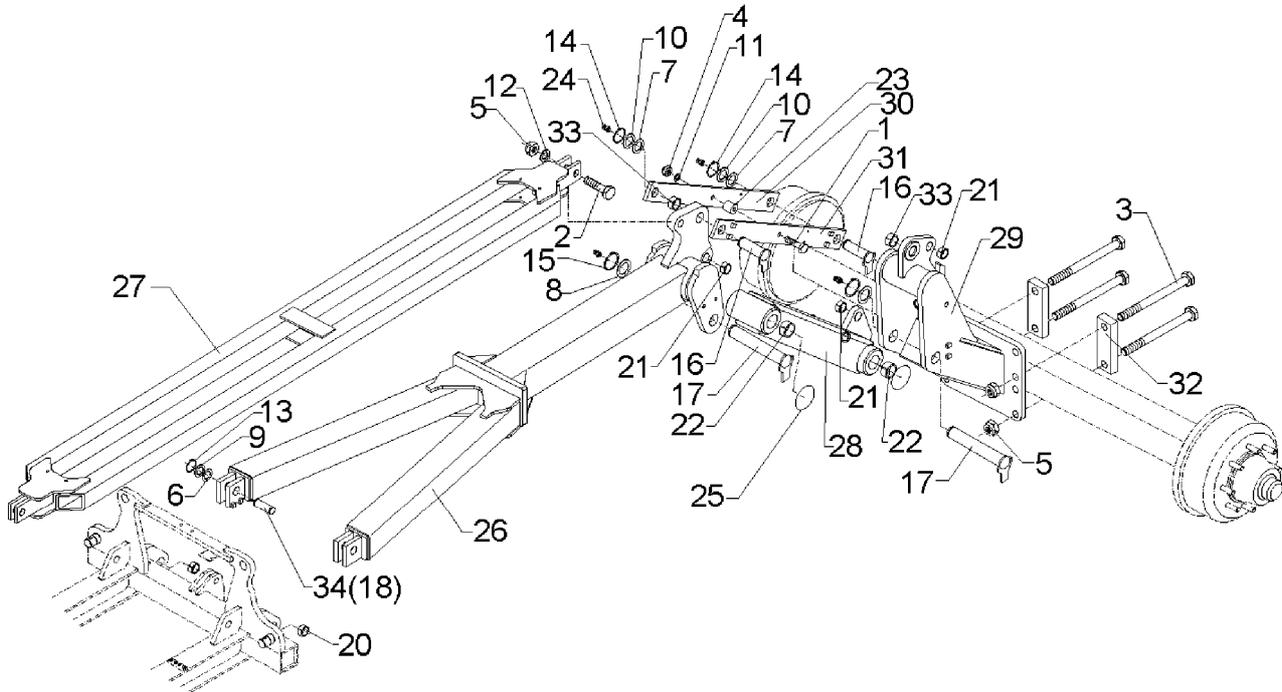

11.04

Pos.	Art.-Nr.	Stk.	Artikeltext / Description		Abmessung
1	301 3996	1	Sechskantschraube DIN931-A	Bolt	M16x100-8.8
2	301 4877	1	Sechskantschraube DIN931-A	Bolt	M30x120-8.8
3	301 4902	4	Sechskantschraube DIN931-A	Bolt	M30x240-8.8 Zn
4	303 0935	1	Sicherungsmutter	Selflocking nut	DIN985-NM16-8 Zn
5	303 0938	5	Sicherungsmutter	Selflocking nut	DIN985-NM30-8 Zn
6	305 2072	2	Paßscheibe	Shim	35x45x1,0 DIN988
7	305 2095	2	Paßscheibe	Shim	40x50x1,0 DIN988
8	305 2150	2	Paßscheibe	Shim	50x62x1,0 DIN988
9	305 2247	2	Stützscheibe	Supporting washer	S 35x45x2,5 DIN988
10	305 2250	2	Stützscheibe	Supporting washer	S 40x50x2,5 DIN988
11	305 6181	1	Scheibe	Washer	17 DIN7349
12	305 6326	2	Scheibe	Washer	60x31x6
13	305 8873	4	Sicherungsring	Securing ring	35x2,5 DIN471
14	305 8875	2	Sicherungsring	Securing ring	40x2,5 DIN471
15	305 8877	2	Sicherungsring	Securing ring	50x3 DIN471
16	313 4045	2	Bolzen mit Verdrehsicherung	Pin with stop	FN D40x80/99
17	313 5033	2	Bolzen mit Verdrehsicherung	Pin with stop	FN D50x254/279
18	313 8120	2	Bolzen mit Verdrehsicherung	Pin with stop	FN D35x74,35/95
20	317 3355	2	Einspannbuchse	Expansion bush	EG35/45x25
21	317 3417	2	Einspannbuchse mit Preßsitz	Expansion bush	EG30/38x25
22	317 3433	4	Einspannbuchse	Expansion bush	EG50+0,05+0,15/60x40
23	317 6889	1	Röhrchen	Tube	38x10x40
24	323 6348	4	Schmiernippel	Grease nipple	AM10x1 DIN71412
25	375 1295	4	O-Ring	O-ring	80x4-80Shore Viton83
26	450 8534	1	Ausleger	Outrigger	Smaragd 9/KA [B] 2355
27	450 8535	1	Lenker	Link	80x80x3234 Smaragd 9 KA-B

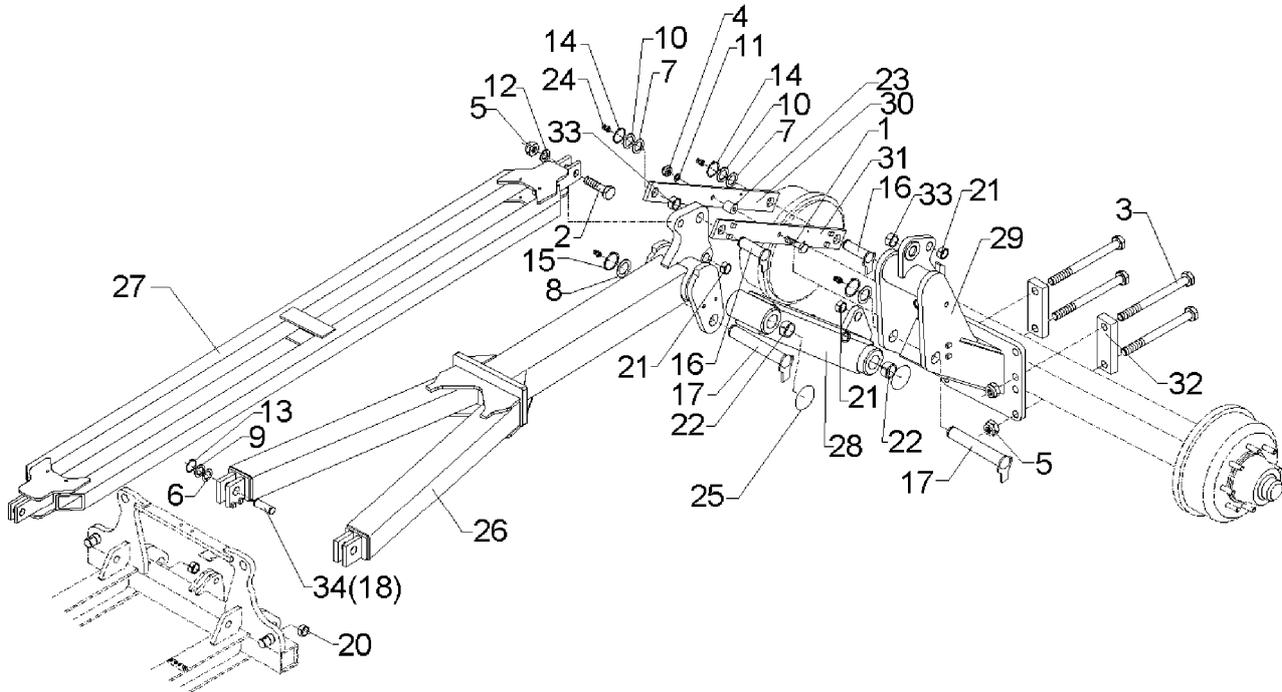

11.04

Pos.	Art.-Nr.	Stk.	Artikeltext / Description	Abmessung	
28	450 8538	1	Lenker	Link	140x140x780 D50x200
29	450 8539	1	Ausleger Sm 9/KA B	Boom	D50x200
30	450 8540	1	Lenker	Link	80x15x860 2xD40 1xD16,25
31	450 8541	1	Lenker	Link	80x15x860 2xD40 1xD16,25
32	459 1179	2	Brücke	Clamp plate	80x35x240 1x180-D31
33	317 2012	2	Einspannbuchse mit Preßsitz	Expansion bush	EG40/44x40
34	313 7785	2	Bolzen	Pin	NN D35x95 Zn

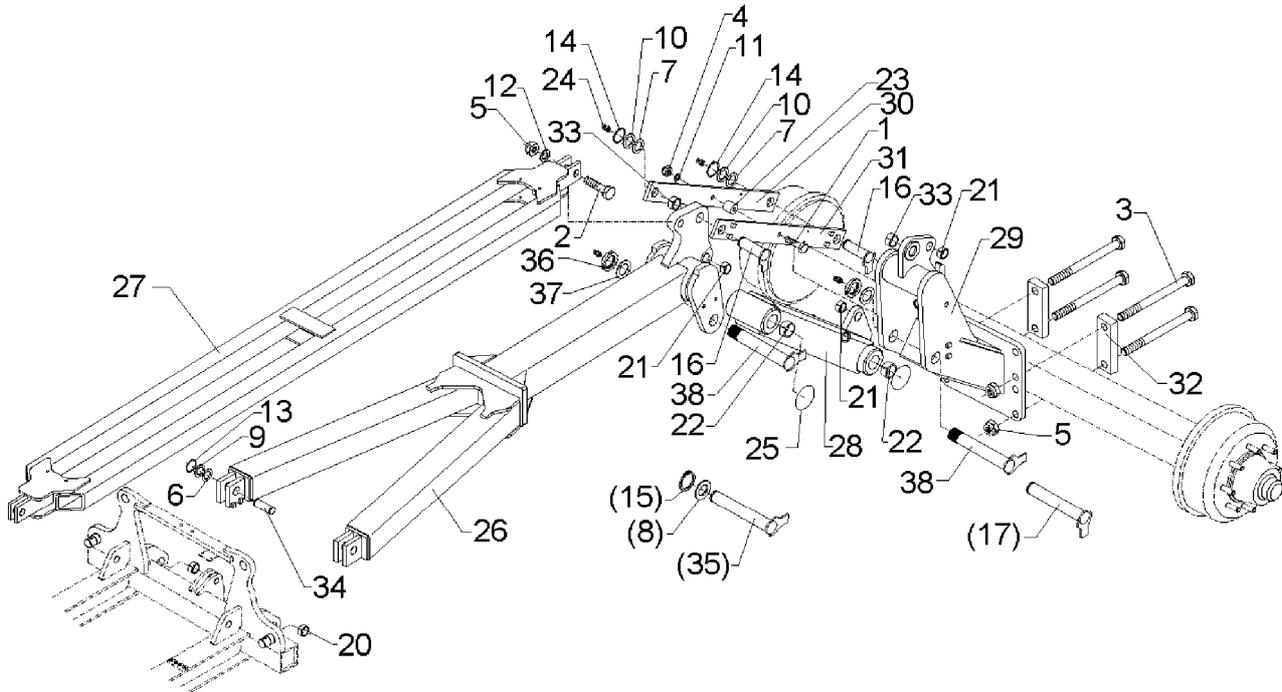

11.04

Pos.	Art.-Nr.	Stk.	Artikeltext / Description		Abmessung
1	301 3996	1	Sechskantschraube DIN931-A	Bolt	M16x100-8.8
2	301 4877	1	Sechskantschraube DIN931-A	Bolt	M30x120-8.8
3	301 4902	4	Sechskantschraube DIN931-A	Bolt	M30x240-8.8 Zn
4	303 0935	1	Sicherungsmutter	Selflocking nut	DIN985-NM16-8 Zn
5	303 0938	5	Sicherungsmutter	Selflocking nut	DIN985-NM30-8 Zn
6	305 2072	2	Paßscheibe	Shim	35x45x1,0 DIN988
7	305 2095	2	Paßscheibe	Shim	40x50x1,0 DIN988
8	305 2150	2	Paßscheibe	Shim	50x62x1,0 DIN988
9	305 2247	2	Stützscheibe	Supporting washer	S 35x45x2,5 DIN988
10	305 2250	2	Stützscheibe	Supporting washer	S 40x50x2,5 DIN988
11	305 6181	1	Scheibe	Washer	17 DIN7349
12	305 6326	2	Scheibe	Washer	60x31x6
13	305 8873	4	Sicherungsring	Securing ring	35x2,5 DIN471
14	305 8875	2	Sicherungsring	Securing ring	40x2,5 DIN471
15	305 8877	2	Sicherungsring	Securing ring	50x3 DIN471
16	313 4045	2	Bolzen mit Verdrehsicherung	Pin with stop	FN D40x80/99
17	313 5033	1	Bolzen mit Verdrehsicherung	Pin with stop	FN D50x254/279
20	317 3355	2	Einspannbuchse	Expansion bush	EG35/45x25
21	317 3417	2	Einspannbuchse mit Preßsitz	Expansion bush	EG30/38x25
22	317 3433	4	Einspannbuchse	Expansion bush	EG50+0,05+0,15/60x40
23	317 6889	1	Röhrchen	Tube	38x10x40
24	323 6348	4	Schmiernippel	Grease nipple	AM10x1 DIN71412
25	375 1295	4	O-Ring	O-ring	80x4-80Shore Viton83
26	450 8537	1	Ausleger	Outrigger	Smaragd 9/KA [B] 2355
27	450 8535	1	Lenker	Link	80x80x3234 Smaragd 9 KA-B
28	450 8538	1	Lenker	Link	140x140x780 D50x200

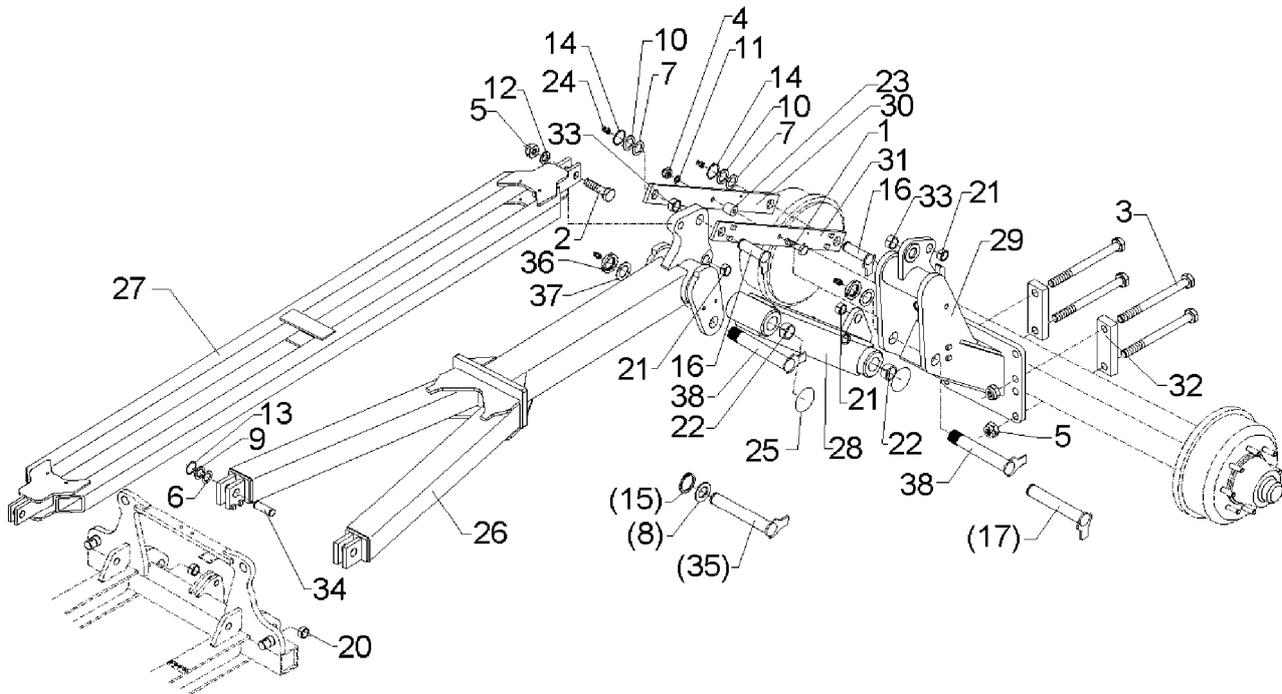

11.04

Pos.	Art.-Nr.	Stk.	Artikeltext / Description	Abmessung	
29	450 8539	1	Ausleger Sm 9/KA B	Boom	D50x200
30	450 8540	1	Lenker	Link	80x15x860 2xD40 1xD16,25
31	450 8541	1	Lenker	Link	80x15x860 2xD40 1xD16,25
32	459 1179	2	Brücke	Clamp plate	80x35x240 1x180-D31
33	317 2012	2	Einspannbuchse mit Preßsitz	Expansion bush	EG40/44x40
34	313 7785	2	Bolzen	Pin	NN D35x95 Zn
35	313 5031	1	Bolzen mit Verdrehsicherung	Pin with stop	FN D50x265/290-S
36	303 0351	2	Nutmutter	Grooved nut	M50x1,5 SI
37	305 2255	2	Stützscheibe	Supporting washer	S 50x62x3 DIN988
38	313 5043	2	Bolzen mit Verdrehsicherung	Pin with stop	FG D50x290-M50X1,5-M10x1

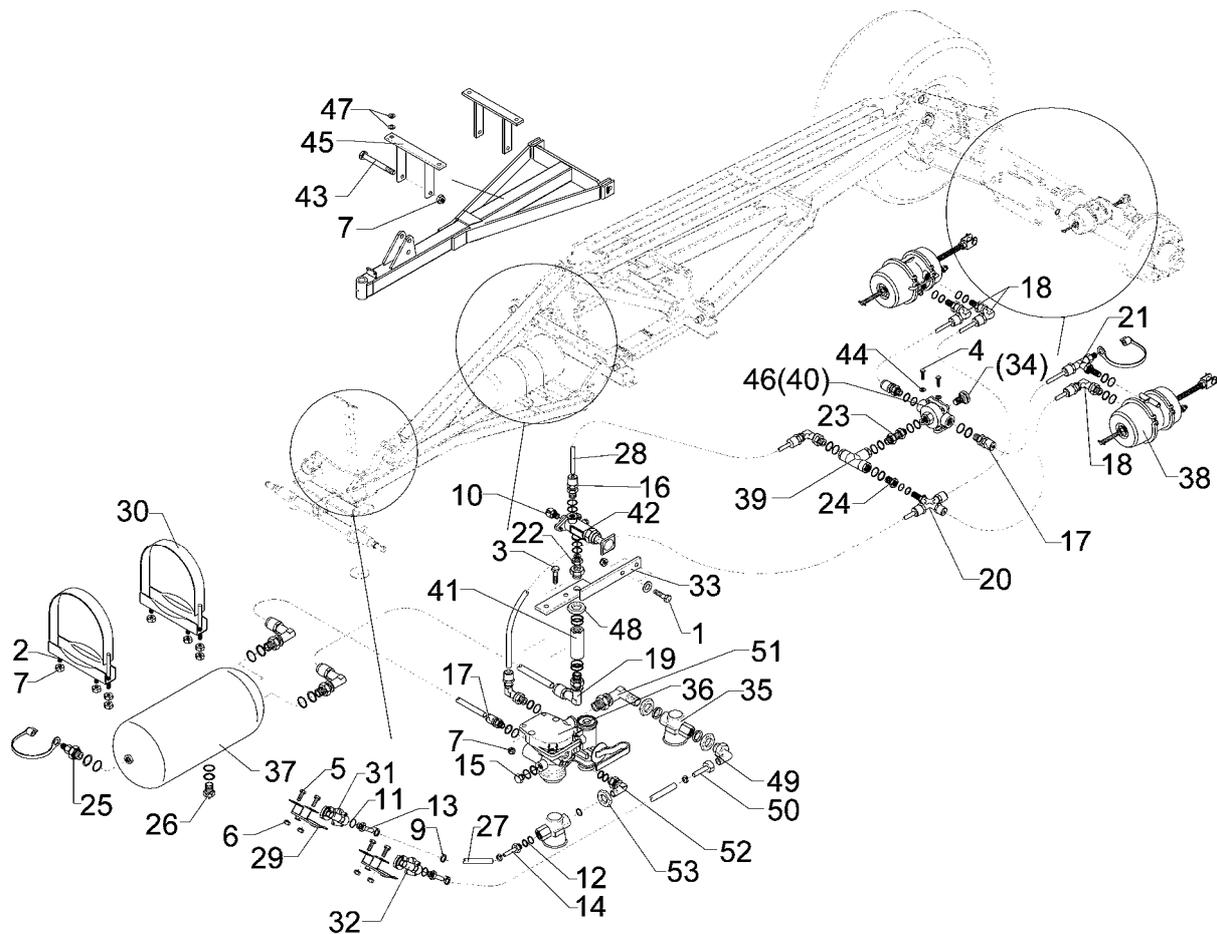

11.04

Pos.	Art.-Nr.	Stk.	Artikeltext / Description	Abmessung	
1	301 5424	2	Sechskantschraube DIN931-A	Bolt	M10x45-8.8 Zn
2	301 5004	6	Sechskantschraube DIN933	Screw	M10x30-8.8 Zn
3	301 5009	2	Sechskantschraube DIN933	Screw	M10x40-8.8 Zn
4	301 7260	2	Sechskantschraube DIN933	Screw	M8x16-8.8 Zn
5	301 7280	4	Sechskantschraube DIN933	Screw	M8x25-8.8 Zn
6	303 0932	4	Sicherungsmutter	Selflocking nut	DIN985-NM8-8 Zn
7	303 0933	10	Sicherungsmutter	Selflocking nut	DIN985-NM10-8 Zn
8	305 8694	4	Scheibe	Washer	A8,4 DIN125-St Zn
9	325 1145	4	Schlauchschelle	Hose clip	12/20
10	375 2190	1	Be- und Entlüftungsschraube	Vent plug	M16x1,5
11	377 1180	2	Druckring mit O-Ring	Thrust ring with O-ring	DR/R16x21-RU/14x2,5
12	377 1181	5	Druckring mit O-Ring	Thrust ring with O-ring	DR/R22x27-RU/20,3x2,4
13	377 1301	2	Schlauchstutzen	Hose nipple	ES/BM 16x1,5-11
14	377 1302	1	Schlauchstutzen	Hose nipple	ES/B15-11 M22x1,5
15	377 1350	1	Verschlussschraube	Plug	VS/BM 22x1,5
16	377 1400	3	Gerade Einschraubsteckverb.	Push-in connection	M16x1,5 12x1,5
17	377 1401	1	Gerade Einschraubsteckverb.	Push-in connection	M22x1,5 12x1,5
18	377 1409	3	Winkel Einschraubsteckverb.	Push-in connection	M16x1,5 12x1,5
19	377 1410	5	Winkel Einschraubsteckverb.	Push-in connection	M22x1,5 12x1,5
20	377 1440	1	Kreuz Einschraubsteckverbind.	Push-in connection	M16x1,5 12x1,5
21	377 1450	1	Winkel Einschraubsteckverb.	Push-in connection	mit Prüfanschl. M16x1,5 12x1,5
22	377 1460	1	Gerade Einschraubstutzen	Screwed socket	M16x1,5 M22x1,5
23	377 1461	1	Gerade Einschraubstutzen	Screwed socket	M22x1,5 M22x1,5
24	377 1482	1	Reduzierstück	Reducing fitting	M22x1,5 M16x1,5
25	377 1341	1	Prüfanschluß	Test coupling	318 040 001 M22x1,5
26	377 1380	1	Entwässerungsventil	Dewatering valve	M22x1,5 315 019 001

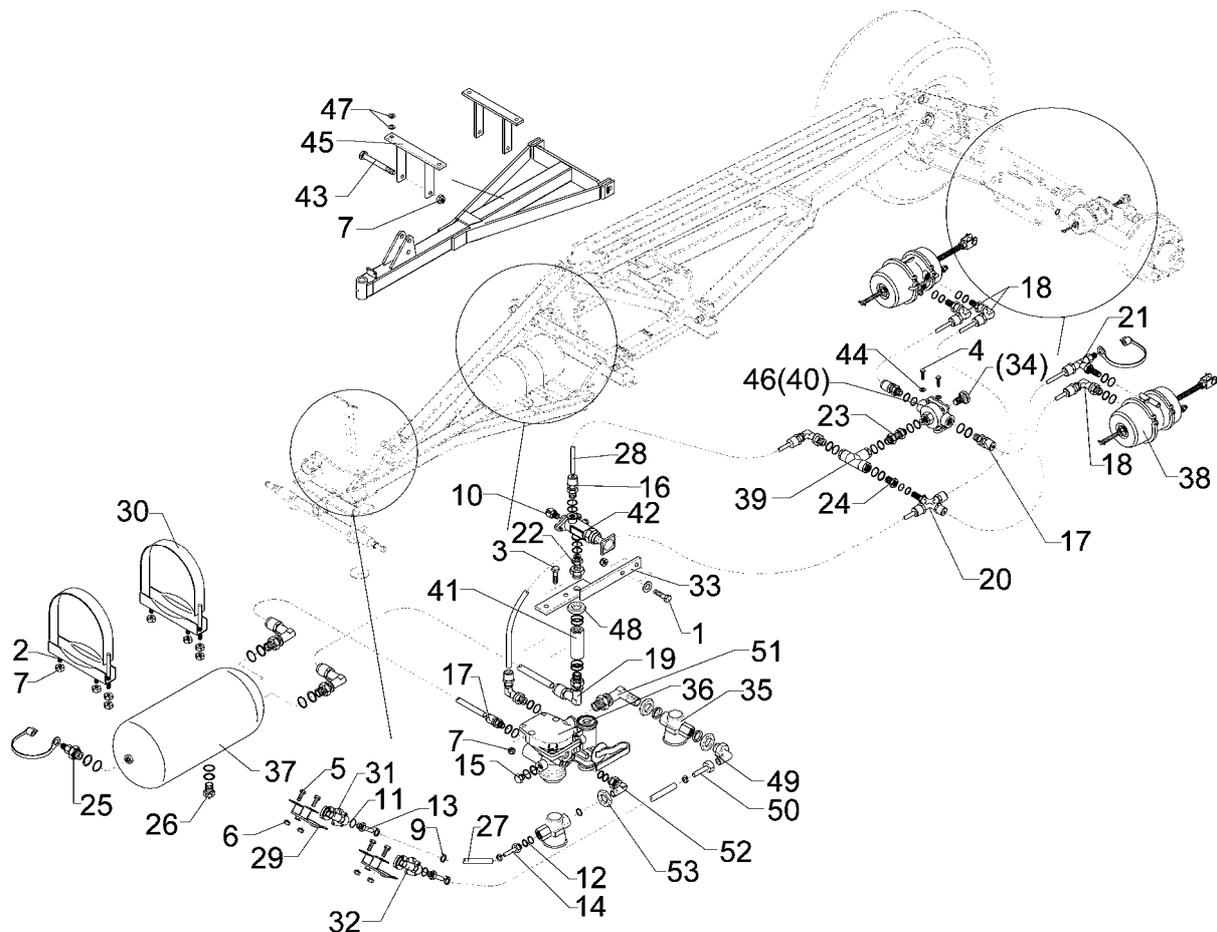

11.04

Pos.	Art.-Nr.	Stk.	Artikeltext / Description		Abmessung
27	377 2025	2	Bremsschlauch	Brake hose	11,5x3,5-4x4200
28	377 2070	15	Kunststoffrohr Meter-Ware	Synthetic tube	12x1,5 DIN 74324
29	377 2520	2	Leerkupplung	Hose clamp	334 028 001
30	377 2532	2	Spannband	Strap	D310 030 200 409
31	377 2540	1	Kupplungskopf Vorrat rot	Hose coupling	M16x1,5 334 055 201
32	377 2541	1	Kupplungskopf Bremse gelb	Hose coupling	M16x1,5 334 054 201
33	477 1125	1	Halter	Holder	30x8x330
34	577 2570	1	EntlüftungsfILTER	Venting filter	M22x1,5 031 000 909
35	577 2580	2	Rohrleitungsfilter	Filter	M22x1,5 310 005 011
36	577 2591	1	Anhängerbremssventil	Trailer brake valve	350 027 002
37	577 2622	1	Druckluftbehälter	Compressed-air container	D310x620 030 362 009D
38	577 2641	2	Membranzylinder	Membrane-cylinder	24/30 M16x1,5 346 181 001
39	577 2660	1	Zweiwegeventil	2-port control valve	M22x1,5 333 004 001
40	577 2670	1	Schnellöseventil	Quick release valve	M22x1,5 356 012 031
41	577 2680	1	Rückschlagventil	Nonreturn valve	M22x1,5 314 001 021
42	577 2690	1	Parkventil	Parking valve	M16x1,5
43	301 5438	2	Sechskantschraube DIN931-A	Bolt	M10x150-8.8 Zn
44	305 9898	2	Federring	Spring ring	8 A DIN127 Zn
45	477 1126	2	Halter	Holder	30x8x230/111
46	577 2671	1	Schnellöseventil	Quick release valve	M16x1,5 356 023 011
47	305 8696	8	Scheibe	Washer	A10,5 DIN125-St Zn
48	375 5698	1	Sechskantmutter	Nut	M16x1,5 SW22 Zn
49	377 1260	1	Winkel-Einschraubverschraubung	Angle union	15/1-26/12 M22x1,5
50	377 1300	1	Schlauchstutzen	Hose nipple	15-70/12-11
51	377 1472	2	Winkel Einschraubstutzen	Screwed socket	M22x1,5 M22x1,5
52	377 1473	1	Winkel Einschraubstutzen	Screwed socket	M22x1,5 M16x1,5

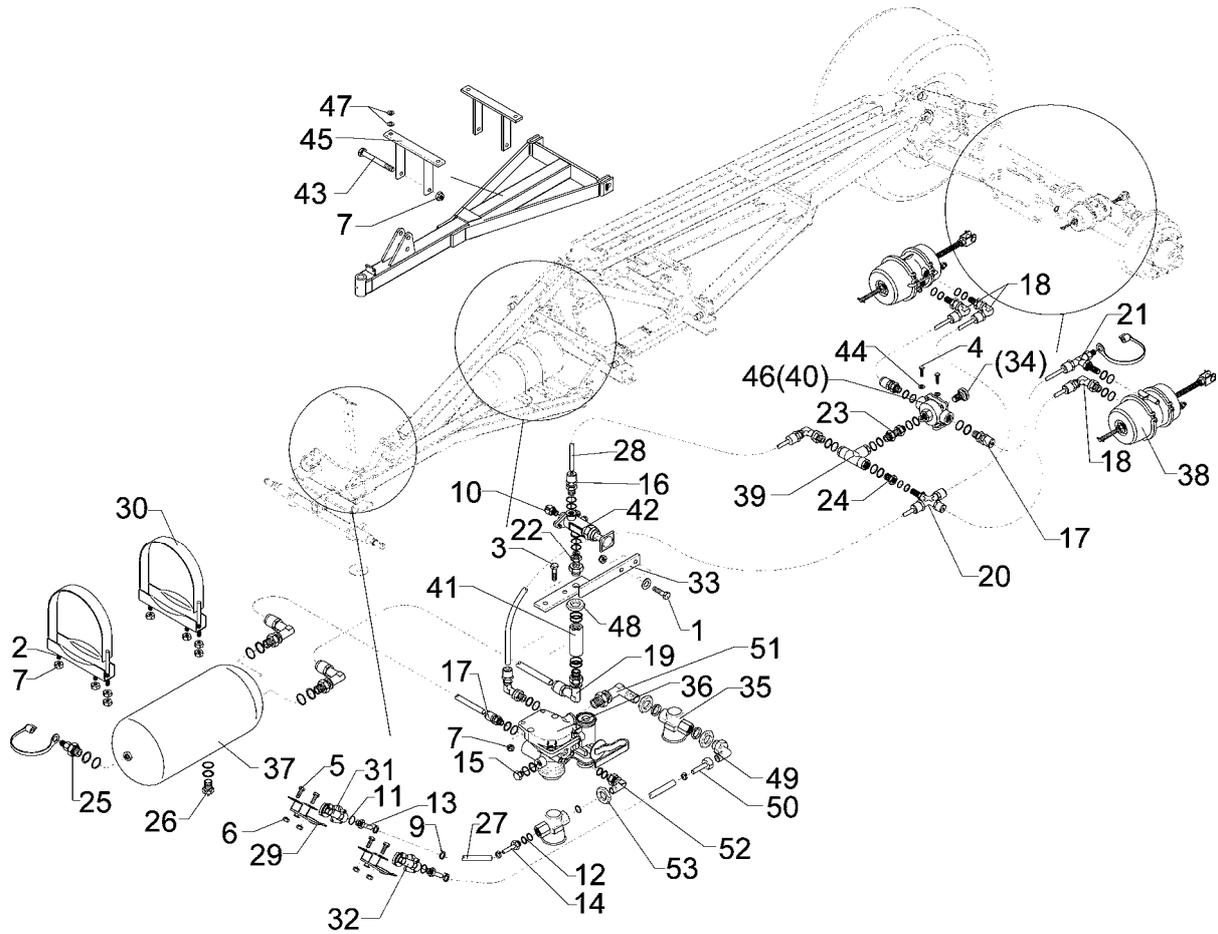

11.04

Pos.	Art.-Nr.	Stk.	Artikeltext / Description	Abmessung	
53	375 5710	1	Sechskantmutter	Nut	M22x1,5 SW27x7

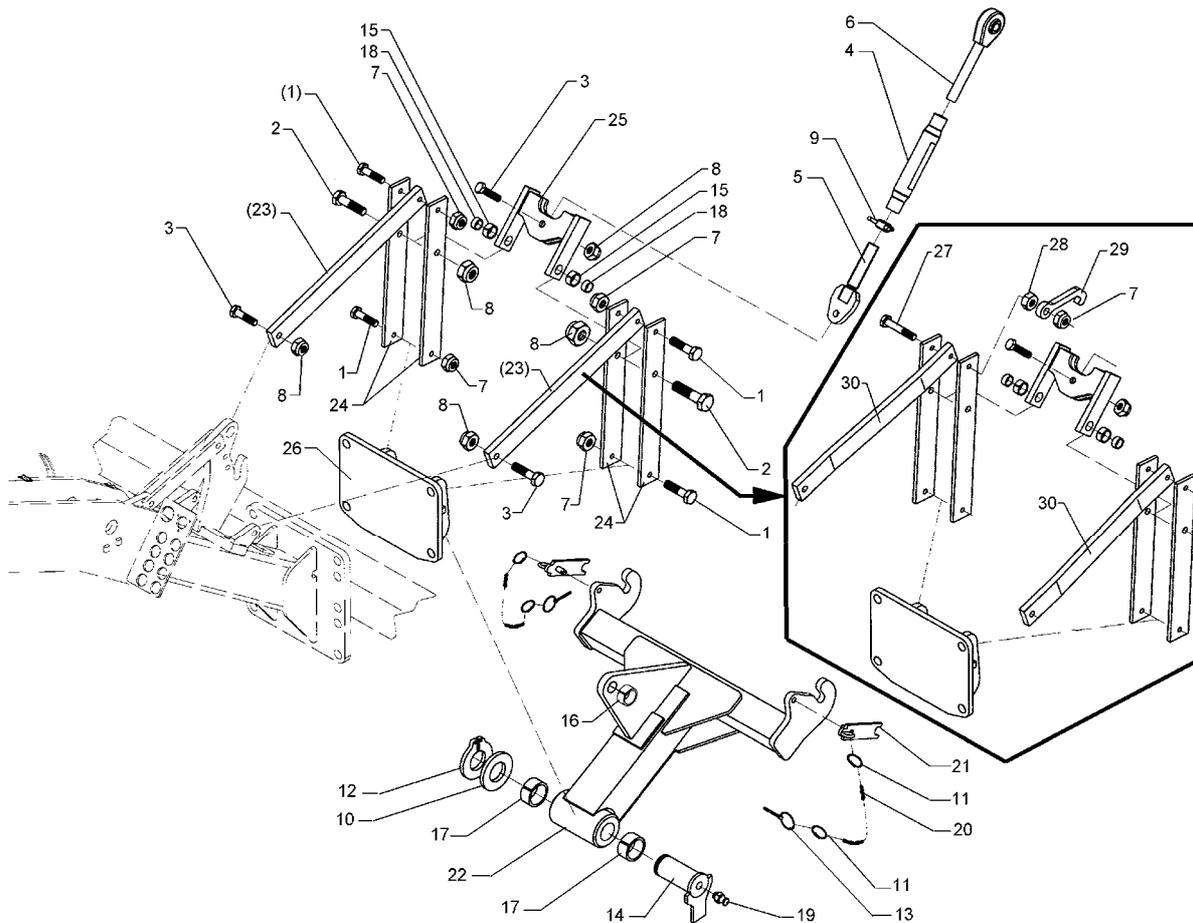

11.04

Pos.	Art.-Nr.	Stk.	Artikeltext / Description		Abmessung
1	301 3867	3	Sechskantschraube DIN931-A	Bolt	M16x65-8.8
2	301 4331	2	Sechskantschraube DIN931-A	Bolt	M20x75-8.8
3	301 5390	3	Sechskantschraube spz.	Bolt	M20x65-12.9
4	302 8937	1	Spannschloßmutter	Threaded sleeve	M36x3x330 SW36
5	302 9019	1	Gelenkstück	Joint	M36x3x190 D20
6	302 9033	1	Gelenkauge	Joint	KAT2 M36x3x270 LI
7	303 0935	4	Sicherungsmutter	Selflocking nut	DIN985-NM16-8 Zn
8	303 0936	5	Sicherungsmutter	Selflocking nut	DIN985-NM20-8 Zn
9	303 3110	1	Schlagmutter	Impact nut	M36x3 65-5
10	305 2150	1	Paßscheibe	Shim	50x62x1,0 DIN988
11	305 8545	4	Sicherungsring	Securing ring	3x30-35x1,25 Zn
12	305 8877	1	Sicherungsring	Securing ring	50x3 DIN471
13	311 9565	2	Klappstift	Securing pin	4,5mm
14	313 5037	1	Bolzen mit Verdrehsicherung	Pin with stop	FN D50x243/268
15	317 3352	2	Einspannbuchse mit Preßsitz	Expansion bush	EG28/32x20
16	317 3417	1	Einspannbuchse mit Preßsitz	Expansion bush	EG30/38x25
17	317 3433	2	Einspannbuchse	Expansion bush	EG50+0,05+0,15/60x40
18	317 6657	2	Buchse	Bush	D20/28x22
19	323 6348	1	Schmiernippel	Grease nipple	AM10x1 DIN71412
20	331 6130	2	Knotenkette	Chain	D2x150
21	461 8345	2	Riegel	Locking bar	KAT2
22	461 8510	1	Unterlenker	Lower link	D50x200 L2
23	461 8511	2	Lenker	Link	70x22x700 1xD16 1xD20
24	461 8512	4	Lenker	Link	80x12x595 2xD16 1xD20
25	461 8513	1	Lenker	Link	60x20x208 2xD32 1xD20
26	461 8514	1	Konsole	Bracket	430x260x20 D50x200

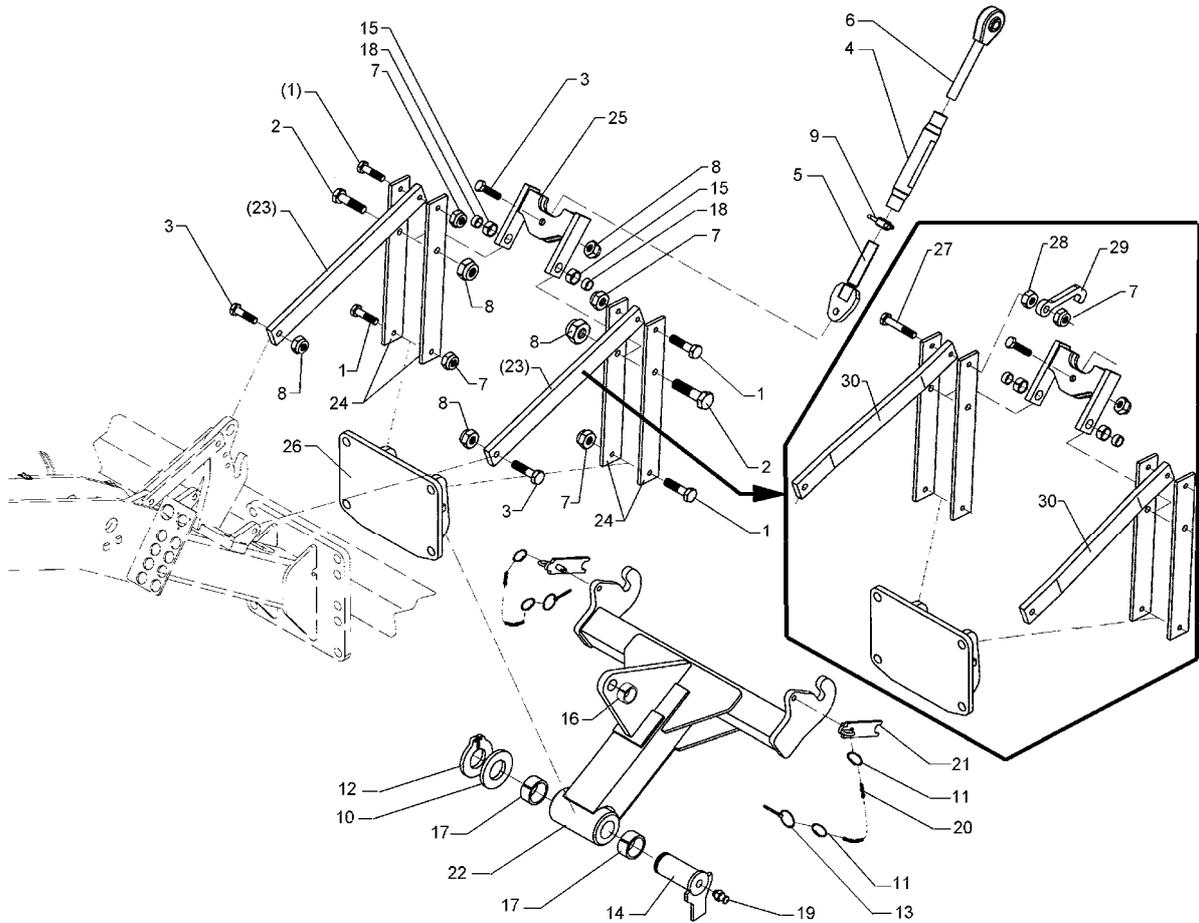

11.04

Pos.	Art.-Nr.	Stk.	Artikeltext / Description	Abmessung	
27	301 5085	1	Sechskantschraube DIN933	Screw	M16x100-8.8
28	303 0976	1	Sechskantmutter	Nut	M16 DIN934-8
29	461 8515	1	Haken	Hook	144x56x14 1xD16,5
30	461 8516	2	Lenker, gebogen	Link	70x22x700 1xD16 1xD20

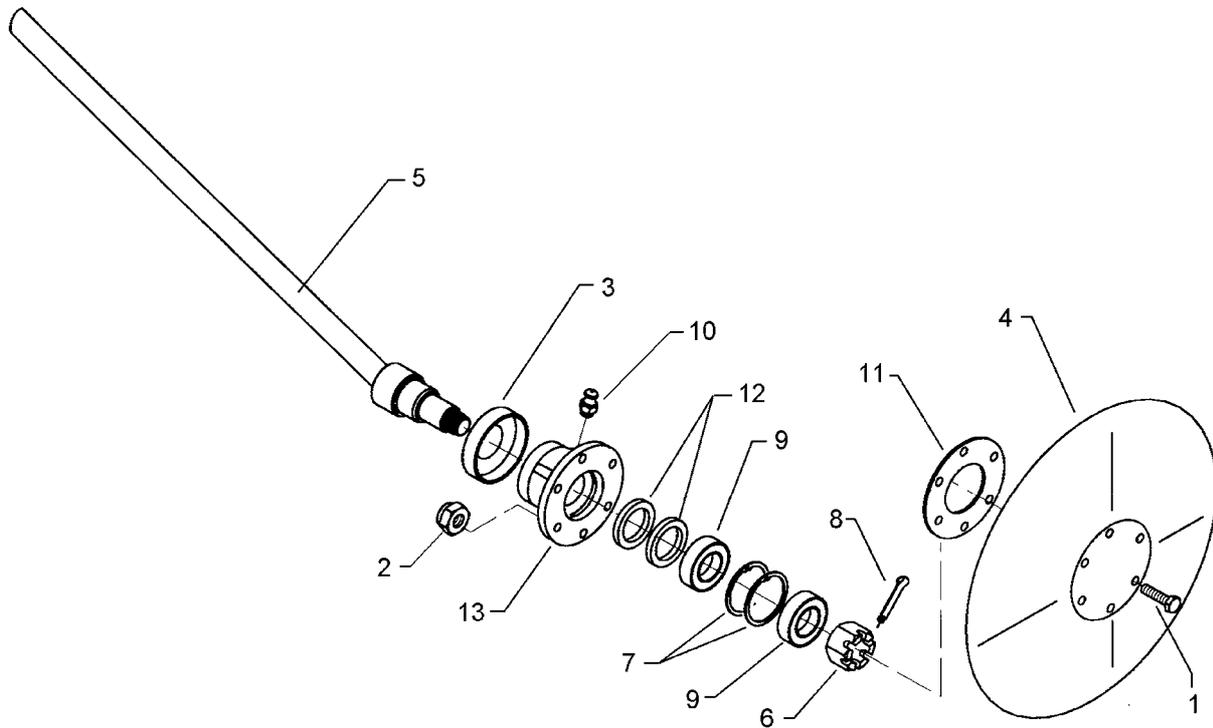

11.04

Pos.	Art.-Nr.	Stk.	Artikeltext / Description		Abmessung
1	301 3224	6	Sechskantschraube DIN933	Screw	M10x30-8.8
2	303 0933	6	Sicherungsmutter	Selflocking nut	DIN985-NM10-8 Zn
3	323 0410	1	Schutzkappe	Cap	D81/77/40x18x2
4	349 0460	1	Hohlscheibe	Hollow disc	D380/100
5	482 1248	1	Achse	Axle	D30x595
6	303 0193	1	Kronenmutter	Castle nut	DIN937-M24x1,5-22H
7	305 8924	2	Sicherungsring	Securing ring	62x2 DIN472
8	311 7613	1	Splint	Peg	3,2x40 DIN94-St Zn
9	319 9116	2	Kegelrollenlager	Bearing	30206.
10	323 6345	1	Schmiernippel	Grease nipple	LAM 6 DIN71412
11	323 7641	1	Dichtung	Seal	D120/65x1,6
12	323 8032	2	Wellendichtring	Oil seal	40x55x7 BA
13	447 8882	1	Nabe	Hub	668 A

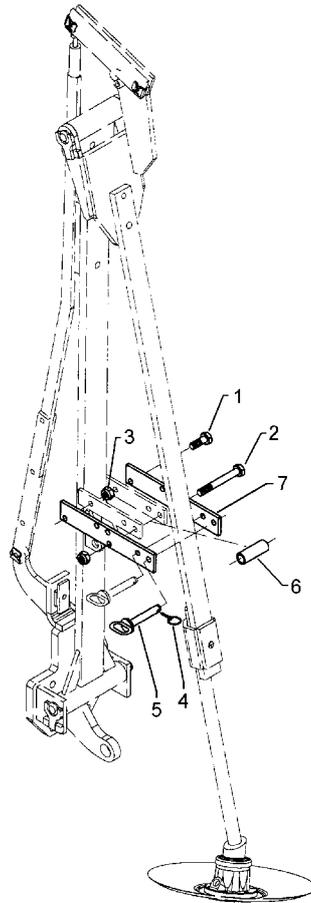

11.04

Pos.	Art.-Nr.	Stk.	Artikeltext / Description	Abmessung	
1	301 3324	2	Sechskantschraube DIN933	Screw	M12x30-8.8 Zn
2	301 3498	1	Sechskantschraube DIN931-A	Bolt	M12x120-8.8 Zn
3	303 0934	3	Sicherungsmutter	Selflocking nut	DIN985-NM12-8 Zn
4	311 9565	1	Klappstift	Securing pin	4,5mm
5	313 8137	1	Bolzen mit Griff	Pin with grip	GB D12x103,5/1185
6	317 6844	1	Röhrchen	Tube	26,9x5x70
7	482 1293	2	Flach	Flat steel	50x6x295 6xD13

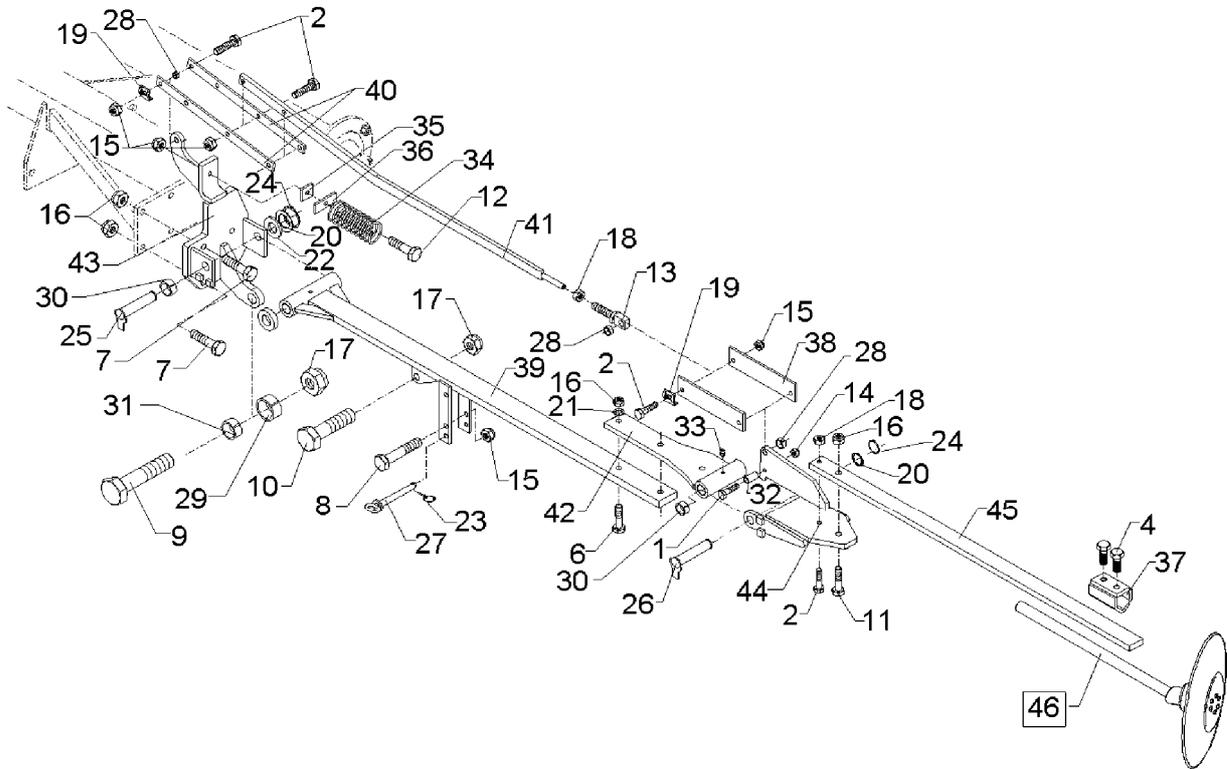

11.04

Pos.	Art.-Nr.	Stk.	Artikeltext / Description		Abmessung
1	301 3248	1	Sechskantschraube DIN931-A	Bolt	M10x55-8.8 Zn
2	301 3366	6	Sechskantschraube spz.	Bolt	M12x45-8.8
4	301 3667	2	Sechskantschraube spz.	Bolt	M16x1,5x35-10.9-Zn DIN961-A
6	301 3779	2	Sechskantschraube spz.	Bolt	M16x60-10.9
7	301 3904	4	Sechskantschraube DIN931-A	Bolt	M16x75-8.8 Zn
8	301 3462	1	Sechskantschraube DIN931-A	Bolt	M12x100-8.8 Zn
9	301 4287	1	Sechskantschraube DIN931-A	Bolt	M20x65-8.8 Zn
10	301 4350	1	Sechskantschraube DIN931-A	Bolt	M20x80-8.8 Zn
11	301 5389	1	Sechskantschraube spz.	Bolt	M16x50-8.8
12	301 5449	1	Sechskantschraube DIN931-A	Bolt	M12x45-8.8 Zn
13	302 8946	1	Gewindeauge	Boss	M12x70-D16
14	303 0933	1	Sicherungsmutter	Selflocking nut	DIN985-NM10-8 Zn
15	303 0934	7	Sicherungsmutter	Selflocking nut	DIN985-NM12-8 Zn
16	303 0935	11	Sicherungsmutter	Selflocking nut	DIN985-NM16-8 Zn
17	303 0936	2	Sicherungsmutter	Selflocking nut	DIN985-NM20-8 Zn
18	303 0972	2	Sechskantmutter	Nut	M12 DIN934-8
19	305 1402	3	Sicherungsblech	Locking plate	SW19-15 28x3 Zn
20	305 2230	3	Stützscheibe	Supporting washer	S 25x35x2,0 DIN988
21	305 6155	2	Scheibe	Washer	D30/17x6 St-37
22	305 6274	1	Scheibe	Washer	D50/25x8
23	311 9565	1	Klappstift	Securing pin	4,5mm
24	305 8861	2	Sicherungsring	Securing ring	25x2 DIN471 Zn
25	313 2527	1	Bolzen mit Verdrehsicherung	Pin with stop	FN D25x226/243
26	313 2535	1	Bolzen mit Verdrehsicherung	Pin with stop	FN D25/55x176/193
27	313 8137	1	Bolzen mit Griff	Pin with grip	GB D12x103,5/1185
28	317 3302	3	Einspannbuchse	Expansion bush	EG12/16x12-DIN1498

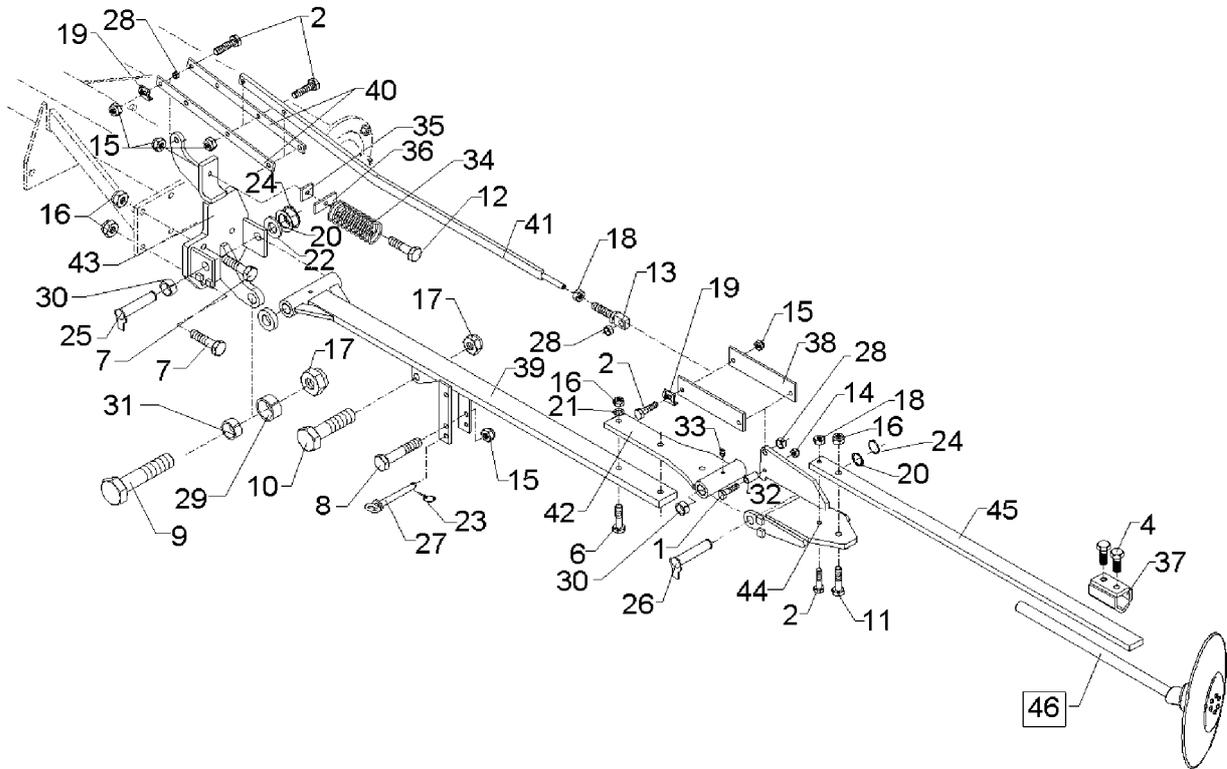

11.04

Pos.	Art.-Nr.	Stk.	Artikeltext / Description		Abmessung
29	317 3352	1	Einspannbuchse mit Preßsitz	Expansion bush	EG28/32x20
30	317 3413	4	Einspannbuchse nach DIN 1498	Expansion bush	EG25/32x20
31	317 6657	1	Buchse	Bush	D20/28x22
32	317 6791	2	Röhrchen	Tube	20/10x16,5
33	323 6349	2	Schmiernippel	Grease nipple	CM10x1 DIN71412-90°
34	329 8461	1	Druckfeder	Spring	10x69x145
35	459 4875	1	Scheibe	Washer	D12/40x40x6
36	459 4876	1	Lasche	Lashing	30x6x80 1xD12
37	482 1250	1	Klemme	Clamp	D30-50x15 100mm
38	482 1255	2	Brücke	Clamp plate	60x8x253 1x223-D12
39	482 1275	1	Schwenkarm	Swinging arm	D51/25x189-70x22x1360
40	482 1276	2	Flach	Flat steel	30x8x454 4xD12,25
41	482 1277	1	Steuerstange	Rod	30x12x1260 M12x80
42	482 1278	1	Schwenklager	Swivel bearing	D25x149-16x388
43	482 1279	1	Konsole	Bracket	D25x190 4xD16,5
44	482 1280	1	Konsole	Bracket	D25x150
45	482 1281	1	Flach	Flat steel	50x18x1244 1xD16,25/12,25
46	582 1248	1	Achse zum Spuranreißer	Axle for track marker	D30x595 668A

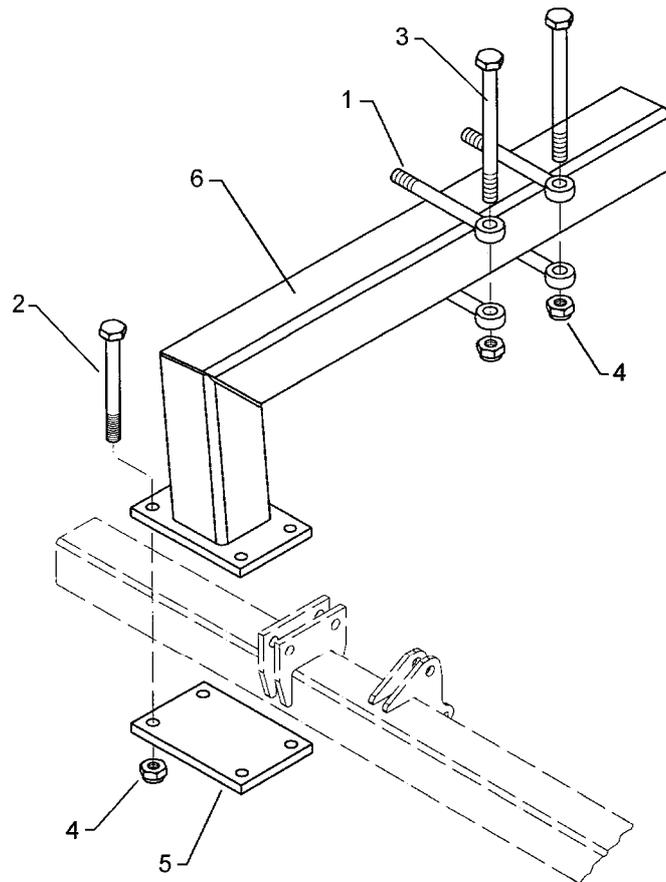

11.04

Pos.	Art.-Nr.	Stk.	Artikeltext / Description	Abmessung	
1	301 0860	4	Augenschraube DIN444	Eye bolt	BM16x150-8.8 D2=16,1 Zn
2	301 4057	4	Sechskantschraube DIN931-A	Bolt	M16x130-8.8 Zn
3	301 5410	2	Sechskantschraube DIN931-A	Bolt	M16x160-8.8 Zn
4	303 0935	8	Sicherungsmutter	Selflocking nut	DIN985-NM16-8 Zn
5	459 9351	1	Klemmplatte	Clamping plate	15x140x210 4xD17
6	482 1290	1	Konsole zum Spuranreißer	Bracket for track marker	Smaragd 9 KA 6M RE
7	301 4118	2	Sechskantschraube	Bolt	M16x1,5x162ls140xb19-10.9
8	303 1017	2	Sechskantmutter	Nut	M16x1,5 DIN934-10 Zn

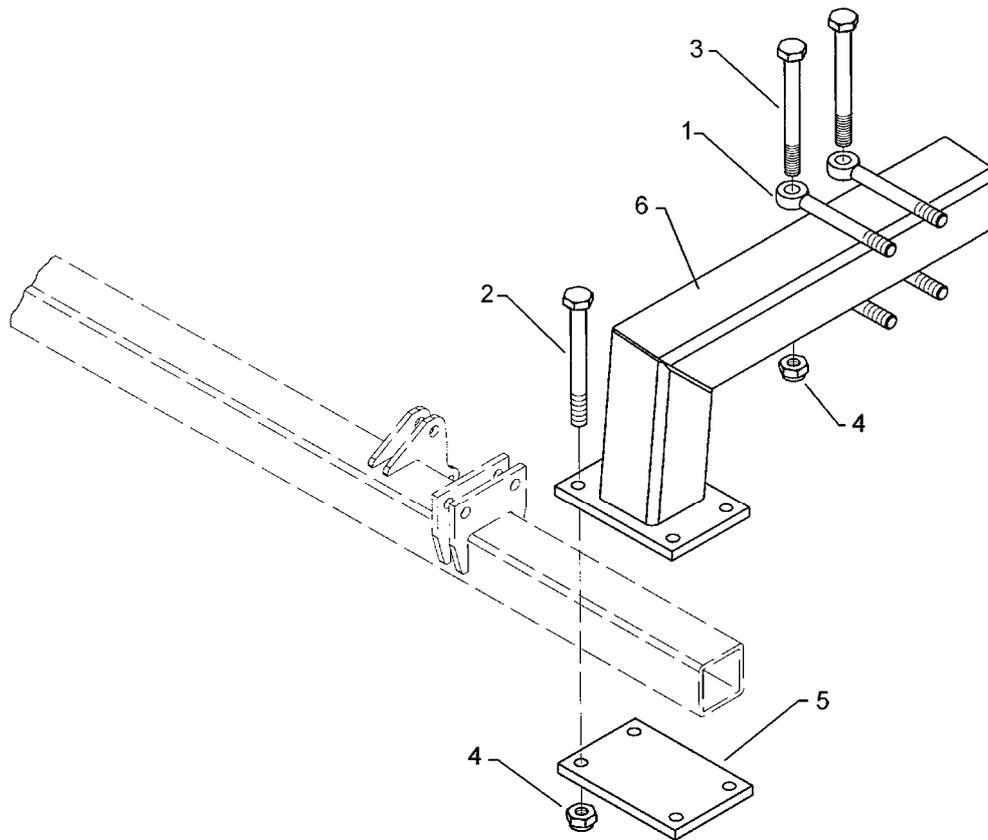

11.04

Pos.	Art.-Nr.	Stk.	Artikeltext / Description		Abmessung
1	301 0860	4	Augenschraube DIN444	Eye bolt	BM16x150-8.8 D2=16,1 Zn
2	301 4057	4	Sechskantschraube DIN931-A	Bolt	M16x130-8.8 Zn
3	301 5410	2	Sechskantschraube DIN931-A	Bolt	M16x160-8.8 Zn
4	303 0935	8	Sicherungsmutter	Selflocking nut	DIN985-NM16-8 Zn
5	459 9351	1	Klemmplatte	Clamping plate	15x140x210 4xD17
6	482 1291	1	Konsole zum Spuranreißer	Bracket for track marker	Smaragd 9 KA 6M LI
7	301 4118	2	Sechskantschraube	Bolt	M16x1,5x162ls140xb19-10.9
8	303 1017	2	Sechskantmutter	Nut	M16x1,5 DIN934-10 Zn

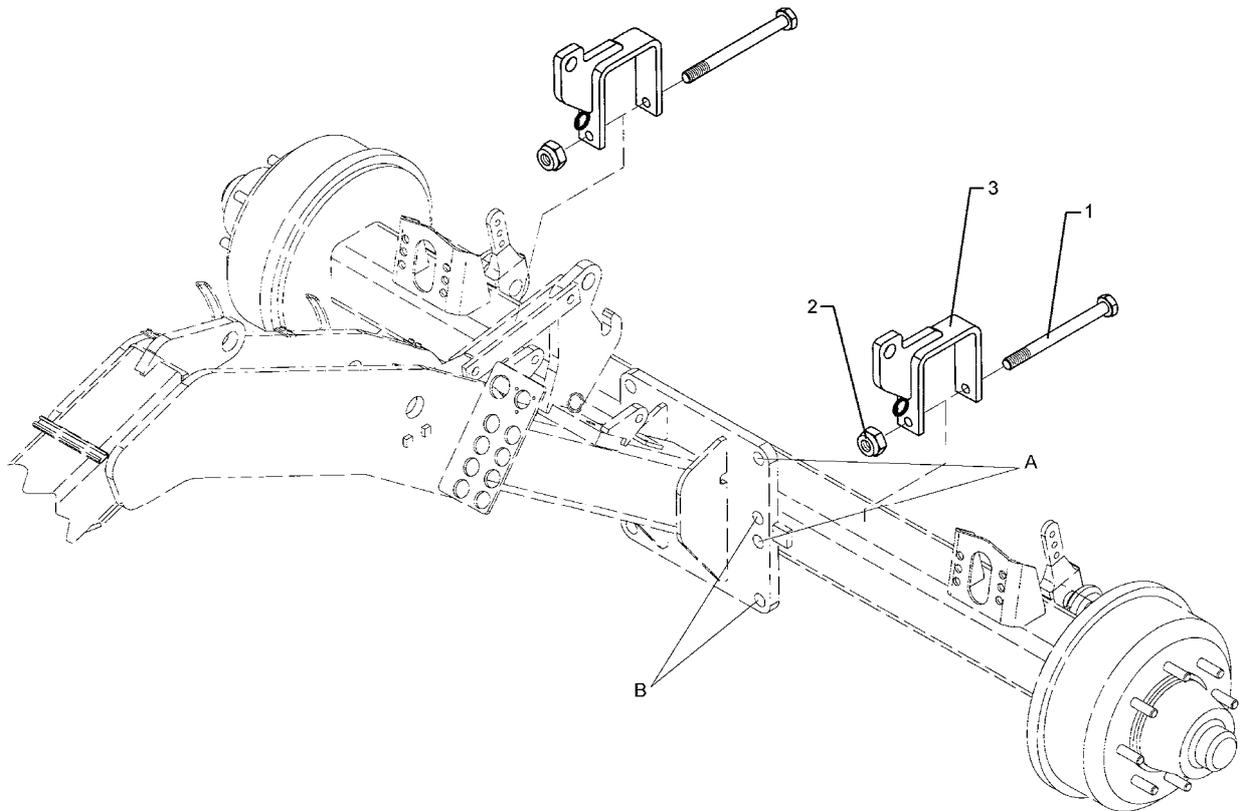

11.04

Pos.	Art.-Nr.	Stk.	Artikeltext / Description	Abmessung	
1	301 4556	2	Sechskantschraube DIN931-A	Bolt	M20x220-8.8 Zn
2	303 0936	2	Sicherungsmutter	Selflocking nut	DIN985-NM20-8 Zn
3	461 8366	2	Anbaukonsole	Bracket	150x150x60 D32

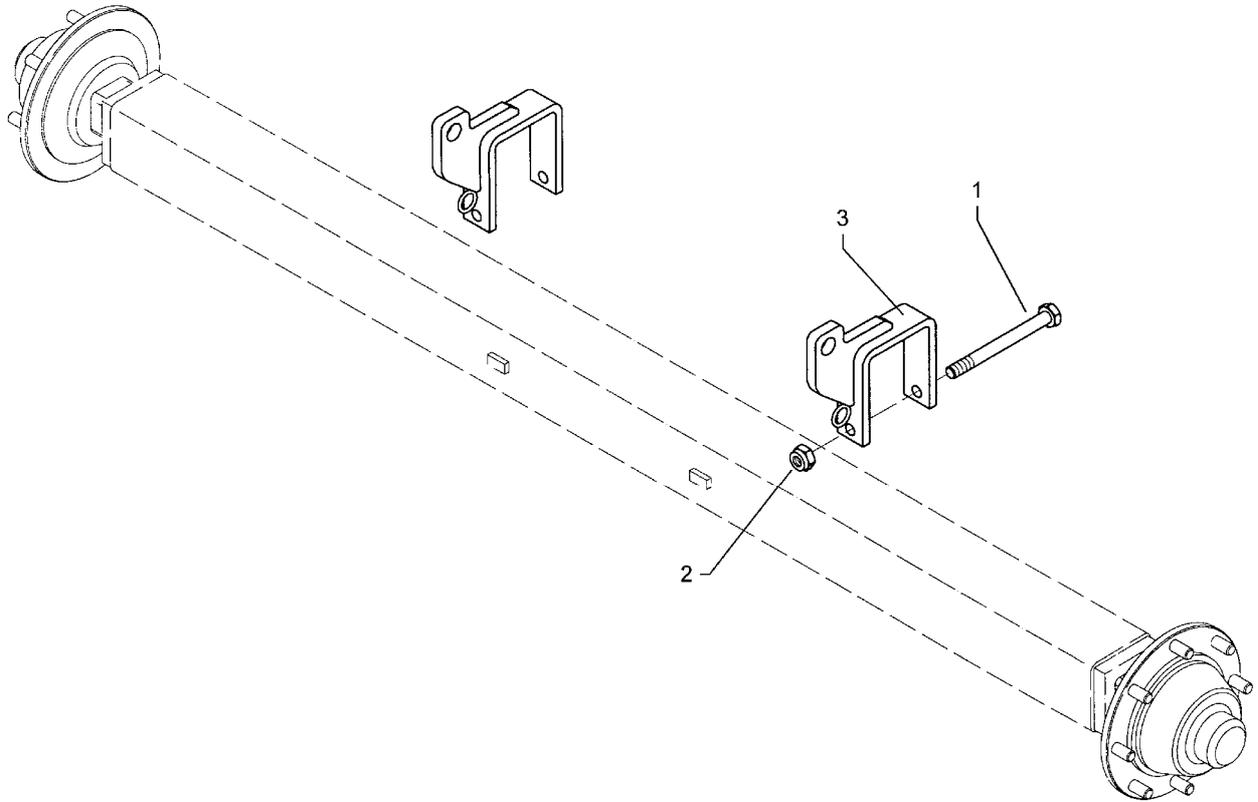

11.04

Pos.	Art.-Nr.	Stk.	Artikeltext / Description		Abmessung
1	301 4548	2	Sechskantschraube DIN931-A	Bolt	M20x200-8.8 Zn
2	303 0936	2	Sicherungsmutter	Selflocking nut	DIN985-NM20-8 Zn
3	461 8368	2	Anbaukonsole	Bracket	140x140x60 D32

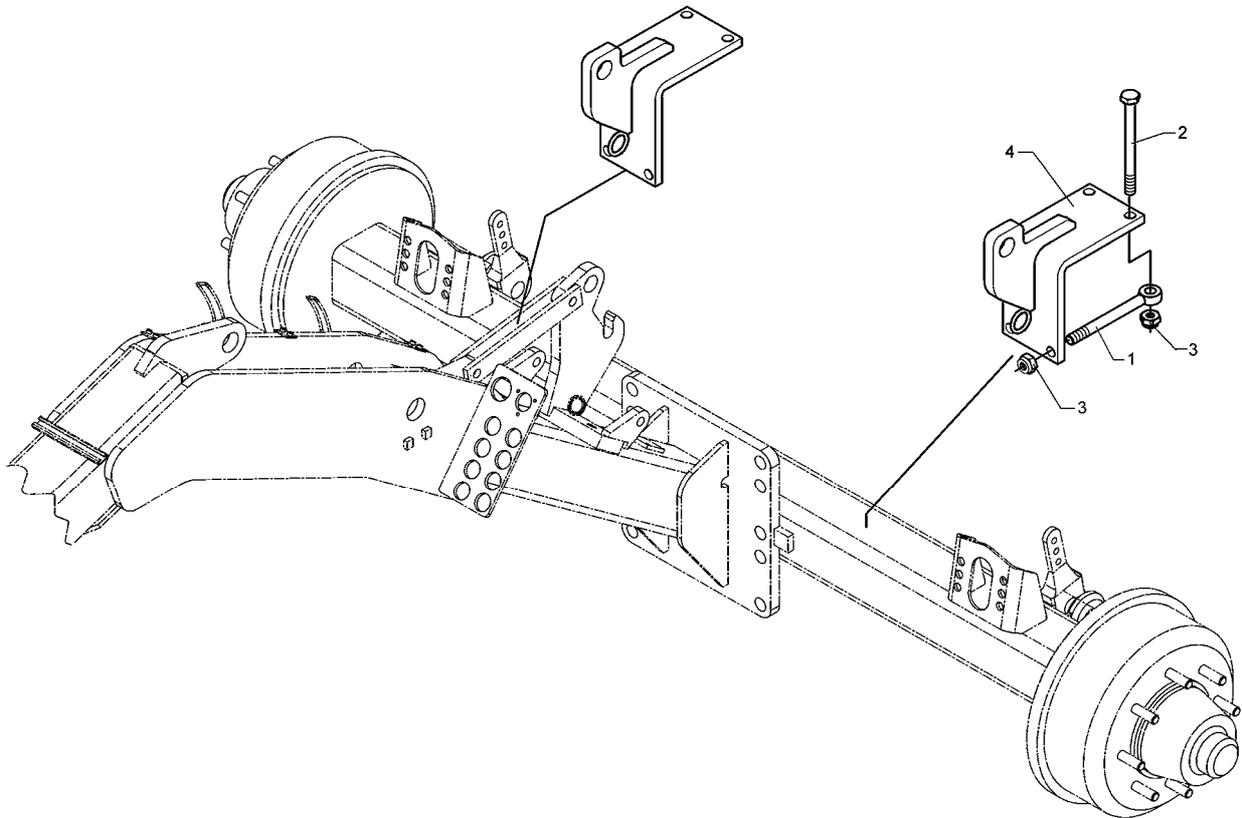

11.04

Pos.	Art.-Nr.	Stk.	Artikeltext / Description		Abmessung
1	301 0864	4	Augenschraube DIN444	Eye bolt	BM16x200xb100-8.8 D2=16,1 Zn
2	301 4134	4	Sechskantschraube spz.	Bolt	M16x200xb100-8.8 Zn
3	303 0935	8	Sicherungsmutter	Selflocking nut	DIN985-NM16-8 Zn
4	461 8369	2	Anbaukonsole	Bracket	150x150x120 D32

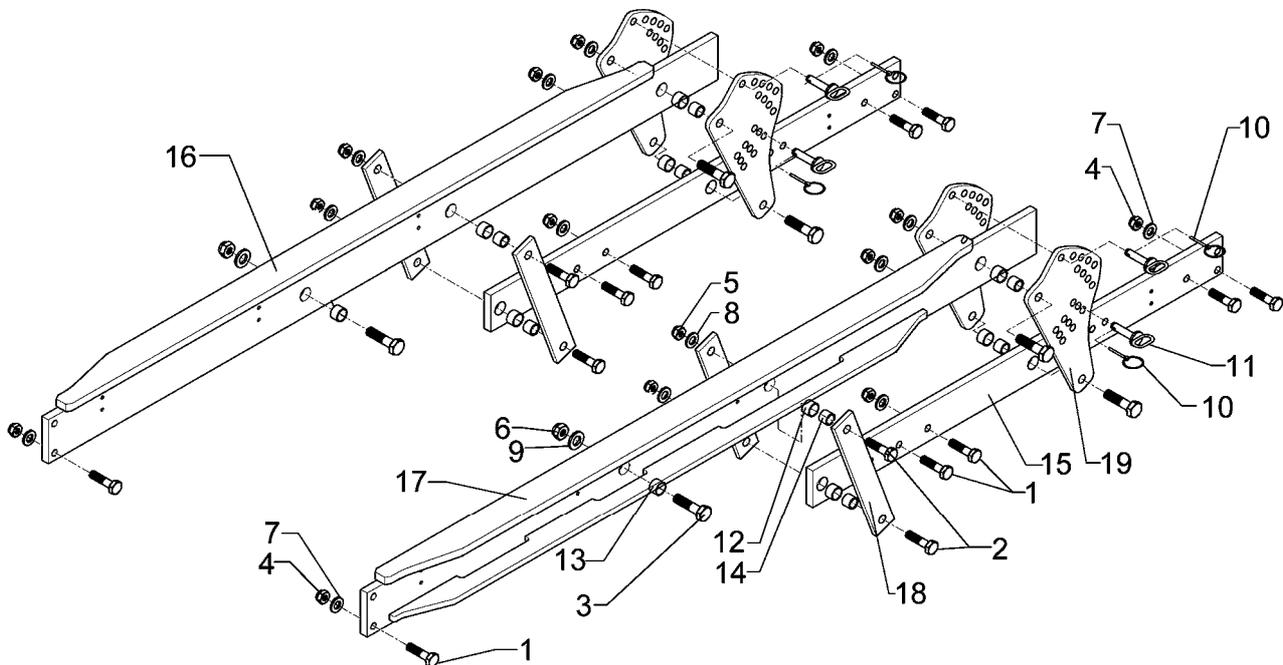

11.04

Pos.	Art.-Nr.	Stk.	Artikeltext / Description		Abmessung
1	301 3870	8	Sechskantschraube spz.	Bolt	M16x65-10.9
2	301 4602	8	Sechskantschraube spz.	Bolt	M20x75-8.8
3	301 5392	2	Sechskantschraube spz.	Bolt	M24x85-8.8
4	303 0935	8	Sicherungsmutter	Selflocking nut	DIN985-NM16-8 Zn
5	303 0936	8	Sicherungsmutter	Selflocking nut	DIN985-NM20-8 Zn
6	303 0937	2	Sicherungsmutter	Selflocking nut	DIN985-NM24-8 Zn
7	305 6155	8	Scheibe	Washer	D30/17x6 St-37
8	305 6164	8	Scheibe	Washer	D35/20,5x5
9	305 6274	2	Scheibe	Washer	D50/25x8
10	311 9565	4	Klappstift	Securing pin	4,5mm
11	313 8140	4	Bolzen mit Griff	Pin with grip	GB D16x50,8/70 Zn
12	317 3352	8	Einspannbuchse mit Preßsitz	Expansion bush	EG28/32x20
13	317 3407	2	Einspannbuchse	Expansion bush	EG24/32x20-DIN1498
14	317 6657	8	Buchse	Bush	D20/28x22
15	417 8099	2	Träger	Carrier	100x20x1282 2xD32 11xD16 4xD7
16	417 8082	1	Träger	Carrier	120x20x2095-80x20-60x15 RE
17	417 8083	1	Träger	Carrier	120x20x2095-80x20-60x15 LI
18	417 8110	4	Lenker	Link	60x12x382
19	417 8111	4	Verstellplatte	Adjuster plate	12x406,5x209

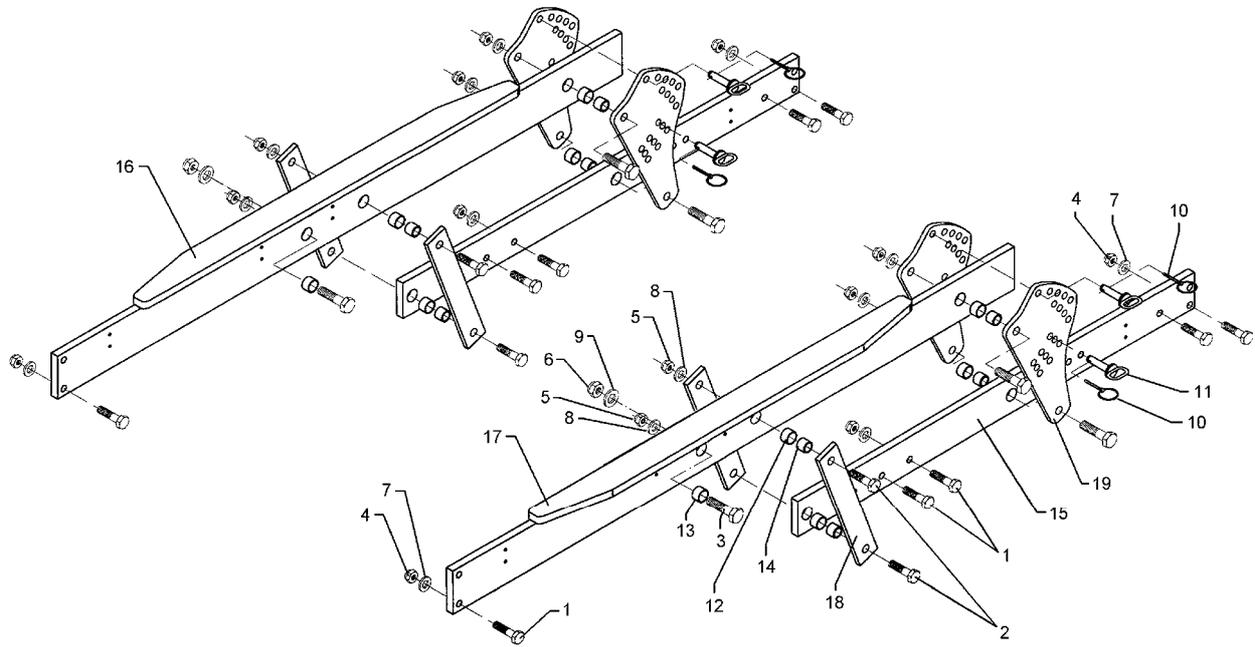

11.04

Pos.	Art.-Nr.	Stk.	Artikeltext / Description		Abmessung
1	301 3870	8	Sechskantschraube spz.	Bolt	M16x65-10.9
2	301 4602	8	Sechskantschraube spz.	Bolt	M20x75-8.8
3	301 5392	2	Sechskantschraube spz.	Bolt	M24x85-8.8
4	303 0935	8	Sicherungsmutter	Selflocking nut	DIN985-NM16-8 Zn
5	303 0936	8	Sicherungsmutter	Selflocking nut	DIN985-NM20-8 Zn
6	303 0937	2	Sicherungsmutter	Selflocking nut	DIN985-NM24-8 Zn
7	305 6155	8	Scheibe	Washer	D30/17x6 St-37
8	305 6164	8	Scheibe	Washer	D35/20,5x5
9	305 6274	2	Scheibe	Washer	D50/25x8
10	311 9565	4	Klappstift	Securing pin	4,5mm
11	313 8140	4	Bolzen mit Griff	Pin with grip	GB D16x50,8/70 Zn
12	317 3352	8	Einspannbuchse mit Preßsitz	Expansion bush	EG28/32x20
13	317 3407	2	Einspannbuchse	Expansion bush	EG24/32x20-DIN1498
14	317 6657	8	Buchse	Bush	D20/28x22
15	417 8099	2	Träger	Carrier	100x20x1282 2xD32 11xD16 4xD7
16	417 8086	1	Träger T-Profil	Carrier	120x20x1795-80x20x1200 RE
17	417 8087	1	Träger T-Profil	Carrier	120x20x1795-80x20x1200 LI
18	417 8110	4	Lenker	Link	60x12x382
19	417 8111	4	Verstellplatte	Adjuster plate	12x406,5x209

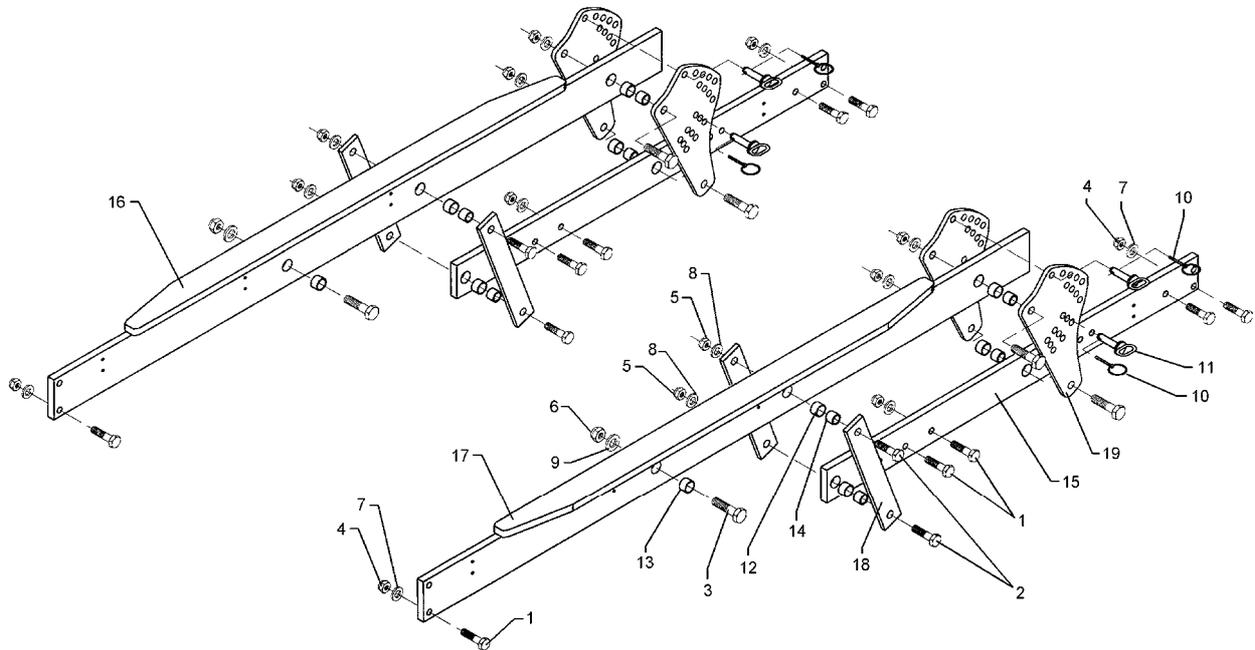

11.04

Pos.	Art.-Nr.	Stk.	Artikeltext / Description		Abmessung
1	301 3870	8	Sechskantschraube spz.	Bolt	M16x65-10.9
2	301 4602	8	Sechskantschraube spz.	Bolt	M20x75-8.8
3	301 5392	2	Sechskantschraube spz.	Bolt	M24x85-8.8
4	303 0935	8	Sicherungsmutter	Selflocking nut	DIN985-NM16-8 Zn
5	303 0936	8	Sicherungsmutter	Selflocking nut	DIN985-NM20-8 Zn
6	303 0937	2	Sicherungsmutter	Selflocking nut	DIN985-NM24-8 Zn
7	305 6155	8	Scheibe	Washer	D30/17x6 St-37
8	305 6164	8	Scheibe	Washer	D35/20,5x5
9	305 6274	2	Scheibe	Washer	D50/25x8
10	311 9565	4	Klappstift	Securing pin	4,5mm
11	313 8140	4	Bolzen mit Griff	Pin with grip	GB D16x50,8/70 Zn
12	317 3352	8	Einspannbuchse mit Preßsitz	Expansion bush	EG28/32x20
13	317 3407	2	Einspannbuchse	Expansion bush	EG24/32x20-DIN1498
14	317 6657	8	Buchse	Bush	D20/28x22
15	417 8099	2	Träger	Carrier	100x20x1282 2xD32 11xD16 4xD7
16	417 8078	1	Träger T-Profil	Carrier	120x20x2095-80x20x1500 RE
17	417 8079	1	Träger T-Profil	Carrier	120x20x2095-80x20x1500 LI
18	417 8110	4	Lenker	Link	60x12x382
19	417 8111	4	Verstellplatte	Adjuster plate	12x406,5x209

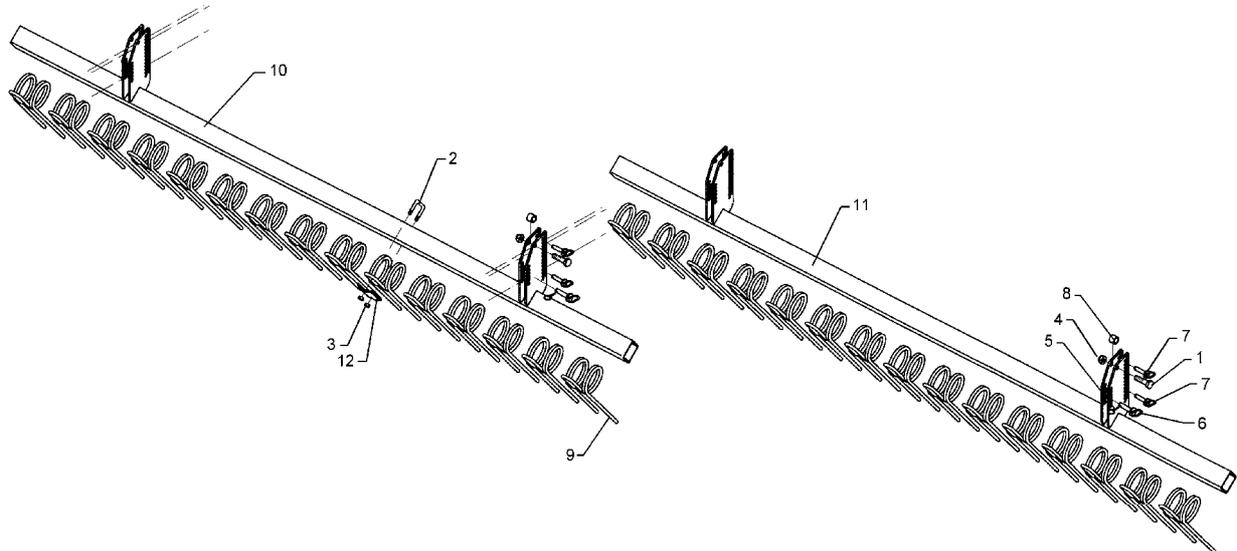

11.04

Pos.	Art.-Nr.	Stk.	Artikeltext / Description	Abmessung	
1	301 3837	4	Sechskantschraube DIN931-A	Bolt	M16x60-8.8 Zn
2	301 7785	30	Bügelsschraube	U-bolt	M10x80x110
3	303 0933	60	Sicherungsmutter	Selflocking nut	DIN985-NM10-8 Zn
4	303 0935	4	Sicherungsmutter	Selflocking nut	DIN985-NM16-8 Zn
5	311 9565	12	Klappstift	Securing pin	4,5mm
6	313 1530	4	Bolzen mit Griff	Pin with grip	GB D15x41,8/60
7	313 7807	8	Bolzen mit Griff	Pin with grip	GB D12x57,5/71
8	317 6658	4	Buchse	Bush	D16/22x22
9	353 8801	30	Striegelzinken	Harrow tine	STD/12mm
10	422 6386	1	Tragrohr für Striegel	Frame	80x80x4,5x2970-RE SM-9/600-K
11	422 6387	1	Tragrohr für Striegel	Frame	80x80x4,5x2970-LI SM-9/600-K
12	459 4560	30	Klemmplatte	Clamping plate	80x6x120 1x90-D11