





MANITOU PARTS

REFROIDISSEUR D'HUILE - OIL COOLER - ÖLKÜLHER - OLIE KOELER - REFRIGERADOR ACEITE

	N° de construction <i>Build number</i>	Ref.	
A4.236	LD, LJ, LH	44/6097-6 (P2486A219)	
1004.4	AA, AB, AE, AJ, AK, AQ, AR, AS		



Index

Index

- Accessoires batteries **27-29**
- Accessoires de cabine **53, 54**
- Allume-cigare **32**
- Alternateurs **44**
- Avertisseurs **32**

- Bielle **7**
- Bouchon de réservoir **12**
- Bougie de préchauffage **13**

- Climatisation **49**
- Commutateur d'éclairage **31**
- Contacteurs de démarrage **31**
- Courroie **16-18**
- Culasse & arbre à came **10**

- Démarreurs **44**
- Direction **39-41**
- Durites **15**

- Éclairage **33-35**
- Embrayages **36**
- Essuie-glace et accessoires **47**

- Filtre CAV **13**
- Filtres **19-26**
- Freins **37, 38**

- Hydraulique **45, 46**

- Index des références **57, 58**
- Interrupteurs **30**
- Inverseur de marche **31**

- Joints moteur **11**

- Manocontact de pression d'huile **29**
- Moteurs d'essuie-glace **48, 49**

- Nez d'injecteur **13**

- Peintures **54**
- Pistons, jeux de segments & chemises **8, 9**
- Poignées et serrures **51**
- Pompe à huile **12**
- Pompes à eau **14**
- Pompes d'alimentation **12**
- Pompes hydrauliques **42, 43**
- Prise de remorque **32**

- Air-conditioning **49**
- Alternators **44**

- Battery accessories **27-29**
- Brakes **37, 38**

- Cab accessories **53, 54**
- CAV filter **13**
- Cigar lighter **32**
- Clutch **36**
- Combined switches **31**
- Connecting rod **7**
- Crankshaft & related parts **7**
- Cross references **55-56**
- Cylinder head & Cam shaft **10**
- Cylinder head parts **10**

- Engine gasket **11**

- Filters **19-26**
- Fuel pump **12**

- Gas struts **52**

- Heater plug **13**
- Horn **32**
- Hoses **15**
- Hydraulic **45, 46**
- Hydraulic pumps **42, 43**

- Injector nozzle **13**

- Lightning **33-35**
- Locks & handles **51**

- Mirrors **52**

- Oil pressure switch **29**
- Oil pump **12**

- Paints **54**
- Pistons, ring sets & liners **8, 9**

- Reference index **57, 58**
- Reversers **31**

- Start motor **44**
- Starter switch **31**
- Steering **39-41**
- Switches **30**

Index

■ Références interchangeables	55-56
■ Rétroviseurs	52
■ Soupapes et pièces connexes	10
■ Transmission	37
■ Types & motorisation	5, 6
■ Vérins à gaz	50
■ Vilebrequins & pièces connexes	7

Index

■ Tank cap	12
■ Trailer plug	32
■ Transmission	37
■ Types & motorization	5, 6
■ 'V' Belt	16-18
■ Water pumps	14
■ Wiper and accessories	47
■ Wiper motors	48, 49

TYPES & MOTORISATION
TYPES & ENGINES

Types d'engins Machines types	Moteur Engine	Type Type
Chariot élévateur tout terrain / All road telescopic handlers		
MB20C, MB20CL, MB25C, MB30C, 4RM20C, 4RM25C, MC20C, MC25C, MC30C, MCE20C, MCE20H, MCE25C, MCE25H, MCE30C, MCE30H, MC40C, MB21C, MB26C	I.H	BD 154
Ancien montage moteur / Old engine fitting Tracteur / Tractor IH 137 France		D.111
4RM26N, 4RM30N, 4RM35B, C, 4RM36K, 4RM40B, 4RM40K, 4RM50K, MB26C, MB30C, MB30J, MB40, MB40B, MB50K, MC50K, MC60K		D.179 D.239
MC15A, MC18A	Ford	2274E
MB21JC, MB25PF, MB26JC, MB26NF, MB30JC, MB30NF, MC40C, MC		2512
MC.80, MC90, MC100		2714E
Ancien montage avec moteur Perkins / Old fitting with Perkins engine fabrication française / made in France	Perkins	P.3 France
4RM30, 4RE30HP, 4RE40HP		A.4.203
4RM30HP, 4RE30HP, 4RE40HP, 4RE60H, MB25P, MB60H, MB26NP, MB30NP		A.4.236
MSI 20, MSI 25, MSI 30		404 C22
MH20-4T Buggie, MH25-4T Buggie, MSI 35T		404 C22T
MSI 40, MSI 50		1004.42
MA 460, MA 470		1004.4 Turb.
Chariot télescopique "Maniscopic TWISCO" Telescopic handlers		
SLT 415, SLT 415B	LISTER PETTER	40 CV 4 cyl.
Chariot télescopique "Maniscopic TWISCO" Telescopic handlers		
BTI 220, BT 225, BT 420, BT425	Perkins	(39 CV)
Chariot télescopique "MANISCOPIC" Telescopic handlers		
MT.523 et autres MT,MLT moteur Atmosphérique 3 cyl. / MT.523 and other MT, MLT 3cyl. atmospheric engine	Perkins 3 Cyl.	903-27
MT.523 T et autres MT, MLT moteur Turbo 3 cyl. / MT.523 T and other MT, MLT 3cyl. turbo engine		903-27T
MT.523 et autres MT, MLT moteur Turbo 3 cyl. / MT.523 and other MT, MLT 3cyl. turbo engine		1103-C33 TURBO
Ancienne série M, MT Old series	Perkins 4 Cyl.	4,236
Ancienne gamme MT, MLT voir identification moteur / Old range MT, MLT see engine identification		T.4.236
Série MVT sauf MVT 665, MVT 675 Autre modèles MT, MVT, MLA, MLT, MRT: voir identification moteur MVT series except MVT 665, MVT 675 Other models MT, MVT, MLA, MLT, MRT: see engine identification		1004-4
MT.1637SLT, MRT 1432,MRT 1542, MTR 1650, MVT 665, MVT 675, MT.1637 ST, MT, MLT voir identification moteur / see engine identification		1004-4T
MT, MVT, MLA, MLT, MRT: voir identification moteur / see engine identification		1004-40

TYPES & MOTORISATION

TYPES & ENGINES

Types d'engins Machines types	Moteur Engine	Type Type
Chariot télescopique "MANISCOPIC" Telescopic handlers		
MLT.526-20 Turbo cabine Haute, MLT.526-24 Turbo, MRT.1432, MRT.1542, MRT.1650, MVT 665, MVT 675 Autre modèles / Other models MT, MVT, MLA, MLT, MRT: voir identification moteur / see engine identification	Perkins 4 Cyl.	1004-40T
MLA.628, MLA 628 - 120 LS PS Autre modèles / Other models MT, MVT, MLA, MLT, MRT: voir identification moteur / see engine identification		1004-40TW
MLT.526-20 Compact cabine basse / Complete low cab, Series MVT sauf / except MVT 665, MVT.675 Autre modèles / Other models MT, MVT, MLA, MLT, MRT: voir identification moteur / see engine identification		1004-42
MT 732, MT 932, MT 1030 S, MT 1033, MT.1235S, MT.1330 SL, MT.1337SL, MT.1637SL Autre modèles / Other models MT, MVT, MLA, MLT, MRT: voir identification moteur / see engine identification		1104C.44
MVT.628T, MLT.627-20, MLT 627-24, MLT.630, MLT.634, MLT.731, MT 1033 HLT, MLT 742 HT LSU, MLT 845 HT LSU, MT.1235ST, MT 1240LT, MT.1335 HSLT, 1337 SLT, 1340 SLT, MT.1637 SLT, MT.1740 SLT, MT.1745 HSLT, MRT.1432, MRT.1542, MRT.1365,, MRT.1742, Autre modèles / Other models MT, MVT, MLA, MLT, MRT: voir identification moteur / see engine identification		1104C - 44T
MLT.634, MLT 735, MLT 741, MLT 845-120 LSU, MLT 940 L-120 LSU, MRT.1850, MRT.2150, MRT.2440 EPS, MRT.2540 Autre modèles / Other models MT, MVT, MLA, MLT, MRT: voir identification moteur / see engine identification		1104.44 TA
MHT.10120L, MHT.10160L Autre modèles / Other models MHT: voir identification moteur / see engine identification	Mercedes	OM904LA TURBO

VILEBREQUIN & PIÈCES CONNEXES
CRANKSHAFT & RELATED PARTS

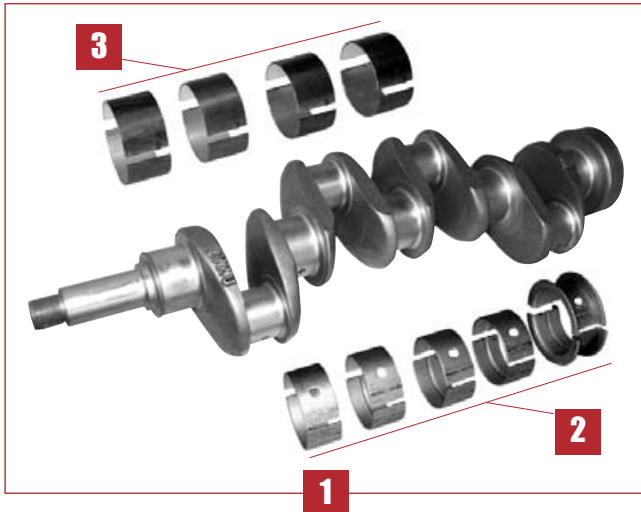

Types d'engins Machines types	Mot. Mot.	Jeu vilebr. Crankshaft kit	Cous. palier Main bearing	Cous. bielle Conrod bearing	Bague bielle Small end bush	Bague avant Fr. oil seal	Bague arr. Rear oil seal
		1	2	3	4	5	6
Moteurs CASE-IH / CASE-IH engine							
MB20C, MB20CL, MB25C, MB30C, 4RM20C, 4RM25C, MC20C, MC25C, MC30C, MCE20C, MCE20H, MCE25C, MCE25H, MCE30C, MCE30H, MC40C, MB21C, MB26C	BD154	44/1-109 (49261)	44/2-109 (49005)	44/3-109 (49544)	44/28-109 (49011)	44/11-109 (49008)	44/13-109 (49009)

BIELLE ASSEMBLÉE
CONNECTING ROD

Types d'engins Machines types	Moteur Engine	Réf. Ref.
Moteurs CASE-IH / CASE-IH engine		
MB20C, MB20CL, MB25C, MB30C, 4RM20C, 4RM25C, MC20C, MC25C, MC30C, MCE20C, MCE20H, MCE25C, MCE25H, MCE30C, MCE30H, MC40C, MB21C, MB26C	BD154	44/25-29 (49174)



PISTONS, JEUX DE SEGMENTS & CHEMISES PISTONS, RING SETS & LINERS



Types d'engins Machines types	Type Type	Alésage Boring	Jeu (A) Kit set (A)	Piston Piston	Jeu de segments Ring set	Chemise Liner	Joint de chem. Liner seal
			1	2	3	4	5
Moteurs CASE-IH / CASE-IH engine							
Anciens modèles France Old models France	D111	87.30	44/31-225		44/34-185 (3050149R92)		44/38-11 (714854R1)
MB20C, MB20CL, MB25C, MB30C, 4RM20C, 4RM25C, MC20C, MC25C, MC30C, MCE20C, MCE20H, MCE25C, MCE25H, MCE30C, MCE30H, MC40C, MB21C, MB26C	BD154	88.90	44/31-224 (49007)	44/33-188 (49541)	44/34-184 (49010)	44/35-78 (49537)	44/38-10 (49536)

(A) Avec joints de chemise / With liner seals

PISTONS PISTONS

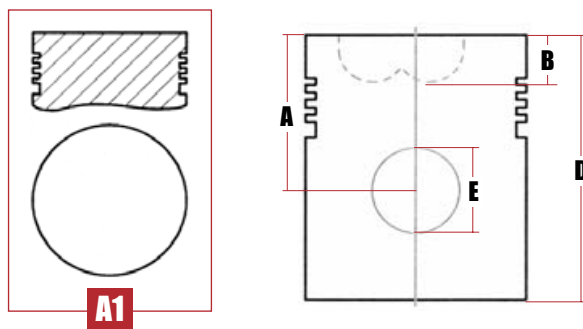

- A: Hauteur de compression (mm)
Compression height (mm)
- B: Profondeur chambre combustion (mm)
Combustion bowl depth (mm)
- D: Hauteur totale (mm)
Overall length (mm)
- E: Diamètre de l'axe de piston (mm)
Gudgeon pin diameter (mm)

Réf. Ref.	Moteurs Engines	Alésage Bore Ø	Type Type	Nbre segm. N° of rings	Al-fin Al-fin	A mm	B mm	D mm	E mm
44/33-188	BD154	88.90	A1	5	Non / No	50.90	-	99.00	28.00

Les références des pièces sont indicatives.
Nos pièces ne sont pas d'origine

"THE RELIABLE SERVICE"

Part numbers are quoted for reference purposes only.
Our parts and accessories are not original.



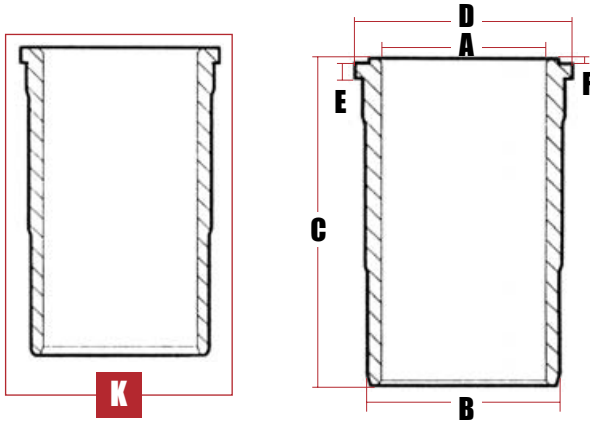



**CHEMISES
LINERS**

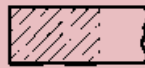

- A: Alésage (mm)
Nominal bore diameter (mm)
- B: Diamètre extérieur (mm)
Outside diameter (mm)
- C: Hauteur totale (mm)
Overall length (mm)
- D: Diamètre colerette (mm)
Flange diameter (mm)
- E: Hauteur colerette (mm)
Flange width (mm)
- F: Hauteur lèvres de feu (mm)
Fire lip height (mm)

Réf. Ref.	Moteur Engine	Type Type	A mm	B mm	C mm	D mm	E mm
44/35-78	BD154	K	88.90	93.65	185.73	101.70	5.82

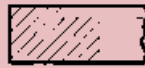
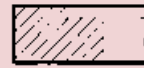
**JEUX DE SEGMENTS
RING SETS**

Réf. Ref.	Moteur Engine	Alésage Bore Ø	Segment Diagrams				
44/34-185	D111	87.30	 CP1 2.38	 P1 2.38	 P1 2.38	 SS 4.75	 SS 4.75
44/34-184	BD154	88.90	 CP1 2.38	 P2 2.38	 P2 2.38	 SS 4.76	 SS 4.76

CP1: Rectangulaire chromé / Chrome plated parallel faced

P1: Rectangulaire / Parallel faced plain

P2: Rectangulaire, épaulement intérieur en haut / Parallel faced internally stepped top

SS: Normal à fentes / Standard slotted

CULASSE & ARBRE À CAME CYLINDER HEAD & CAMSHAFT

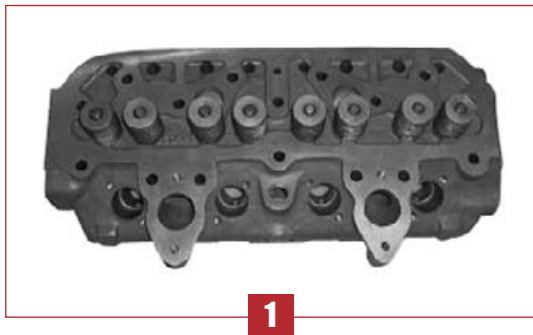

1



2

Types d'engins Machines types	Moteur Engine	Réf. Ref.	Description	Fig.
Moteurs CASE-IH / CASE-IH engine				
MB20C, MB20CL, MB25C, MB30C, 4RM20C, 4RM25C, MC20C, MC25C, MC30C, MCE20C, MCE20H, MCE25C, MCE25H, MCE30C, MCE30H, MC40C, MB21C, MB26C	BD154	44/40-10 (49138)	Culasse Cylinder head	1
		44/80-15 (49180)	Arbre à came Cam shaft	2

SOUPAPES ET PIÈCES CONNEXES CYLINDER HEAD PARTS

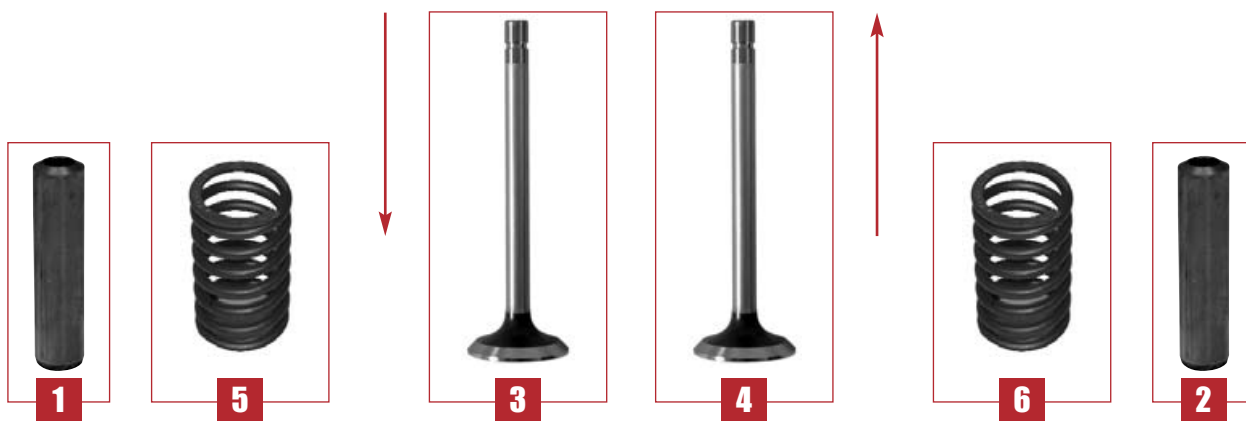

Types d'engins Machines types	Mot. Mot.	Guide admis. Inlet guide	Guide échap. Exhaust guide	Soup. d'admis. Inlet valve	Soup. d'échap. Exhaust valve	Ressort admis. Inlet spring	Ressort échap. Exhaust spring
		1	2	3	4	5	6
Moteurs CASE-IH / CASE-IH engine							
MB20C, MB20CL, MB25C, MB30C, 4RM20C, 4RM25C, MC20C, MC25C, MC30C, MCE20C, MCE20H, MCE25C, MCE25H, MCE30C, MCE30H, MC40C, MB21C, MB26C	BD154	44/41-31 (49139)	44/41-32 (49311)	44/42-29 (49003)	44/43-28 (49004)	44/44-22 (49364)	44/45-18 (49365)

Les références des pièces sont indicatives.
Nos pièces ne sont pas d'origine

"THE RELIABLE SERVICE"

Part numbers are quoted for reference purposes only.
Our parts and accessories are not original.

JOINTS MOTEUR
ENGINE GASKET

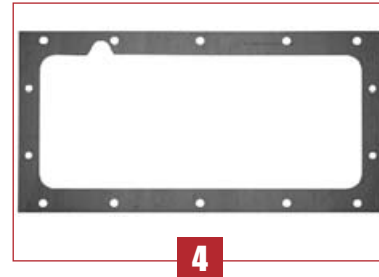
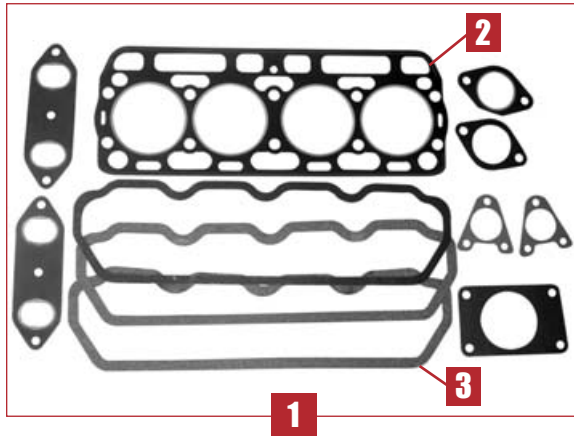

Types d'engins Machines types	Moteur Engine	Pochette rodage Top gasket set	Joint de culasse Cyl. head gasket	Jt cache soupape Rock.cover gask.	Joint de carter Sump gasket
		1	2	3	4
Moteurs CASE-IH / CASE-IH engine					
Ancien mod. tracteur IH137 Old tractor models IH137	D111	44/71-324	44/73-324	44/74-324	44/75-324

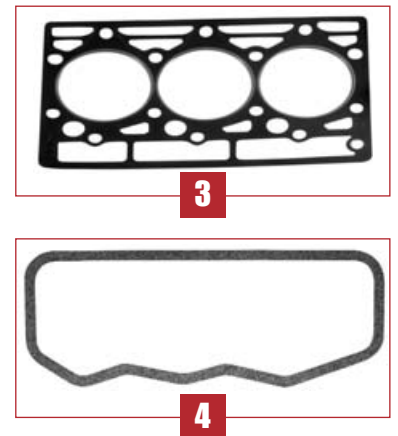
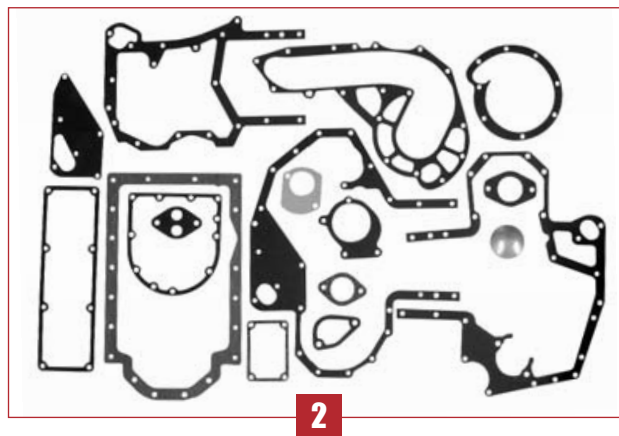
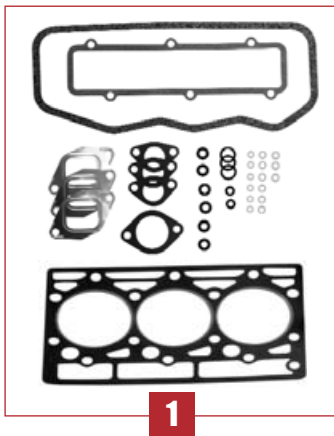

Types d'engins Machines types	Moteur Engine	Pochette rodage Top gasket set	Poch. complément. Bottom gasket set	Joint de culasse Cyl. head gasket	Jt cache soupape Rock.cover gask.
		1	2	3	4
Moteurs CASE-IH / CASE-IH engine					
MB20C, MB20CL, MB25C, MB30C, 4RM20C, 4RM25C, MC20C, MC25C, MC30C, MCE20C, MCE20H, MCE25C, MCE25H, MCE30C, MCE30H, MC40C, MB21C, MB26C	BD154	44/71-325	44/72-325 (B1036)	44/73-325	44/74-325

Les références des pièces sont indicatives.
Nos pièces ne sont pas d'origine

"THE RELIABLE SERVICE"

Part numbers are quoted for reference purposes only.
Our parts and accessories are not original.

POMPE À HUILE OIL PUMP

Types d'engins Machines types	Moteur Engine	Réf. Ref.
Moteurs CASE-IH / CASE-IH engine		
MB20C, MB20CL, MB25C, MB30C, 4RM20C, 4RM25C, MC20C, MC25C, MC30C, MCE20C, MCE20H, MCE25C, MCE25H, MCE30C, MCE30H, MC40C, MB21C, MB26C	BD154	44/90-82 (3064060R91)



BOUCHON DE RÉSERVOIR TANK CAP

Types d'engins Machines types	Réf. Ref.	Description	Fig.
MT, MLA, MLT, MVT, MRT	44/105-41 (62415)	Ø ext. : 75	

POMPES D'ALIMENTATION FUEL PUMP

Types d'engins Machines types	Moteurs Engines	Réf. Ref.	OEM	Fig.
Moteurs CASE-IH / CASE-IH engine				
MB20C, MB20CL, MB25C, MB30C, 4RM20C, 4RM25C, MC20C, MC25C, MC30C, MCE20C, MCE20H, MCE25C, MCE25H, MCE30C, MCE30H, MC40C, MB21C, MB26C	BD 154	44/100-112	708294R93, 49071	1
Moteurs Perkins engines				
MT, MLA, MLT, MVT, MRT	1004-4 & T	44/100-113	ULPK0005, 549553	2

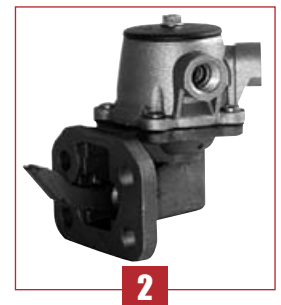

FILTRE CAV
CAV FILTER

1

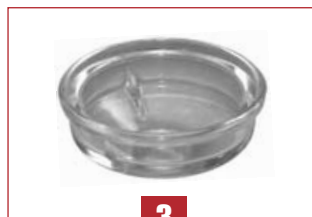
2

3

Types d'engins Machines types	Moteur Engine	Filtre Filter	Bol fond plat Flat bottom bowl	Bol fond convexe Convex bottom bowl
		1	2	3
Moteurs CASE-IH / CASE-IH engine				
MB20C, MB20CL, MB25C, MB30C, 4RM20C, 4RM25C, MC20C, MC25C, MC30C, MCE20C, MCE20H, MCE25C, MCE25H, MCE30C, MCE30H, MC40C, MB21C, MB26C	BD154	60/110-2 (49667)	60/112-1 (49206, 476170)	60/112-2 (477419)

NEZ D'INJECTEUR
INJECTOR NOZZLE

Types d'engins Machines types	Moteur Engine	N° du nez d'injecteur Injector nozzle N°	Réf. Ref.	OEM
Moteurs CASE-IH / CASE-IH engine				
MB20C, MB20CL, MB25C, MB30C, 4RM20C, 4RM25C, MC20C, MC25C, MC30C, MCE20C, MCE20H, MCE25C, MCE25H, MCE30C, MCE30H, MC40C, MB21C, MB26C	BD154	BDN4SD6299 5643095 0434250056	44/117-64	49750
MT425	Perkins	BDLL150S6649	44/117-211	

BOUGIE DE PRÉCHAUFFAGE
HEATER PLUG

Types d'engins Machines types	Moteurs Engines	Réf. Ref.	OEM	Fig.
Moteurs CASE-IH / CASE-IH engine				
MB20C, MB20CL, MB25C, MB30C, 4RM20C, 4RM25C, MC20C, MC25C, MC30C, MCE20C, MCE20H, MCE25C, MCE25H, MCE30C, MCE30H, MC40C, MB21C, MB26C	BD.154	44/60-44	49086	1
Moteurs Perkins engines				
Modèles divers Perkins Perkins various models	Perkins	44/60-45	133757 2666108	2

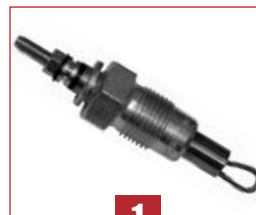
1

2

POMPES À EAU WATER PUMPS



1



2



3



4



5



6



7



8,9

Types d'engins Machines types	Moteurs Engine	Pompes Pumps	Kit de réparation Repair kit	Fig.
Moteurs CASE-IH / CASE-IH engine				
MB20C, MB20CL, MB25C, MB30C, 4RM20C, 4RM25C, MC20C, MC25C, MC30C, MCE20C, MCE20H, MCE25C, MCE25H, MCE30C, MCE30H, MC40C, MB21C, MB26C	BD 154	44/130-215 (49297,49190)		1
Ancien montage moteur IH 137 France <i>Old engine fitting</i>	DU 111	44/130-249		2
4RM26N, 4RM30N, 4RM35B, C, 4RM36K, 4RM40B, 4RM40K, 4RM50K, MB26C, MB26CJ, MB30C, MB30J, MB40, B, MB50K, MC50K, MC60K	D179, D239	44/130-250		3
Moteurs Perkins engines				
Ancien montage avec moteur Perkins fabrication française <i>Old fitting with Perkins engine (french made)</i>	P3 France	44/130-251		4
4RM30, 4RE30HP, 4RE40HP	4,203	44/130-252		5
4RM30HP, 4RE30HP, 4RE40HP, 4RE60H, MB25P, MB60H, MB26NP, MB30NP & autres montages / & other models M-ML-MLT <i>voir identification moteur / see engine identification</i>	4,236	44/130-253	44/131-253 (U7LW0058)	6
Ancienne gamme MT, MLT voir identification moteur <i>Old range MT, MLT see engine identification</i>	T.4.236	44/130-254 (U5MW0108)	44/131-254 (U7LW0096)	7
Série MVT sauf MVT 665, MVT 675 Autre modèles MT, MVT, MLA, MLT, MRT: voir identification moteur <i>Other models MT, MVT, MLA, MLT, MRT: see engine identification</i>	1004,4	44/130-255 (473724, U5MW0092)	44/131-255 (U7LW0151)	8
MT.1637SLT, MRT 1432, MRT 1542, MTR 1650, MVT 665, MVT 675, MT.1637 ST Autre modèles MT, MVT, MLA, MLT, MRT: voir identification moteur <i>Other models MT, MVT, MLA, MLT, MRT: see engine identification</i>	1004.4T	44/130-256 (U5MW0157)		9

DURITES DE REFROIDISSEMENT
HOSES



1 Ø 40 x 60



2 Ø 35 x 35



3 Ø 41 x 51



4 Ø 41 x 51



5 Ø 41 x 48



6 Ø 41 x 54



7 Ø 42 x 54



8 Ø 41 x 51

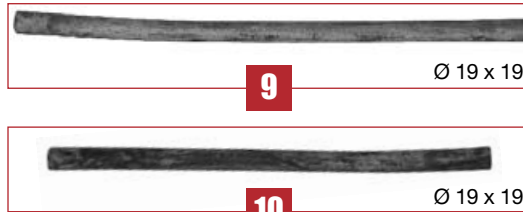

9 Ø 19 x 19



10 Ø 19 x 19

Types d'engins Machines types	Moteurs Engines	Durite supérieure Top hose	Fig.	Durite inférieure Bottom hose	Fig.
Moteurs CASE-IH / CASE-IH engine					
MB20C, MB20CL, MB25C, MB30C, 4RM20C, 4RM25C, MC20C, MC25C, MC30C, MCE20C, MCE20H, MCE25C, MCE25H, MCE30C, MCE30H, MC40C, MB21C, MB26C	I.H BD154	44/153-252	1	44/154-252	2
Moteurs Perkins engines					
MLT526 (Serie A), MLT526 Turbo, MLT526 Compact		44/153-122 (235137)	3		
MLT523, MLT526 Turbo, MLT524, MLT527, MLT626, MLT725 (Serie 2), MLT626, MLT725 Turbo, MLT626, MLT630, MLT725 (Serie 3), MLT628, MLT632, MLT728		44/153-121 (188920)	4		
MLT524, MLT527, MLT524, MLT527 Turbo				44/154-121 (226426)	5
MLT626, MLT626 Turbo				44/154-122 (78745)	6
MLT629, MLT730, MLT629, MLT730 Turbo		44/153-123 (234944, 224718)	7	44/154-120 (234945)	8
Vase expansion / Mud of expansion					
MLT526 (Serie A), MLT526 Turbo, MLT526 Compact		44/140-2 (234133)			9
MLT628, MLT632, MLT728 Turbo		44/140-1 (209847)			10

Moteurs Engine	Réf. Ref.	Mesures Sizes	Description	Fig.
Moteurs Perkins engines				
4.236 AT.4.236 1004-4 1004-T 1004TI	70/tub-1220	20 x 25mm	Longueur 1m utilisable en coude et contre coude Length 1 m foldable on both side	1
	70/tub-1225	25 x 31mm		
	70/tub-1231	31,5 x 36mm		
	70/tub-1233	33,5 x 38mm		
	70/tub-1237	37 x 44mm		
	70/tub-1244	44 x 48mm		
	70/tub-1248	48 x 55mm		
	70/tub-1255	55 x 65mm		
	70/tub-1265	65 x 75mm		
70/tub-1280	80 x 88mm			

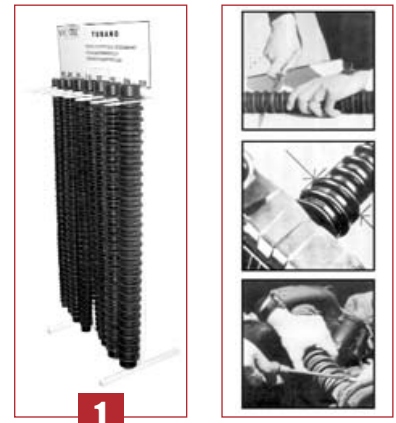

1

Les références des pièces sont indicatives.
Nos pièces ne sont pas d'origine

"THE RELIABLE SERVICE"

Part numbers are quoted for reference purposes only.
Our parts and accessories are not original.

COURROIES V BELTS



Types d'engins Machines types	Moteurs Engines	Ventilateur Fan	Alternateur Alternator	Dynamo Dynamo
MB20C, MB20CL, MB25C, MB30C, 4RM20C, 4RM25C, MC200C, MC250C, MC300C, MCE200C, MCE250C, MCE300C	BD 154	44/144-500 (49013, AVX 17-825)	44/144-519 (49014, AVX 10-775)	44/144-526 (49057, AVX 13-750)

COURROIES (POMPE À EAU - ALTERNATEUR) V BELTS (WATER PUMP - ALTERNATOR)

Types d'engins Machines types	Pompe à eau - Alternateur Water pump - Alternator	OEM	Mesures Sizes
M2-26/30CP, M4-26/30/40/50CP MC 30/40-50-60, MCE 40CP	44/144-501	109437	AVX 13 x 1290
M26-2/M26-4/M30-2/M30-4/M40-4/M50-4/MC30, MC40/50/60/70 Powershift MLT523/526 & T série 1 & 2, Série 2C MLT 524/527 & T mono Ultra série 1 MLT .626/725 & T Ultra série 2 MLT.626/630/725 & T Ultra/Mono Ultra série 3 MLA.627 MLT.628/632/728 & T Mono Ultra/Powershift série 1 MT.727/927 série C MT.728-2/MT.728-4/MT.928-4 & T série 1 MA.460/470 (⇒N° 140953 & N° 148469)	44/144-502	474948	AVX 13 x 1405
MLT523-526 & T série 1 & 2 series MLT .626/725 & T Ultra serie 2	44/144-503	473557 473722	AVX 13 x 1375
M26-2/M26-4/M30-2/M30-4/M40-4/M50-4/MC30, MC40/50/60/70 - MC60/70 T & Powershift, MLT.626/630/725 & T Ultra/Mono Ultra série 3 MT.727/927 série C	44/144-503 Pays chaud Hot country	473557 473722	AVX 13 x 1375
MLT 523 & T série A MLT 524-527 & T mono Ultra série 1 MLT.628/632/728 & T Mono Ultra/Powershift série 1 MT.728-2/MT.728-4/MT.928-4 & T série 1 MSI.20/25/30D Nacelle 150-/170 ATT, 150 ATS série 1 & 2, 165 ATJ	44/144-504 Sans climatisation Without airco Pays chaud Hot country	561299	AVX 13 x 1362
MLT 523 & T série A	44/144-520	231803	AVX 13 x 680
MLT.526 & T Compact série A MLT.629/730 & T & Powershift série 1 MLT.629/633/730-120LS & T & Powershift série A ML.632/635 & T série 2 MLT 633/730 T LS série 1 MLT.633/730-120 LS & Powershift série 1 MLT.633/730 & Powershift série A MT.732/932 & T série A, MT.732/932 & T série 1 MT.835-120 LS série 2 MT.845/940L & T & T Mono Ultra série 2 MT.845H/940H L & Turbo Série 1 MT.1233/1240L & T & T mono Ultra série 2 MT.1330/1337 SL/1637 SL & T & T Mono Ultra série 2 MT.1332H SL/ 1637 H SL & T & T Mono Ultra	44/144-521 Premier montage First fitting	563270	AVX 13 x 1250

Les références des pièces sont indicatives.
Nos pièces ne sont pas d'origine

"THE RELIABLE SERVICE"

Part numbers are quoted for reference purposes only.
Our parts and accessories are not original.

COURROIES (POMPE À EAU - ALTERNATEUR)
'V' BELTS (WATER PUMP - ALTERNATOR)

Types d'engins <i>Machines types</i>	Pompe à eau - Alternateur <i>Water pump - Alternator</i>	OEM	Mesures <i>Sizes</i>
MLT.629/730 & T & Powershift série 1 ML.632/635 & T série 2 MLT 633/730 T LS série 1 MLT.633/730-120 LS & Powershift série 1 MLT.633/730 & Powershift série A MT.732/932 & T série A MLT.629/633/730-120LS & T & Powershift série A MT.732/932 & T série 1 MT.835-120 LS série 2 MT.845/940L & T & T Mono Ultra série 2 MT.845H/940H L & Turbo Série 1 MT.1233/1240L & T & T mono Ultra série 2 MT.1330/1337 SL/1637 SL & T & T Mono Ultra série 2 MT.1332H SL/ 1637 H SL & T & T Mono Ultra	44/144-505 2ème montage <i>Sec. fitting</i> 2-9J1795	223258 257524	AVX 10 x 1780
MLT.629/730 & T & Powershift série 1 MLT.629/633/730-120LS & T & Powershift série A MLT 633/730 T LS série 1 MLT.633/730-120 LS & Powershift série 1 MLT.633/730 & Powershift série A MT.732/932 & T série A	44/144-518 Avec climatisation <i>With airco</i>	503965	AVX 13 x 1050
MRT.1430/1540/1840 MRT.1432/1542 Mot.1004-4T/1004-40T MRT.1650 Mot.1004-4T/1004-40T MRT.1850, MRT.2145 MVT.665/675 Mot.1004-4T/1004-40T, et Autres modèles MVT / & <i>other MVT models</i>	44/144-518		AVX 13 x 1050
ML.632/635 & T série 1 MT.835 Mono Ultra & T MT.845/940L & T & T Mono Ultra série1 MT.1232S/1240L & T & T Mono Ultra série 1 MT.1330/1337 SL/1637 SL & T & T Mono Ultra série 1	44/144-523	477791 476152	AVX 13 x 1200
ML.632/635 & T série 1, MT.835 Mono Ultra & T MT.845/940L & T & T Mono Ultra série1 MT.1232S/1240L & T & T Mono Ultra série 1 MT.1330/1337 SL/1637 SL & T & T Mono Ultra série 1	44/144-506 Pays chaud <i>Hot country</i> (N° 123854 ⇒ N° 129233)	208756	AVX 13 x 1783
MT.835 Mono Ultra & T MT.845/940L & T & T Mono Ultra série1 MT.1232S/1240L & T & T Mono Ultra série 1 MT.1330/1337 SL/1637 SL & T & T Mono Ultra série 1	44/144-507 Pays chaud <i>Hot country</i> (⇒ N° 123853)	216933	AVX 13 x 1740
ML.630 MT.830/840/930CP & T & Ultra, MT.930/1230 SCP & T & Ultra MT.930/1235 CP & CPT 10°/10° Ultra MT.1230 SCPsérie C MT.1235 CP 10°/10° & T & série C MT.1530 SCP série C & Ultra & T MSI 40/50 (⇒ N° 142126)	44/144-508	476010	AVX 10 x 1485

Les références des pièces sont indicatives.
Nos pièces ne sont pas d'origine

"THE RELIABLE SERVICE"

Part numbers are quoted for reference purposes only.
Our parts and accessories are not original.

COURROIES (POMPE À EAU - ALTERNATEUR) V BELTS (WATER PUMP - ALTERNATOR)

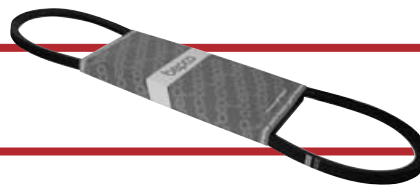

Types d'engins Machines types	Pompe à eau - Alternateur Water pump - Alternator	OEM	Mesures Sizes
MSI 40/50	44/144-509	601464	AVX 13 x 1510
MLA.628 T série 1 MA.460/470	44/144-510 (⇒ N° 140954) Sauf / Except N° 148469	564636	AVX 13 x 1425
TMD.12	44/144-511	565666	AVX 10 x 888
TMT.315-3 SIFL, TMT.320-3 & SI & SIFL & FL TMT.320/322/325 & FL & SI & FL HT & T	44/144-513 Poulie Vilebrequin Crankshaft pulley 90mm	549800	4 x 900
	44/144-514 Poulie Vilebrequin Crankshaft pulley 124mm	552500	4 x 925
BT.420/425, BTI 220/225 série 2	44/144-515	475499	AVX 13 x 965
MSI 20/25/30 & Buggie	44/144-516	1637718E	AVX 17 x 1240
	44/144-517	90916-02952-71	AVX 13 x 1170

FILTRES
FILTERS



1



2



3



4

Types d'engins Machines types	Air		Huile Oil	Combustible Fuel	Hydraulique Hydraulic
	Ext. / Out.	Int. / Inn.			
	1		2	3	4
150 / 170 ATT - 150 ATS Serie 1 & 2 - 165 ATJ		60/162-209 (177178)			
2000L Mainreach Perkins 4.203 Moteur / Engine	60/161-209 (177129)		60/96-2 60/97-1 (106387)	60/111-3 (49660)	
2600 Mainreach Perkins 1004.4 T Moteur / Engine	60/161-208 (177130)		60/97-2 (133755)		
4500, 4600 Detroit Diesel 12V-71 Moteur / Engine				60/111-45	
BT 420 / 425 - BTI 220 / 225 Serie 2	60/161-209 (177129)	60/162-209 (177178)			
M2 26 / 30 CP, M4 26 / 30 / 40 / 50 CP MC 30 / 40 / 50 / 60, MCE 40 CP	60/161-208 (177130)	60/162-208 (177179)			
MA 460 / 470	60/161-207 (185578) ⇒ 140953 + 148468	60/162-207 (484952) ⇒ 140953 + 148468	60/97-2 (133755)		
	60/161-206 (563416) 140954 ⇒ Except 148468	60/162-206 (563415) 140954 ⇒ Except 148468			
MB21C, MB26C IH BD154 Moteur / Engine	60/161-209 (177129)		60/96-1 (49445)	60/111-3 (49660)	
	60/161-208 (177130)				
MB21JC, MB25PF, MB26JC, MB26NF, MB30JC, MB30NF Ford 2515 Moteur / Engine	60/161-38 (169469)		60/96-7 60/97-56 (105548)		60/97-36 (136163)
MB25NP, MB60H Perkins 4.236 Moteur / Engine	60/161-38 (169469)		60/97-3 (476954)		
			60/96-3 60/97-2 (133755)		

Les références des pièces sont indicatives.
Nos pièces ne sont pas d'origine

"THE RELIABLE SERVICE"

Part numbers are quoted for reference purposes only.
Our parts and accessories are not original.

FILTRES FILTERS

Types d'engins Machines types	Air		Huile Oil	Combustible Fuel	Hydraulique Hydraulic
	Ext. / Out.	Int. / Inn.			
	1		2	3	4
MB26C, MB30C IH D179 Moteur / Engine	60/161-208 (177130)			60/111-25	
	60/161-209 (177129)			60/111-3 (49660)	
MB26J, MB30J IH D179 Moteur / Engine	60/161-208 (177130)				
MB26NP, MB30NP Perkins 4.236 Moteur / Engine			60/97-2 (133755)	60/111-3 (49660)	
			60/97-3 (476954)		
MB40, MB40B IH D179 Moteur / Engine				60/111-25	
MB40, MB40B IH D239 Moteur / Engine			60/97-39 (128680)	60/111-3 (49660)	
MB50K, MC50K, MC60K IH D179, D239 Moteur / Engine					
MC8			60/96-1 (49445)	60/111-3 (49660)	
			60/96-3		
MC15A, MC18A Ford 2274E Moteur / Engine			60/97-30 (136508)		
MC20C, MC20H, MC25C, MC25H, MC30C, MC30H, MC40C / IH BD154 Moteur / Engine			60/96-1 (49445)		
MCE20C, MCE25C, MCE30C IH BD154 Moteur / Engine					
MC 30, M26-2, M26-4, M30-2, M40-4, M50-4 (⇒139093)	60/161-208 (177130) ⇒ 139093	60/162-208 (177179) ⇒ 139093			60/240-102 (561749)
	60/161-206 (563416) 139094 ⇒	60/162-206 (563415) 139094 ⇒			60/240-104 (221174)
MC 40 / 50 / 60 / 70 POWERSHIFT			60/97-2 (133755)	60/111-3 (49660)	
MC 60 / 70 Turbo POWERSHIFT	60/161-207 (185578) ⇒ 139093	60/162-207 (484952) ⇒ 139093			60/240-104 (221174)
	60/161-206 (563416) 139094 ⇒	60/162-206 (563415) 139094 ⇒			
MC40C, MC50 Ford 2512 Moteur / Engine			60/96-7		
			60/97-54		
MC80, MC90, MC100 Ford 2714E Moteur / Engine			60/96-14		

FILTRES
FILTERS

Types d'engins Machines types	Air		Huile Oil	Combustible Fuel	Hydraulique Hydraulic	
	Ext. / Out.	Int. / Inn.				
	1		2	3	4	
ML 630	60/161-208 (177130)	60/162-208 (177179)	60/97-2 (133755)	60/111-3 (49660)	60/240-102 (561749) 60/240-104 (221174)	
ML 632 / 635 (+ Turbo) Serie 2	60/161-206 (563416)	60/162-206 (563415)	60/97-2 (133755) Less Turbo 60/97-3 (476954) With Turbo			
ML 632 / 635 Serie 1	60/161-208 (177130)	60/162-208 (177179)	60/97-2 (133755)			
ML 632 / 635 Turbo Serie 1	60/161-207 (185578)	60/162-207 (484952)				
MLA 627						
MLA 628 Turbo Serie 1	60/161-207 (185578)	60/162-207 (484952)				
MLT 523 / 526 Serie 1	60/161-208 (177130)	60/162-208 (177179)	60/97-2 (133755)			
MLT 523 / 526 Turbo + Turbo MONO-ULTRA Serie 2	60/161-207 (185578)	60/162-207 (484952)				60/111-3 (49660)
MLT 523 / 526 Turbo Serie 1						60/111-26 (26560143)
MLT 523 Serie 2-C, MLT 523 MONO-ULTRA Serie 2-C, MLT 523 / 526 Serie 2, MLT 523 / 526 MONO-ULTRA Serie 2	60/161-208 (177130)	60/162-208 (177179)				
MLT 524 / 527 Serie 1 MLT 524 / 527 MONO-ULTRA Serie 1	60/161-208 (177130)	60/162-208 (177179)	60/97-2 (133755) Less Turbo 60/97-3 (476954) With Turbo			
	60/161-207 (185578)	60/162-207 (484952)				
MLT 524 / 527 Turbo Serie 1 MLT 524 / 527 Turbo MONO-ULTRA Serie 1	60/161-207 (185578)	60/162-207 (484952)				
MLT 526 (+ Turbo / COMPACT) Serie A	60/161-206 (563416)	60/162-206 (563415)		60/111-3 (49660)	60/240-102 (561749) 60/240-104 (221174)	
MLT 626 / 630 / 725 (+ ULTRA / MONO-ULTRA) Serie 3	60/161-208 (177130)	60/162-208 (177179)	60/97-2 (133755)			
MLT 626 / 630 / 725 Turbo (+ ULTRA / MONO-ULTRA) Serie 3	60/161-207 (185578)	60/162-207 (484952)				
MLT 626 / 725 (+ Turbo / ULTRA) Serie 2	60/161-207 (185578) With Turbo	60/162-207 (484952) With Turbo				
	60/161-208 (177130) Less Turbo	60/162-208 (177179) Less Turbo				

Les références des pièces sont indicatives.
Nos pièces ne sont pas d'origine

"THE RELIABLE SERVICE"

Part numbers are quoted for reference purposes only.
Our parts and accessories are not original.

FILTRES FILTERS

Types d'engins Machines types	Air		Huile Oil	Combustible Fuel	Hydraulique Hydraulic
	Ext. / Out.	Int. / Inn.			
	1		2	3	4
MLT 628 / 632 / 728 (+ MONO-ULTRA) Serie 1	60/161-208 (177130)	60/162-208 (177179)	60/97-2 (133755)	60/111-3 (49660)	60/240-102 (561749)
MLT 628 / 632 / 728 Turbo (+ MONO-ULTRA) Serie 1	60/161-207 (185578)	60/162-207 (484952)			60/240-104 (221174)
MLT 628 / 632 / 728 Turbo POWERSHIFT MONO-ULTRA Serie 1					60/240-104 (221174)
MLT 629 / 633 / 730.120 LS Serie AMLT 633 / 730 LS Turbo Serie A MLT 633 / 730.120 LS POWERSHIFT Serie A	60/161-206 (563416)	60/162-206 (563415)	60/97-3 (476954)		60/240-102 (561749)
MLT 629 / 730 (+ Turbo) Serie 1, MLT 633 / 730 Turbo POWERSHIFT Serie 1			60/97-2 (133755)		60/240-106 (236094)
MLT 629 / 730 Serie A, MT 732 / 932 Serie A			60/97-3 (476954)		60/240-102 (561749)
MLT 629 / 730 Turbo Série A MLT730 Turbo POWERSHIFT Serie A					60/240-103 (563483)
MLT 633 / 730 Turbo LS Serie 1 MLT 633 / 730.120 LS (+ POWERSHIFT) Serie 1			60/97-2 (133755)		60/240-102 (561749)
MRT 1430 / 1540 / 1840			60/97-2 (133755)		60/240-105 (563482)
MRT 1432 / 1542 / 1650 / 1850 / 2145			60/97-3 (476954)		
MSI 20 / 25 / 30 (+ BUGGIE) MSI 20 / 25 / 30 D (+ BUGGIE) MSI 20 / 25 / 30 G (+ BUGGIE)	60/161-209 (177129)	60/162-209 (177178)			
MSI 40 / 50	60/161-208 (177130) ⇒ 142126	60/162-208 (177179) ⇒ 142126	60/97-2 (133755)	60/240-104 (221174)	
	60/161-206 (563416) 142127 ⇒	60/162-206 (563415) 142127 ⇒			
MT 727 / 927 Serie C	60/161-208 (177130)	60/162-208 (177179)			
MT 728-2, MT 728-4, MT 928-4 Serie 1			60/240-102 (561749)		
MT 728-2, MT 728-4, MT 928-4 Turbo Serie 1	60/161-207 (185578)	60/162-207 (484952)		60/240-104 (221174)	

Les références des pièces sont indicatives.
Nos pièces ne sont pas d'origine

"THE RELIABLE SERVICE"

Part numbers are quoted for reference purposes only.
Our parts and accessories are not original.

FILTRES
FILTERS

Types d'engins Machines types	Air		Huile Oil	Combustible Fuel	Hydraulique Hydraulic	
	Ext. / Out.	Int. / Inn.				
	1		2	3	4	
MT 732 / 932 (+ Turbo) Serie 1	60/161-206 (563416)	60/162-206 (563415)	60/97-2 (133755)	60/111-3 (49660)	60/240-102 (561749)	
MT 732 / 932 Turbo Serie A			60/240-103 (563483)			
MT 830 / 840 / 930 CP Turbo, MT 930 / 1230 SCP Turbo MT 830 / 840 / 930 CP Turbo ULTRA, MT 930 / 1230 SCP Turbo ULTRA	60/161-207 (185578)	60/162-207 (484952)	60/97-3 (476954)		60/240-102 (561749)	
MT 830 / 840 / 930 CP, MT 930 / 1230 SCP MT 830 / 840 / 930 CP ULTRA, MT 930 / 1230 SCP ULTRA	60/161-208 (177130)	60/162-208 (177179)	60/97-2 (133755)			
MT 835 MONO-ULTRA						
MT 835 Turbo MONO-ULTRA	60/161-207 (185578)	60/162-207 (484952)				
MT 835-120 LS Serie 2	60/161-206 (563416)	60/162-206 (563415)	60/97-3 (476954)		60/240-102 (561749)	
MT 845 / 940 L (+ Turbo / Turbo MONO-ULTRA) Serie 2			60/97-2 (133755) Sans turbo Less Turbo			60/240-104 (221174)
			60/97-3 (476954) Avec turbo With Turbo			
MT 845 H / 940 H L Turbo Serie 1			60/97-3 (476954)			
MT 845 Serie 1, MT 940 L Serie 1	60/161-208 (177130)	60/162-208 (177179)	60/97-2 (133755)	60/240-102 (561749)		
MT 845 Turbo (+ MONO-ULTRA) Serie 1 MT 940 L Turbo (+ MONO-ULTRA) Serie 1	60/161-207 (185578)	60/162-207 (484952)	60/97-2 (133755)	60/240-104 (221174)		
MT 930 / 1235 CP 10°/10° ULTRA MT 930 / 1235 CPT 10°/10° ULTRA	60/161-208 (177130) CP	60/162-208 (177179) CP	60/97-2 (133755) CP			
	60/161-207 (185578) CPT	60/162-207 (484952) CPT	60/97-3 (476954) CPT			
MT 1230 SCP Serie C	60/161-208 (177130)	60/162-208 (177179)				
MT 1232 S Serie 1, MT 1240 L Serie 1	60/161-208 (177130)	60/162-208 (177179)	60/97-2 (133755)	60/240-102 (561749)		
MT 1232 S Turbo (+ MONO-ULTRA) Serie 1 MT 1240 L Turbo (+ MONO-ULTRA) Serie 1	60/161-207 (185578)	60/162-207 (484952)		60/240-104 (221174)		

Les références des pièces sont indicatives.
Nos pièces ne sont pas d'origine

"THE RELIABLE SERVICE"

Part numbers are quoted for reference purposes only.
Our parts and accessories are not original.

FILTRES FILTERS

Types d'engins Machines types	Air		Huile Oil	Combustible Fuel	Hydraulique Hydraulic
	Ext. / Out.	Int. / Inn.			
	1		2	3	4
MT 1233 / 1240 L (+ Turbo / Turbo MONO-ULTRA) Serie 2	60/161-206 (563416)	60/162-206 (563415)	60/97-2 (133755) Sans turbo Less Turbo 60/97-3 (476954) Avec turbo With Turbo	60/111-3 (49660)	60/240-102 (561749) 60/240-104 (221174)
MT 1235 CP 10°/10° MT 1235 CP 10°/10° Serie C	60/161-208 (177130)	60/162-208 (177179)	60/97-2 (133755)		
MT 1235 CP Turbo 10°/10°	60/161-207 (185578)	60/162-207 (484952)	60/97-3 (476954)		
MT 1330 / 1337 SL (+ Turbo / Turbo MONO-ULTRA) Serie 2	60/161-206 (563416)	60/162-206 (563415)	60/97-2 (133755) Less Turbo 60/97-3 (476954) With Turbo		60/240-102 (561749) 60/240-104 (221174)
MT 1330 / 1337 SL Serie 1	60/161-208 (177130)	60/162-208 (177179)	60/97-2 (133755)		
MT 1330 SL Turbo Serie 1 MT 1337 SL Turbo Serie 1 (+ Turbo MONO-ULTRA)	60/161-207 (185578)	60/162-207 (484952)			
MT 1332 H SL / 1637 H SL (+ Turbo / Turbo MONO-ULTRA) Serie 1	60/161-206 (563416)	60/162-206 (563415)	60/97-2 (133755) Sans turbo Less Turbo 60/97-3 (476954) Avec turbo With Turbo		
MT 1530 SCP Serie C	60/161-208 (177130)	60/162-208 (177179)	60/97-2 (133755)		
MT 1530 SCP Turbo ULTRA	60/161-207 (185578)	60/162-207 (484952)	60/97-3 (476954)		
MT 1530 SCP ULTRA	60/161-208 (177130)	60/162-208 (177179)	60/97-2 (133755)		
MT 1637 SL (+ Turbo / Turbo MONO-ULTRA) Serie 2	60/161-206 (563416)	60/162-206 (563415)	60/97-2 (133755) Sans turbo Less Turbo 60/97-3 (476954) Avec turbo With Turbo		60/240-102 (561749) 60/240-104 (221174)
MT 1637 SL Serie 1	60/161-208 (177130)	60/162-208 (177179)	60/97-2 (133755)		
MT 1637 SL Turbo Serie 1 (+ Turbo MONO-ULTRA)	60/161-207 (185578)	60/162-207 (484952)			
MVT 665 / 675			60/97-3 (476954)		
MVT Moteur 1004.4 - 1004.4T Sauf MVT 665 / 675			60/97-2 (133755)		
MVT Moteur 1004.4T - 1004.40T			60/97-3 (476954)		

Les références des pièces sont indicatives.
Nos pièces ne sont pas d'origine

"THE RELIABLE SERVICE"

Part numbers are quoted for reference purposes only.
Our parts and accessories are not original.

FILTRES
FILTERS

Types d'engins Machines types	Air		Huile Oil	Combustible Fuel	Hydraulique Hydraulic
	Ext. / Out.	Int. / Inn.			
	1		2	3	4
4RM25C IH BD154 Moteur / Engine			60/96-1 (49445)	60/111-3 (49660)	
4RM26N, 4RM30N IH D179 Moteur / Engine	60/161-209 (177129)				
4RM26NF Ford 2512 Moteur / Engine	60/161-208 (177130)		60/96-7 60/97-54		
4RM26NP, 4RM26NPE Perkins 4.236 Moteur / Engine			60/97-3 (476954) 60/97-2 (133755)		
4RM30HP, 4RE30HP, 4RE40HP Perkins 4.203 Moteur / Engine		60/161-209 (177129)			60/97-1 (106387)
4RM30HP, 4RE30HP, 4RE40HP, 4RE60H Perkins 4.236 Moteur / Engine	60/161-38 (169469)		60/97-3 (476954) 60/96-3 60/97-2 (133755)		
4RM35B, 4RM35C, 4RM36K, 4RM40B, 4RM40C, 4RM40K, 4RM50K IH D179 Moteur / Engine	60/161-208 (177130)				60/111-25
4RM35B, 4RM35C, 4RM36K, 4RM40B, 4RM40C, 4RM40K, 4RM50K IH D239 Moteur / Engine			60/97-39 (128680)	60/111-3 (49660)	
628T S3-E2 PS, 628-120 S3-E2 PS LSU, 630T B-E2, 634TB-E2 LSU, 630-120 B-E2 LSU, 634-120 B-E2 LSU, 634-120 B-E2 PS LSU MLT 7 Series 3 MLT7 Series B-E2				60/111-176 (605013)	
MLA Series 1 MLA Series 2 MLA Series 3-E2			60/97-97		60/240-147 (485696)

DIMENSIONS FILTRES FILTER SIZES

Dimensions filtres Filters sizes

Réf. Ref.	Ø x H L x l x H	Filet Thread	Réf. Ref.	Ø x H L x l x H	Filet Thread	Réf. Ref.	Ø x H L x l x H	Filet Thread
60/161-38	155 x 317	-	60/111-45	106 x 203	7/8-14	60/97-36	106 x 105	3/4-16
60/161-209	134 x 288	-	60/111-176	75 x 160	-	60/97-39	93 x 212	1-12 UNF
60/161-207	154 x 392	-	60/96-1	71 x 141	-	60/97-54	95 x 144	M22 x 1.5
60/161-208	155 x 308	-	60/96-2	65 x 115	-	60/97-56	93 x 117	3/4-16
60/161-206	163 x 347	-	60/96-3	71 x 156	-	60/97-97	97 x 150	2"-16
60/162-207	86 x 358	-	60/96-7	115 x 122	-	60/240-102	80 x 140	13/16"-16
60/162-208	105 x 282	-	60/96-14	95 x 116	-	60/240-103	69 x 175	-
60/162-206	88 x 333	-	60/97-1	76 x 142	3/4-16	60/240-104	70 x 200	-
60/111-3	84 x 73	-	60/97-2	93 x 143	3/4-16	60/240-105	69 x 242	-
60/111-25	85 x 157	M16 x 1.5	60/97-3	93 x 173	3/4-16	60/240-106	69 x 244	-
60/111-26	75.5 x 113.5	-	60/97-30	76 x 92	3/4-16	60/240-147	130 x 210	-

PRÉFILTRES PRE-CLEANERS





Réf. Ref.	Dimensions Sizes				Fig.
	D1	D2	H		
60/168-50	33/4"	96 mm	255 mm	278 mm	1
60/168-51	4"	102 mm	255 mm	278 mm	
60/168-52	4 1/2"	114 mm	255 mm	298 mm	
44/168-26 (489768)	3"	76mm	186mm	144mm	2

COUPE CIRCUITS
BATTERY ISOLATOR SWITCHES

Réf. Ref.	Entre-axe Dist. hole to hole	Description	Fig.
63/1885-2 (223594) 12-24V	35 mm	- 2 bornes M8 - 2 terminals M8	1
63/1885-1 12-24V		- 2 bornes M8 - 2 terminals M8	2
63/1885-8 (401172) ⇒ 48V - 150A	40 mm	- 2 bornes en cuivre M10 - 2 copper terminals M10	3



COSSES DE BATTERIE
BATTERY LEAD CONNECTIONS

Réf. Ref.	OEM	Câble Cable	Fig.
Modèle essence / Petrol model			
63/1740-9	485221 Positif / Positive +	35 mm ²	
63/1741-10	485222 Négatif / Negative -		
Modèle diesel / Diesel model			
63/1740-8	485223 Positif / Positive +	50 mm ²	
63/1741-8	485224 Négatif / Negative -		
Jeux de 2 cosSES / Kit of 2 battery connections			
63/1742-11 essence / petrol	485241 Positif + négatif	-	
63/1742-12 diesel / diesel	485242 Positif + négatif	-	

PRISES DE BATTERIES BATTERY PLUGS

Réf. Ref.	Remarques Comments	Amp.	Fig.
Section 16 mm² / Connection size 16mm²			
63/1970-17 (490394)	Prise mâle noire Black male plug	80A	1
63/1971-22 (490393)	Prise femelle noire Black female plug		2
63/1973-2 (582458)	Poignée Handle		3
Section 35 mm² / Connection size 35mm²			
63/1970-18 (453959)	Prise mâle noire Male socket black	160A	4
63/1971-23 (453958) (A)	Prise femelle noire Black female plug		5
Section 70 mm² / Connection size 70mm²			
63/1970-19 (454023)	Prise mâle noire Black male plug	320A	6
63/1971-24 (454024)	Prise femelle noire Black female plug		7
63/1973-3 (486356)	Poignée Handle		8
Connecteurs bi-polaires Section 50 mm² / 2 poles Connection size 50mm²			
63/1970-20 (419560)	Prise grise Grey plug	160A	9
63/1970-21 (5618T)		175A	10
63/1970-22 (473010)	Prise rouge Red plug		11
63/1970-23 (419491)	Prise grise Grey plug	350A	12
63/1973-4 (418601T)	Poignée Handle		13



(a) Poignée incorporée / Built-in handle

ROBINET DE RACCORDEMENT
CONNECTING DRAIN TAP

Réf. Ref.	Remarques Comments	Description
44/1743-1 (239479)	Positif / Positive + (rouge / red)	- Pour borne de batterie - Montage rapide pour cosses à œillets - Avec capuchon anti-sulfate
44/1743-2 (239478)	Négatif / Negative - (vert / green)	- For battery - Fast fitting for eyelet terminals - With protective cap



PROTÈGE BATTERIE
BATTERY PROTECTION







Réf. Ref.	Remarques Comments	Description
65/9604-401	520ml Aérosol	- Lubrifiant pour cosses et connexions - Lubrication for battery and other terminals



MANOCONTACT DE PRESSION D'HUILE
OIL PRESSURE SWITCH

Réf. Ref.	Description	Fig.
44/186-39	Moteurs IH, Perkins Engines	

INTERRUPTEURS SWITCHES

Réf. Ref.	Type Type	Encastrement Embedding	Commentaires Comments	Fig.
Boutons poussoirs plastiques / Plastic push switches				
63/950-81 (178924) 12-24V - 8A	push / push	Ø 22,2 mm	2 Bornes, connexion à vis 2 connectors, screw connection	
63/950-44 12-24V - 8A Rouge / Red				
Boutons poussoirs métalliques / Metal push switches				
63/2000-105 (573067) 12-24V - 25A	push / push	Ø 22,2 mm	2 Bornes, connexion à vis 2 connectors, screw connection	
63/950-82 12-24V - 25A Rouge / Red				
Interrupteurs à tirette / Pull switches				
63/1882-3 12-24V - 10A	2 positions	Ø 8,2 mm	2 Bornes, connexion à vis - épais. fixation 3 mm 2 connectors, screw connection Fitting thickness 3 mm	
63/1882-2			2 Bornes, connexion à vis - épais. fixation 10 mm 2 connectors, screw connection Fitting thickness 10 mm	
Interrupteurs à tirette lumineux / Luminous pull switches				
63/1882-7 12V - 10A Rouge / Red	2 positions	Ø 12,2 mm	2 Bornes, connexion par fiches plates 6,35 mm 2 connectors, plug connection 6,35 mm	
63/1882-8 12V - 10A Orange / Orange				
Commutateur de clignotant / Switch (flasher)				
63/1881-1 12-24V - 10A	3 positions	Ø 12,2 mm	3 Bornes, connexion à vis 3 connectors, screw connection	
Commutateurs à levier - noirs ou lumineux / Switch - black or with light				
63/1881-18 Noir / Black 12V - 20A	2 positions	Ø 12,2 mm	Noir - 2 fiches plates Black - 2 plug connection	
63/1881-19 Noir / Black 12V - 20A	3 positions		Noir - 3 fiches plates Black - 3 plug connection	
63/1881-20 Vert / Green 12V - 20A	2 positions		Connexion par 3 fiches plates 6,35mm. Lumineux. 3 plug 6,35 mm connection With light	
63/1881-21 Rouge / Red 12V - 20A				
63/1881-2 Orange / Orange 12V - 20A				

Les références des pièces sont indicatives.
Nos pièces ne sont pas d'origine

"THE RELIABLE SERVICE"

Part numbers are quoted for reference purposes only.
Our parts and accessories are not original.

COMMUTATEUR D'ÉCLAIRAGE COMBINED SWITCHES

Réf. Ref.	Description	Fig.
63/958-84 (162841)	Avec commande à poussoir pour avertisseur With horn	1
63/958-85 (191384)	Longueur du faisceau: 1100mm Cable length: 1100mm	2
63/958-86 (233919)	Longueur du faisceau: 500mm Cable length: 500mm	
63/958-87 (20001)	Double commande Double switch	3

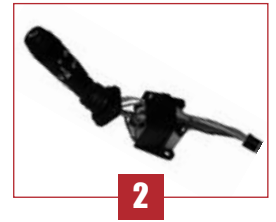
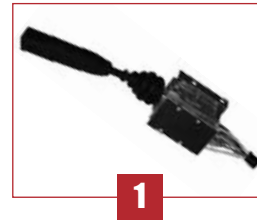

CONTACTEURS DE DÉMARRAGE STARTER SWITCHES

Réf. Ref.	Description	Fig.
63/950-89 (184817)	10 bornes 10 connectors	1
63/951-90 (184818)	Clé de rechange Replacement key	2
63/950-91 (58862)	5 bornes 5 connectors	3
63/951-20 (58863)	Clé de rechange Replacement key	4
63/950-93 (108511)	7 bornes 7 connectors	5
63/951-94 (49875)	Clé de rechange Replacement key	6

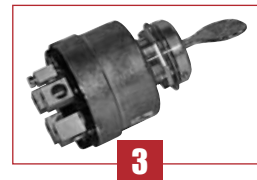

INVERSEURS DE MARCHÉ REVERSERS

Réf. Ref.	Description	Fig.
63/958-88 (234956)	Universel - Universal	1
63/958-89 (198069)	Gamme BTI et TMT BTI and TMT range	2



ALLUME-CIGARE CIGAR LIGHTER

Réf. Ref.	Fig.
44/1976-4 (485268)	

PRISE DE REMORQUE TRAILER PLUG

Réf. Ref.	Commentaires Comments	Description	Fig.
63/1971-2 (166347)	Métal Iron	Prise femelle Female socket	1
63/1970-2 (18992)		Fiche mâle Male socket	2



VIBREUR SONORE VIBRATOR

Réf. Ref.	OEM	Description	Fig.
63/1995-4	176737	12V - 65dB	

AVERTISSEURS HORNS

Réf. Ref.	Description	Fig.
Avertisseur de route / Horn		
63/1995-5 (20125) 12V	107dB	

Réf. Ref.	Description	Fig.
Avertisseur de recul / Reversing horn		
63/1995-3 (76925) 12V-24V	91dB	

FEU DE RECUL REVERSING LIGHT

Réf. Ref.	OEM	Description	Fig.	Types d'engins Machines types
44/1931-46	236148	Feu de recul / Reversing light		MSI20, MSI20D, MSI25, MSI25D, MSI30, MSI30D
63/1955-382		Ampoule / Bulb 12V/21W		

Les références des pièces sont indicatives.
Nos pièces ne sont pas d'origine

"THE RELIABLE SERVICE"

Part numbers are quoted for reference purposes only.
Our parts and accessories are not original.

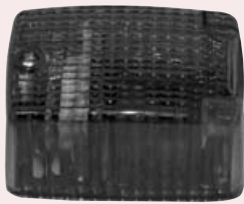

FEUX CLIGNOTANT
INDICATOR

Réf. Ref.	OEM	Description	Fig.	Types d'engins Machines types
44/1918-116 63/1955-382	1752	Ø 75 mm Ampoule / Bulb 12V/21W		MLT523, MLT524, MLT526, MLT527, MLT628, MLT632, MLT632T
44/1918-140 44/1918-141 44/1919-82 63/1955-382	551322 551814	Droit / Right Gauche / Left Dim.90 x 60 x 55 mm Cabochon / glass Ampoule / Bulb 12V/21W		Série MT series

FEUX ARRIÈRE
REAR LIGHTS

Réf. Ref.	OEM	Description	Fig.	Types d'engins Machines types
44/1912-210 44/1912-211	163783 163782	Droit / Right Gauche / Left Dim. 160 x 60 x 50 mm		MCE, MCL, MC...CP, M2, M4
44/1913-191 44/1913-192 63/1955-382 63/1955-500	165598 165599	Cabochon droit / Right glass Cabochon gauche / Left glass Ampoule / Bulb 12V/21W Ampoule / Bulb 12V/5W		
44/1912-178 44/1913-173 63/1955-382 63/1955-207	661973 564744	Droit et gauche / Rear right and left Lg. 350 mm Cabochon / Glass Ampoule / Bulb 12V/21W Ampoule / Bulb 12V/10W		MLT629, MLT633, MLT634, MLT734, MLT730, MLT731 MT732, MT932, MT835, MT845, MT940, MT1233, MT1240, MT1330, MT1332, MT1337, MT1637
44/1912-201 44/1913-172 63/1955-382 63/1955-239	2163 1371	Droit et gauche / Right and left Dim. 145 x 105 x 60 mm Cabochon / Glass Ampoule / Bulb 12V/21W Ampoule / Bulb 12V/5W		
44/1912-212 44/1912-213 63/1955-500 63/1955-382	587421 587422 163825	Droit / Right Gauche / Left Dim. 190 x 105 x 60 mm Ampoule / Bulb 12V/5W Ampoule / Bulb 12V/21W		MRT1850

PHARES AVANT FRONT LIGHTS

Réf. Ref.	OEM	Description	Fig.	Types d'engins Machines types
44/181-73 63/1955-410 63/1955-250	20997	Ø 140 mm Ampoule / Bulb 12V/45-40W Ampoule / Bulb 12V/2W		
44/181-68 63/1955-615 63/1955-250	189007 189008R	Optique de phare (cond. à droite) Front light (Right dip) Ampoule / Bulb 12V/45-40W Ampoule / Bulb 12V/3W		MLT523, MLT524, MLT526, MLT527, MLT628, MLT632, MLT728, MLT928
44/181-72 63/1955-615 63/1955-250	189008	Optique de phare (cond. à gauche) Front light (Left dip) Ampoule / Bulb 12V/45-40W Ampoule / Bulb 12V/3W		

PHARES DE TRAVAIL WORKLAMP

Réf. Ref.	OEM	Description	Fig.
44/1931-53 63/1955-453 63/1955-460	874	Ø 150 mm Ampoule / Bulb 12V/55W Ampoule / Bulb 24V/70W	
44/1931-54 63/1955-448	466212	Dim. 100 x 150 mm Ampoule / Bulb 12V/55W	
44/1931-55 63/1955-453 63/1955-460	223480	Dim. 70 x 140 mm Ampoule / Bulb 12V/55W Ampoule / Bulb 24V/70W	

Les références des pièces sont indicatives.
Nos pièces ne sont pas d'origine

"THE RELIABLE SERVICE"

Part numbers are quoted for reference purposes only.
Our parts and accessories are not original.

PHARES DE TRAVAIL
WORKLAMP

Réf. Ref.	OEM	Description	Fig.
44/1931-56	582075	Dim. 85 x 160 mm	
44/1924-2	508118	Grille de protection Protection grille	
63/1955-453		Ampoule / Bulb 12V/55W	
63/1931-35	223595	Avant droit et arrière gauche Front right and rear left	
63/1931-34	223596	Avant gauche et arrière droit Front left and rear right	
63/1955-453		Dim. 90 x 150 mm Ampoule / Bulb 12V/55W Série MLT, MT series	
44/1931-91	224580	Avant droit et arrière gauche Front right and rear left	
44/1931-92	224581	Avant gauche et arrière droit Front left and rear right	
63/1955-453		Ampoule / Bulb 12V/55W	
63/1955-250		Ampoule / Bulb 12V/4W	
63/1955-287		Ampoule / Bulb 12V/55W	
63/1955-501		Ampoule / Bulb 12V/21W Série MLT, MT series	

EMBAYAGES CLUTCH



44/200-172



44/200-173

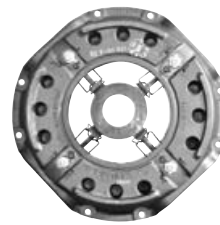

44/200-174

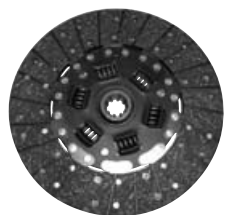

44/221-240

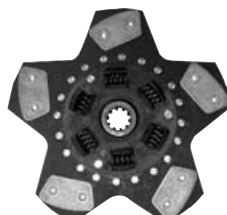

44/221-241

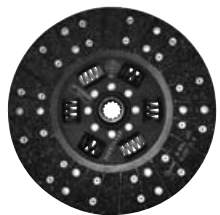

44/221-242

Types d'engins Machines types	Réf. kit Kit ref.	Mécanisme Clutch assy	Disque Disc	Butée Release plate	Rit de volant Flywheel bearing
MB20C, MB20CL, MB25C, MB30C, 4RM20C, 4RM25C, MC20C, MC25C, MC30C, MCE20C, MCE20H, MCE25C, MCE25H, MCE30C, MCE30H, MC40C, MB21C, MB26C	44/200-1450KT	44/200-172 (33479) 11" 280mm centreur centring ring 12mm	44/221-240 (49319) UF 10Z - 23x29	44/231-172 (49022)	44/230-172 (49532)
	44/200-1451KT centreur centring ring 6mm	44/200-173 11" 280mm centreur centring ring 6mm	44/221-241 (AAU2906) LS 10Z - 23x29		
Manitool	44/200-1452KT	44/200-174 280mm	44/221-242 TF 13Z - 21.7x25	44/231-174 Carbonne Carbon	

UF: Organique fixe / Fixed organic

TF: Organique à ressorts / Spring organic

LS: 5 paires de pastilles / 5 pairs of pads

TRANSMISSION
TRANSMISSION

Types d'engins Machines types	Cardan renforcé Heavy duty propeller	Croisillon Universal joint
	1	2
M-MT-MLA-MLT-MRT-MVT	44/5000-110 (224734bis)	44/6403-111 (505556) 30.2 x 83mm
		44/6403-112 (109753) 30.1 x 106.3mm



1

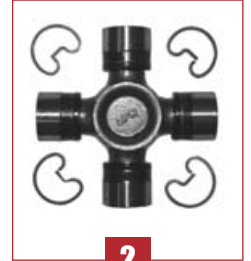

2

TRANSMISSION MULTIDISQUES
MULTI-PLATES TRANSMISSION



1



2-1



2-2



3



4

Types d'engins Machines types	Pompe de transmission Transmission pump	Disque intermédiaire Intermediate disc	Disque de friction Friction disc	Plat. intermédiaire Intermediate plate
	1	2	3	4
Suivant montage embrayage Some clutch fitting	44/566-352 (136353)	44/316-25 (2-1) (106375) 54Z	44/317-21 (449376) 118 x 68.2 x 2.2mm 33Z	44/316-23 (449375) 129 x 76 x 1.5mm
		44/316-22 (2-2) (109594) 139 x 98.5 x 1.8mm 50Z		

MAÎTRE CYLINDRE DE FREIN
MASTER BRAKE CYLINDER

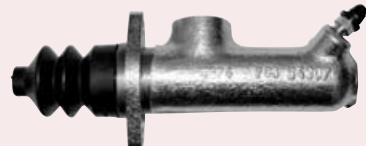
Types d'engins Machines types	Réf. Ref.	OEM	Description
MLT523, MLT524, MLT526, MLT527, MT727, MT728, MT927, MT928 MC30, MC40, MC50, MC60 (CP) M2 26CP, M2 30CP M4 26CP, M4 30CP	44/410-49	199624	

FREINS À DISQUE (BAIN D'HUILE) OIL BATH DISC BRAKES

Réf. Ref.	OEM	Dimension		Fig.
44/422-38	475796	177.9 x 34 x 4.8	19Z	1
44/422-39	477709	199.6 x 129.6 x 2.7	-	2
44/422-40	478031	97.6 x 84.8 x 1.5	-	3
44/422-41	478128	142.9 x 34 x 4.9	19Z	4
44/422-43	549314	169.6 x 56.2 x 4.8	28Z	5
44/422-42	549313	170 x 109.75 x 2.6	-	6
44/423-16	477279	201.6 x 130 x 2.7	-	7
44/423-17	133989	209.3 x 121 x 2.7	-	8
44/423-18	501266	162.9 x 80 x 2.7	-	9
44/423-19	562516	201 x 40.6 x 4.8	16Z	10
44/422-70	473832	215 x 10	15Z	11
44/416-37	473835	Ext. / Out.	Joint / Seal	12
44/416-38	473838	Int. / Inn.		
44/416-39	473837	Ext. nylon Out.		
44/416-40	473834	Int. nylon Inn.		
44/416-43	549253			-
44/416-44	549322			-

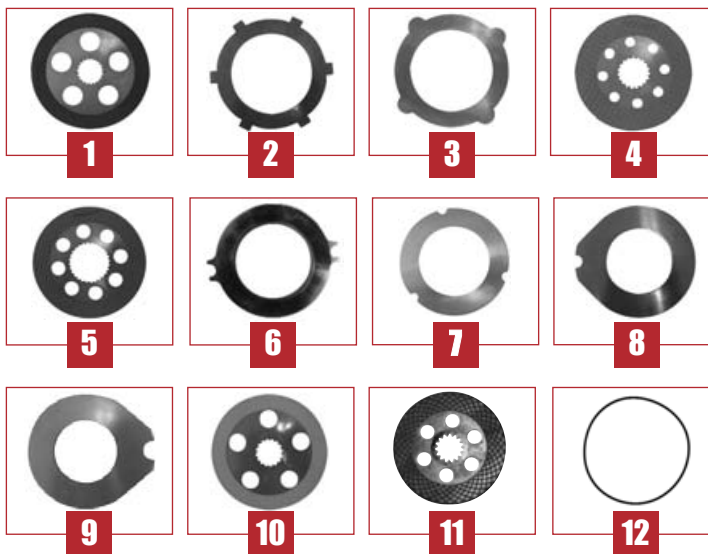

FREINS À DISQUE (SEC) DRY DISC BRAKES



Types d'engins Machines types	Mécanisme Mechanism	Disque Disc	Bille Ball	Ressort Spring	Soufflet Below
	1	2	3	4	5
MB20C, MB20CL, MB25C, MB30C, 4RM20C, 4RM25C, MC20C, MC25C, MC30C, MCE20C, MCE20H, MCE25C, MCE25H, MCE30C, MCE30H, MC40C, MB21C, MB26C	44/417-90 (49250)	44/420-90 (49023) 10Z 44/435-90 23Z	44/418-90 (49064)	44/419-90 (49196)	44/424-90 (49183)

FREINS À MAINS HAND BRAKES

Réf. Ref.	OEM	Description	Fig.
44/432-3	49329	Avec cran de sécurité With safety notch	1
44/432-4	225199		
44/7703-7	564765	Plaquettes de frein Disc brake pads	2



CARTER DE MOYEU (MONTAGE CARRARO)
HUB HOUSING (CARRARO FITTING)

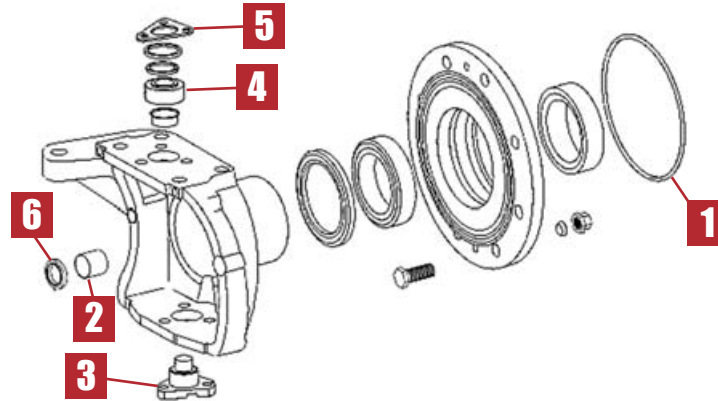

Types d'engins Machines types	Anneau Ring	Bague Bush	Pivot Pin	Bague Bush	Épaisseur Thickness	Bague Bush
	1	2	3	4	5	6
Montage Carraro	44/6413-123	44/6462-123 35 x 39 x 35	44/6450-123 ↑ (475270) Ø 36 - 50	44/6452-123 sup. type Belleville Upper Belleville type	44/6453-123 (108916) 0.35mm	44/6407-67 42.2 x 46.2 x 31.7
		44/6462-124 45 x 50 x 35	44/6450-124 ↓ (109533) Ø 28 - 50	44/6452-124 inf. type Belleville Lower Belleville type	44/6453-124 (108915) 0.19mm 44/6453-125 (108914) 0.10mm	44/6407-68 42 x 46 x 32

BAGUES D'ÉTANCHÉITÉS DIVERSES
COVER SEAL

Réf. Ref.	OEM	Dimensions Sizes
44/6408-37	108948	35 x 52 x 16
44/6408-38	108965	42 x 62 x 14
44/6408-39	549259	45 x 65 x 12
44/6408-54	R4485	50 x 65 x 8
44/6408-40	108100	55 x 80 x 11
44/6408-41	473892	58 x 82 x 15
44/6408-42	107349	60.3 x 79.37 x 9.5/10.5
44/6408-43	549339	70 x 100 x 10
44/6408-44	473868	75 x 102 x 14
44/6408-45	473671	136.8 x 165 x 13
44/6408-55	604656	140 x 170 x 14.5/16
44/6408-46	475393	149.9 x 176 x 16
44/6408-47	109555	155 x 176 x 16
44/6408-48	501058	165 x 195 x 11.5



ROTULES ET TIRANTS DE DIRECTION 4RM TIE ROD AND SOCKETS 4WD



1



4



3



2

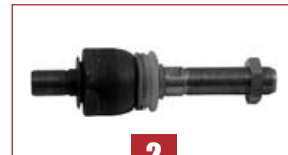

2



5



6



7

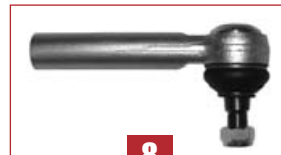

8

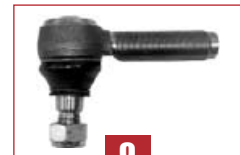

9

Réf. Ref.	OEM	Filet Thread	Longueur Length	 (mm)	Fig.
44/490-23	601216	M 22 x 1.5 RH	435	27 x 30	1
44/497-179	601209	M 24 x 1.5 RH / M 22 x 1.5 RH	210	-	2
44/495-172	601218	F 24 x 1.5 RH	294	27 x 30	3
44/490-24	601217	M 22 x 1.5 RH	435	27 x 30	4
44/497-179	601209	M 24 x 1.5 RH / M 22 x 1.5 RH	210	-	2
44/496-52	601219	F 24 x 1.5 RH	294	27 x 30	5
44/490-25	601222	M 22 x 1.5 RH	500	27 x 30	1
44/497-179	601209	M 24 x 1.5 RH / M 22 x 1.5 RH	210	-	2
44/495-173	601220	F 24 x 1.5 RH	359	27 x 30	3
44/490-26	601221	M 22 x 1.5 RH	500	27 x 30	4
44/497-179	601209	M 24 x 1.5 RH / M 22 x 1.5 RH	210	-	2
44/496-53	601223	F 24 x 1.5 RH	359	27 x 30	5
44/490-27	601212	M 22 x 1.5 RH	540	27 x 30	1
44/497-179	601209	M 24 x 1.5 RH / M 22 x 1.5 RH	210	-	2
44/495-174	601214	F 24 x 1.5 RH	397	27 x 30	3
44/490-28	601213	M 22 x 1.5 RH	540	27 x 30	4
44/497-179	601209	M 24 x 1.5 RH / M 22 x 1.5 RH	210	-	2
44/496-54	601215	F 24 x 1.5 RH	397	27 x 30	5
44/490-29	601207	M 22 x 1.5 RH	475	27 x 30	1
44/497-179	601209	M 24 x 1.5 RH / M 22 x 1.5 RH	210	-	2
44/495-175	601210	F 24 x 1.5 RH	335	27 x 30	3
44/490-30	601208	M 22 x 1.5 RH	475	27 x 30	4
44/497-179	601209	M 24 x 1.5 RH / M 22 x 1.5 RH	210	-	2
44/496-55	601211	F 24 x 1.5 RH	335	27 x 30	5

Les références des pièces sont indicatives.
Nos pièces ne sont pas d'origine

"THE RELIABLE SERVICE"

Part numbers are quoted for reference purposes only.
Our parts and accessories are not original.

ROTULES ET TIRANTS DE DIRECTION 4RM
TIE ROD AND SOCKETS 4WD

Réf. Ref.	OEM	Filet Thread	Longueur Length	 (mm)	Fig.
44/490-31	477796	M 30 x 1.5 RH	455	29 x 32	6
44/497-181	661500	M 28 x 1.5 RH / M30 x 1.5 RH	245	-	2
44/495-181	661501	F 28 x 1.5 RH	315	29 x 32	7
44/497-179	601209	M 24 x 1.5 RH / M 22 x 1.5 RH	210	-	2
44/495-238	561557	F 24 x 1.5 LH	165	23.5 x 26	8
44/497-179	601209	M 24 x 1.5 RH / M 22 x 1.5 RH	210	-	2
44/495-171	474683	F 24 x 1.5 RH	255	27 x 30	8
44/497-270		M24 x 1.5 LH / M22 x 1.5 RH	210	-	2
44/497-179	601209	M 24 x 1.5 RH / M 22 x 1.5 RH	210	-	2
44/495-270	-	F24 x 1.5 LH	204	23.5 x 26	8
44/495-271		F24 x 1.5 RH	204	23.5 x 26	8
44/495-272	108991	M24x1,5 RH	106	18 x 20	9
44/495-273	420189	M24x1,5 LH	106	18 x 20	9
44/495-236	6060	M 22 x 1.5 LH	100	18 x 20	9
44/495-237	6063	M 22 x 1.5 RH	100	18 x 20	9

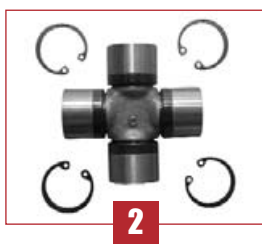
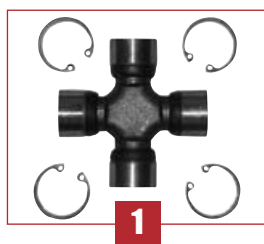
CROISILLONS
UNIVERSAL JOINT

Types d'engins Machines types	Réf. Ref.	Description	Fig.
Modèles divers Various models	44/6403-106	27 x 82mm	1
	44/6403-107	27 x 73mm	2
	44/6403-108	27 x 75mm	3

POMPES HYDRAULIQUES HYDRAULIC PUMPS

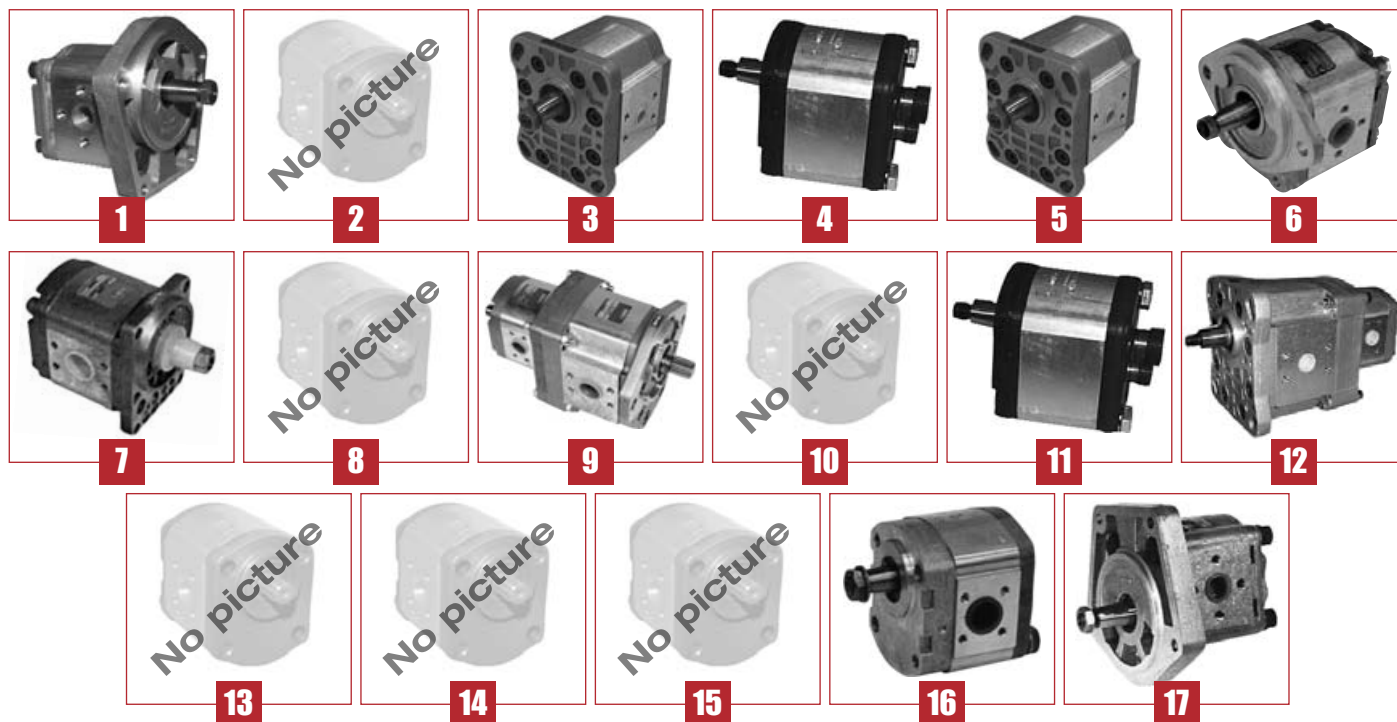

Types d'engins Machines types	Réf. Ref.	Description	Fig.
MB20C, MB20CL, MB25C, MB30C, 4RM20C, 4RM25C, MC20C, MC25C, MC30C, MCE20C, MCE20H, MCE25C, MCE25H, MCE30C, MCE30H, MC40C, MB21C, MB26C, MB2500H Moteur / Engine BD154	44/566-329	Pompe simple / Single pump	1
MB20SA	44/566-306	Pompe double groupe 3 / Tandem pump Group 3	2
MB20C, MB25F, MB30G	44/566-307 (25237, 173284, 176797)	Pompe principale / Principal pump	3
MC15, MB20, MB20SM, MC6, MC20, MC20E, MC25, MC25A	44/566-308	Pompe auxiliaire avec kit modif. Auxiliary pump delivered with modif. kit	4
MB21C, MB21J, MB30J, MC40TC, M26NF	44/566-309 (53840)	Pompe principale / Principal pump	5
MC50SC, MT425C, MB30	44/566-310 (24456)	Pompe de direction / Steering pump	6
MC15A, MC18A, MC20, MT20, Buggy	44/566-311	Pompe de levage / Lifting pump	7
MC15A, MC18A, MC20, MT20		Pompe simple / Single pump	7
MCL30H, MCE25H, MC20H	44/566-312	Pompe double avec kit de modification Double pump with modification set	8
MCE30H, MCE25H, MCL25H, MCL30	44/566-313	Pompe double de levage + direction Double lifting & steering pump	9
MC40C, MB60C	44/566-314	Pompe de levage / Lifting pump	10
MC55, MC55H	44/566-315	Pompe simple / Single pump	11
MT425CP, 425SP, MLT425, MT431CP	44/566-316	Pompe de levage + direction / Lifting pump + Steering pump	12
MLT526, MLT626, MLT630, MLT725	44/566-317 (197297)	Pompe triple / Triple pump	13
MT430CPS	44/566-318	Pompe de levage + direction / Lifting pump + Steering pump	14
4RE25RH	44/566-319	Pompe de levage + direction / Lifting pump + Steering pump	15
BS423, 35C	44/566-320	Pompe de direction / Steering pump	16

Les références des pièces sont indicatives.
Nos pièces ne sont pas d'origine

"THE RELIABLE SERVICE"

Part numbers are quoted for reference purposes only.
Our parts and accessories are not original.

POMPES HYDRAULIQUES
HYDRAULIC PUMPS

Types d'engins Machines types	Réf. Ref.	Description	Fig.
MB20C, MB25C, MB30C, 20C4RM, 25C4RM, MB2500H	44/566-321 (49054)	Pompe de direction / Steering pump	17
MB20	44/566-322	Pompe à piston / Piston pump	18
MB20C, MB21C, MB30J, MB30A, MB30	44/566-323	Pompe de levage / Lifting pump	19
MB30C	44/566-324	Pompe simple / Single pump	20
MT425CP, 425SP, MLT425, MT431CP	44/566-316 (75998, 177896)	Pompe de levage + direction / Lifting pump + Steering pump	12
626MLT	44/566-325 (8779)	Pompe double / Double pump	21
	44/566-326 (928)	Pompe simple / Single pump	22
M40CP	44/566-327	Pompe double / Double pump	23
MC50EC	44/566-328	Pompe simple / Single pump	24
526, 630, 626, 725, MC40TC, M26NF	44/566-317 (197297)	Pompe triple / Triple pump	13
MCE20, MCE25H, MCE25HZ	44/566-330	Pompe hydraulique / Hydraulic pump	25
MB60	44/566-331	Pompe hydraulique / Hydraulic pump	26
MC80F, MC100	44/566-332	Pompe hydraulique / Hydraulic pump	27
CPH250	44/566-333	Pompe hydraulique / Hydraulic pump	28
MT1425CP	44/566-334	Pompe hydraulique / Hydraulic pump	29
727	44/566-335	Pompe hydraulique / Hydraulic pump	30
MLT728	44/566-336	Pompe hydraulique / Hydraulic pump	31
MLT728	44/566-337 (6783, 212846)	Pompe hydraulique / Hydraulic pump	32
MB25	44/566-338	Pompe hydraulique / Hydraulic pump	33

Les références des pièces sont indicatives.
Nos pièces ne sont pas d'origine

"THE RELIABLE SERVICE"

Part numbers are quoted for reference purposes only.
Our parts and accessories are not original.

ALTERNATEURS ALTERNATORS

Réf. Ref.	Applications Applications	OEM	Ø1 	Ø2
62/920-4 14V / 55A	Perkins 4.248 2 - 4.236 - 4.236T - 1004.4 - 1004.4T	217366, 23737R, 23962R	 ↻	 ↻
62/920-10 14V / 65A	Perkins		 ↻	 ↻
62/920-108 14V / 70A			2871A141, 2871A163	 ↻

DÉMARREURS STARTERS

Réf. Ref.	OEM	A x B 	Z 	L
62/930-38 12V / 2.8kW	561414, 109281, 2873B056, 2873B071	3x127 	10z	237
62/930-80 12V / 2.8kW	2873B072	3x127 	10z	238
62/930-5 12V / 3.5kW				254

Autres types, nous consulter
Other types, contact us

FLEXIBLES ET RACCORDS
FLEXIBLES AND COUPLINGS

Types d'engins Machines types	Réf. Ref.	OEM
Chariot élévateur à Mat Handlers	69/9448-1	Flexible Jumelé 1/2" - 2 Tresses 2 nappes 1/2" Twin hoses

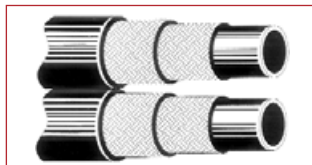

Réf. Ref.	Filet Thread	Ø tube Ø tube	Flex	L. mm
69/9068-1	M26 x 1.5	16	1/2"	115
69/9068-2	M24 x 1.5	16	1/2"	180
69/9068-3	M30 x 2	20	1/2"	115



COUPLEURS RAPIDE
QUICK COUPLINGS

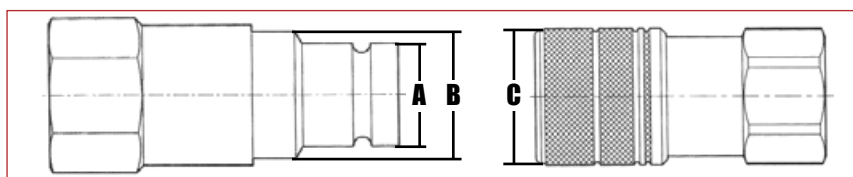

Réf. mâle Male ref.	Réf. femelle Female ref.	Filet Thread	Corp Body	Bar Bar	A mm	B mm	C mm
Coupleurs face plate / Flat faced coupling							
69/9471-2	69/9472-2	3/8 BSP	3/8	250	19.8	23.9	32.7
69/9471-3	69/9472-3	3/8 BSP					30.00
69/9471-5	69/9472-5	1/2 BSP	3/8	250	19.8	23.9	32.7
69/9471-6	69/9472-6	1/2 BSP					30.00
69/9471-7	69/9472-7	M16 x 1.5	3/8	350	19.8	23.9	32.7
69/9471-8	69/9472-8	1/2 BSP	1/2	200	24.5	30.4	37.7
69/9471-9	69/9472-9	1/2 BSP					40.00
69/9471-15	69/9472-15	3/4 BSP	3/4	200	30.0	38.7	47.4

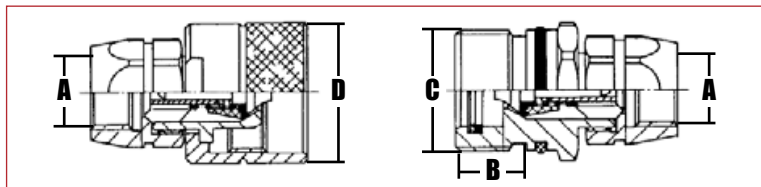

Réf. mâle Male ref.	Réf. femelle Female ref.	A	Bar Bar	B mm	C mm	D mm
Coupleurs rapide à visser / Quick coupling to screw						
69/9465-2	69/9466-2	3/8 BSP	450	17	M28x2,0	34
69/9465-5	69/9466-5	1/2 BSP	400	22	M36x2,0	42
69/9465-8	69/9466-8	M22x1,5	300	28	M42x2,0	48
69/9465-10	69/9466-10	3/4 BSP	300	35	M48x3,0	55
69/9465-11	69/9466-11	1 BSP	300	35	M48x3,0	55

Les références des pièces sont indicatives.
Nos pièces ne sont pas d'origine

"THE RELIABLE SERVICE"

Part numbers are quoted for reference purposes only.
Our parts and accessories are not original.

BOUCHONS POUR COUPLEURS CAPS FOR FLAT FACED

Réf. Ref.	Ø mm
Face plate mâle / Male flat faced	
69/9496-1	19.8
69/9496-2	24.5
69/9496-3	30.0
Face plate femelle / Female flat faced	
69/9496-10	32.7
69/9496-11	37.7
69/9496-12	47.4

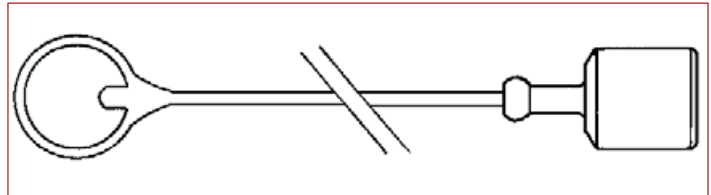

Réf. Ref.	Ø mm
Bouchon à visser pour coupleur mâle Schäffer (Manitou) Caps to screw for male quick coupling	
69/9483-1	M36 x 2,0
69/9483-2	M42 x 2,0
69/9483-3	M48 x 2,0
Bouchon à visser pour coupleur femelle Schäffer (Manitou) Caps to screw for female quick coupling	
69/9483-10	M36 x 2,0
69/9483-11	M42 x 2,0
69/9483-12	M48 x 2,0



Réf. Ref.	Type
O-ring + bague de conduction + bague de support O-ring + conduction ring + support ring	
69/9490-30	06
69/9490-31	08
69/9490-32	12
69/9490-33	16



VALVE DE SÉCURITÉ SECURITY VALVE

Types d'engins Machines types	Réf. Ref.	OEM	Description
Tous types équipés Fits all types	69/7639-2	238131	Valve sur vérins "Oil Control" Cylinder valve



Les références des pièces sont indicatives.
Nos pièces ne sont pas d'origine

"THE RELIABLE SERVICE"

Part numbers are quoted for reference purposes only.
Our parts and accessories are not original.

ACCESSOIRES POUR LAVE-GLACE WINDSHIELD WASHER ACCESSORIES

Réf. Ref.	OEM	Description	Fig.
44/1989-2	573046	Gicleur Nozzle	1
44/1989-4	199955	Passer cloison Elbow connector	2
44/1989-5	551450	Réservoir / Containers Pompe / Pump 12V	3
44/1989-3	564916	Réservoir / Containers Pompe / Pump 12V	4
44/1989-6	199956	2x Gicleur / 2 nozzles 1x Raccord / Adapter < I > 2x Raccord / Adapter < T > Tuyau caoutchouc ± 3m / Rubber pipe ± 3m Câblage / Wiring	-



BALAI D'ESSUIE-GLACE WIPER BLADES

Réf. Ref.	OEM	Longueur Length	Type de fixation Fixation type	Adaptable sur les bras... Fitted on the arms...	Fig.
70/1987-68	89135	300 mm	A	63/0913, 44/1985-5, 44/1985-6	
70/1987-63	182819	330 mm	A		
70/1987-64	54557, 551841	400 mm	A		
70/1987-65	72431	450 mm	A		
70/1987-6	573214, 85282	500 mm	A, B	63/0913, 44/1985-5, 44/1985-6	
70/1987-600	2802315MI	600 mm	Universel	63/0913, 44/1985-5, 44/1985-6, 44/1985-7	
70/1987-7	573113, 167787		A	63/0913, 44/1985-5, 44/1985-6	
70/1987-38	551874		B		
70/1987-30	193155	700 mm	B		
70/1987-66	691723, 198290	800 mm	B		

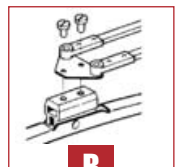
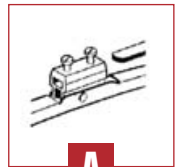

BRAS D'ESSUIE-GLACE WIPER ARM

Réf. Ref.	OEM	Longueur (mm) Length (mm)	Section (mm) Ø (mm)	Fig.
44/1985-17	89136, 6310913	300-400	8 x 3.0 - Ø 6mm	
44/1985-5	198127	300-400	8 x 3.0 - A8	
44/1985-6	184526, 551563, 573213	400-500	8 x 3.0 - A8	
44/1985-7	600737	400-500	7.1 x 2.5 - A8	
44/1985-4	175201, 573117	400-500	8 x 3.0	

Les références des pièces sont indicatives.
Nos pièces ne sont pas d'origine

"THE RELIABLE SERVICE"

Part numbers are quoted for reference purposes only.
Our parts and accessories are not original.

MOTEURS D'ESSUIE-GLACE WIPER MOTORS



1



2



3

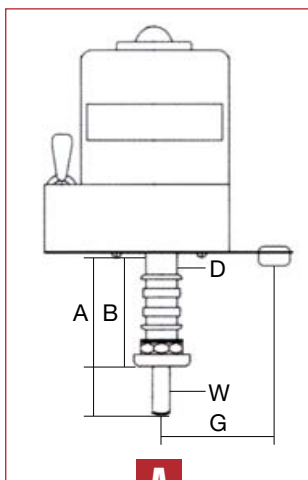

A

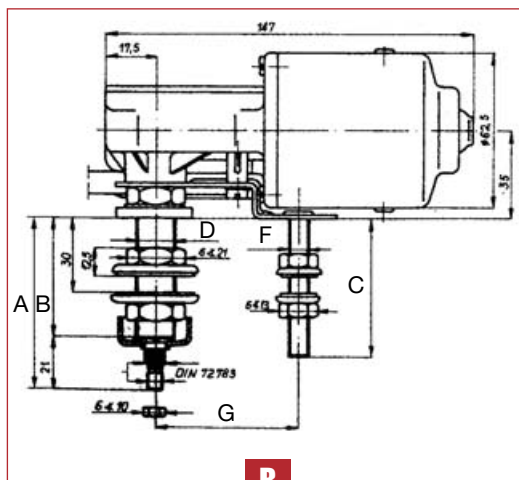

B

Réf. Ref.		Volt.	Rotation Rotation		Vitesse Speed	A (mm)	B (mm)	C (mm)	D	F	G (mm)	W (Ømm)	Type Type	Fig.
44/1980-70 (473390)	85°	12	-	-	1	61	46	-	M10 x 1	-	-	6	A	1
44/1980-85 (198126)	85°	12	-	-	1	115	99	-	M10 x 1	-	45	6	A	
44/1980-33 (202659, 610092)	85°	12	-	-	1	67	42	-	M12 x 1	-	45	A8 x M6	A	2
44/1980-71 (573070)	85°	12	-	-	1	119	94	-	M12 x 1	-	45	A8 x M6	A	
44/1980-34 (175856)	80°	12	G. - LH.	v	1	79	58	55	M12 x 1	M8	50 ⇔ 57	A8 x M6	B	3
44/1980-72 (199414, 208889)	80°	12	G. - LH.	-	1	79	58	55	M16 x 1	M8	50 ⇔ 57	A8 x M6	B	
44/1980-73 (551330, 562054)	80°	12	D. - RH.	-	1	69	48	50	M16 x 1	M8	50 ⇔ 57	A8 x M6	B	
44/1980-74 (551567)	80°	12	D. - RH.	-	1	69	48	35	M16 x 1	M8	50 ⇔ 57	A8 x M6	B	
44/1980-35 (454542)	80°	24	G. - LH.	v	1	79	58	55	M12 x 1	M8	50 ⇔ 57	A8 x M6	B	
44/1980-36 (573050)	90°	12	G. - LH.	v	1	79	58	55	M12 x 1	M8	50 ⇔ 57	A8 x M6	B	
44/1980-37 (573125, 573199)	90°	24	G. - LH.	v	1	79	58	55	M12 x 1	M8	50 ⇔ 57	A8 x M6	B	
44/1980-38 (205243, 54556)	110°	12	G. - LH.	v	1	79	58	55	M12 x 1	M8	50 ⇔ 57	A8 x M6	B	
44/1980-75 (552760)	110°	12	G. - LH.	-	1	79	58	55	M12 x 1	M8	50 ⇔ 57	A8 x M6	B	
44/1980-76 (631TH87)	110°	24	G. - LH.	v	1	79	58	55	M12 x 1	M8	50 ⇔ 57	A8 x M6	B	

Les références des pièces sont indicatives.
Nos pièces ne sont pas d'origine

"THE RELIABLE SERVICE"

Part numbers are quoted for reference purposes only.
Our parts and accessories are not original.

MOTEURS D'ESSUIE-GLACE
WIPER MOTORS

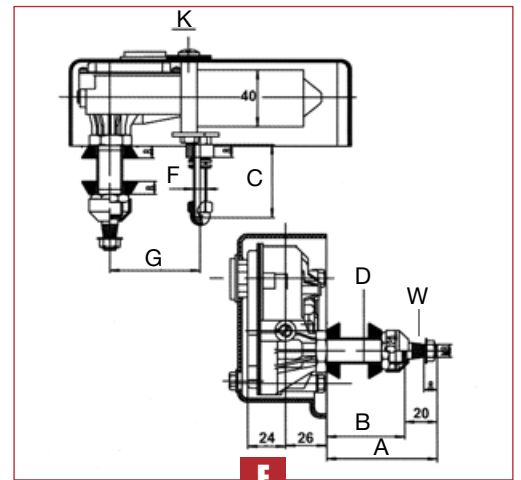
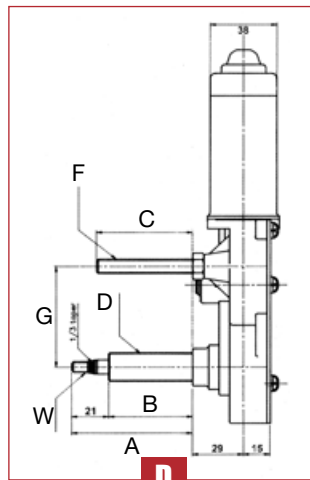
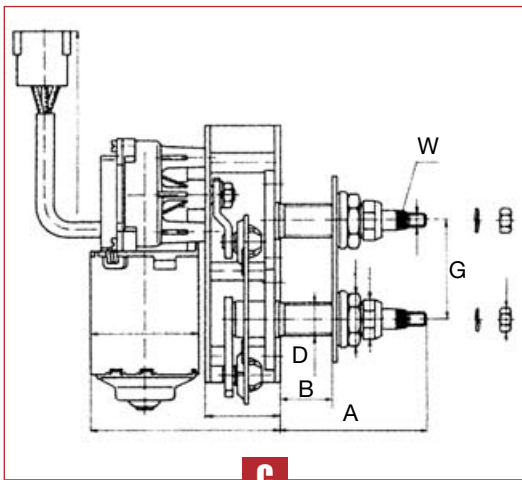
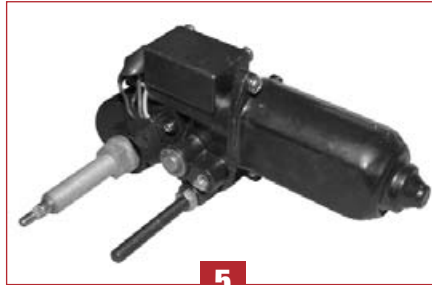
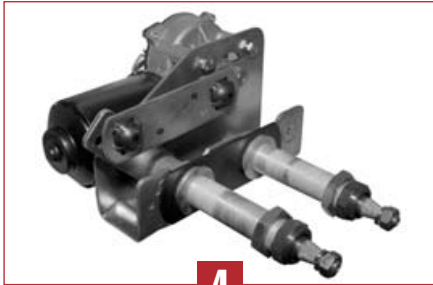

Réf. Ref.		Volt.	Rotation Rotation		Vitesse Speed	A (mm)	B (mm)	C (mm)	D	F	G (mm)	W (8mm)	Type Type	Fig.
44/1980-39 (199412)	80°	12	G. - LH.	-	1	80	30	-	M20 x 1	-	60	A12 x M8	C	4
44/1980-40 (545534)	70°	24	G. - LH.	-	2	110	60	-	M20 x 1	-	60	A12 x M8	C	
44/1980-32 (610075, 174055)	85°	12	G. - LH.	-	2	69	48	55	M14	M8	57	A8 x M6	D	5
44/1980-31 (563841)	85°	12	G. - LH.	-	1	53	33	16	M16 x 1	M8	57	A10 x M8	E	6

CLIMATISATION
AIR-CONDITIONING









Types d'engins Machines types	Réf. Ref.	Description	Fig.
Modèles divers Various models	82/9202-453	Filtre déshydrateur Driers	

VÉRINS À GAZ GAS STRUTS

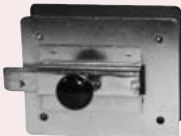

Types d'engins Machines types	Capot moteur Engine bonnet	Capot réservoir Tank bonnet	Glace arrière Rear window
MC40, MC50 (POWERSHIFT) Séries 1 & 2 Series MC60, MC70 (TURBO POWERSHIFT) Séries 1 & 2 Series MT835, MT1330, MT1337, MT1637 Série 1 Serie	44/876-6 (214241) 585mm - 500N		
M26-2, M26-4, M30-2, M40-2, M40-4 Séries 1 & 2 Series MC30	44/876-7 (213461) 585mm - 600N		
MT930	44/876-8 (404719) 385mm - 400N		
M30-4 MC40, MC50, MC60, MC70 (⇒S170800) MT732, MT835, MT932, MT1332H, MT1337, MT1637, MLT629, MLT633, MLT730, MLT735H, MLT740H, MLT740T	44/876-9 (226681, 240923) 525mm - 600N		
165ATJ, 165ATJS Série 2 Serie	44/876-10 (498524) 360mm - 350N		
MLT523, MLT526 Série 1 Serie	44/876-11 (232509) 885mm - 500N	44/876-12 (223523) 585mm - 700N	
MLA628T MLT523, MLT526 Série 1 Serie	44/876-12 (223523) 585mm - 700N		
MC60, MT727, MT728, MT927, MT928, MLT628, MLT632, MLT728	44/876-15 (209377) 885mm - 400N		
M2 26 CP, M2 30 CP, M4 26 CP, M4 30 CP, M4 40 CP, M4 50 CP, MC 30 CP, MC 40 CP, MC 50 CP, MCE 40 CP, MLT523, MLT526 Série 1 Serie	44/876-16 (174114) 585mm - 400N		
MT725, MT727, 927 SÉRIE C SERIE MT830, MT840, MT930, MT1230 Séries 2 & 3 Series	44/876-17 (78442) 885mm - 800N		
MLT626, MLT630, MLT725 Séries 2 & 3 Series		44/876-20 (189010) 885mm - 600N	
MSI20N MSI25, MSI30	44/876-18 (211101) 500mm - 2100N		
MT830, MT840, MT930, MT1230 Série 1 Serie		44/876-21 (184499) 885mm - 800N	
MLT626 Série 1 Serie	44/876-19 (78857) 885mm - 1000N		
MT732, MT835, MT845, MT932, MT940, MT1232, MT1240, MT1330, MT1332, MT1337, MT1637 MLT523, MLT526, MLT629, MLT633, MLT634, MLT730 Série A Serie			44/870-102 (551569) 315mm - 150N

POIGNÉES ET SERRURES
LOCKS & HANDLES

Réf. Ref.	OEM	Description	Fig.
44/4170-63	561428	Poignée de porte de cabine Cab door handle	
44/4170-67	61755	Poignée de porte de cabine avec serrure Cab door handle with lock	
44/4170-64	549701	Poignée de pare-brise Windscreen handle	
44/4170-65	195535	Poignée Handle	
44/4170-153	182110	Serrure intérieure Inner lock	
44/4170-157	573142	Serrure intérieure Inner lock	
44/4170-158	573141	Serrure intérieure Inner lock	
44/4170-154	179531	Serrure complète / Complete lock Types d'engins / Machines types MT / CP 222, 225, 231, 422, 425, 431	
44/4170-66	551562	Charnière Hinge	
44/4170-159	551572	Charnière Hinge	

RÉTROVISEURS MIRRORS



1



2



3



4

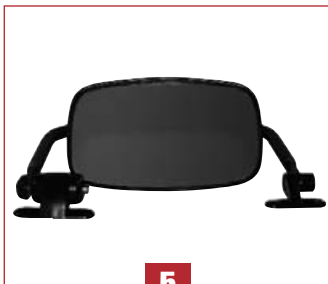

5



6



7

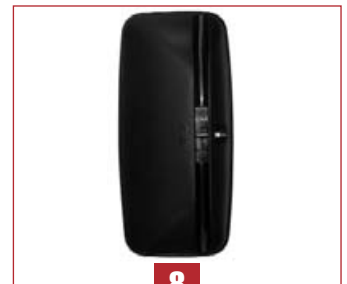

8

Réf. Ref.	OEM	Description	Mesures Sizes	Fig.
44/850-13	676069	Rétroviseur panoramique 180° Panoramic mirror 180°	335 x 185 x 160	1
44/851-25	545816	Rétroviseur panoramique Panoramic mirror	-	2
44/850-16	174096	Complet : Droit ou gauche Complete : Right or left	195 x 145	3
44/851-26	205809	Rétroviseur Mirror	240 x 155	4
44/850-17	179507	Complet Complete		5
44/850-18	182168	Complet droit Complete right	230 x 180	6
44/850-19	182167	Complet gauche Complete left		
44/850-20	551451	Complet gauche Complete left	240 x 155	7
44/850-21	572281ACC	Complet droit Complete right		
44/850-22	74367	Rétroviseur plat Flat mirror	420 x 220	8

BLOQUAGE DE PORTE
DOOR STOPPING

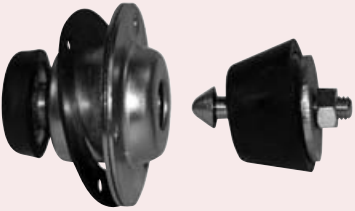
Réf. Ref.	OEM	Fig.
44/4170-156	550649	

PLAFONNIER
ROOF LAMP

Réf. Ref.	OEM	Description	Fig.
44/1922-1	549064		
63/1955-239		Ampoule / Bulb 12V/5W	
63/1955-242		Ampoule / Bulb 24V/5W	

CATADIOPTRE TRIANGULAIRE
RED WARNING TRIANGLE

Réf. Ref.	Mesures Sizes	Fig.
63/1963-1	155 x 135 mm	

BLOQUAGE DE DIRECTION
STEERING IMMOBILIZATION

Réf. Ref.	OEM	Description	Fig.
44/4170-155	676033	Securilock : immobilise la direction Securilock : steering immobilization	

BOULES DE VOLANT STEERING KNOBS

Réf. Ref.	OEM	Fig.
70/4178-2	400160	1
70/4178-3	400160M	2



PARE SOLEIL SUN VISOR

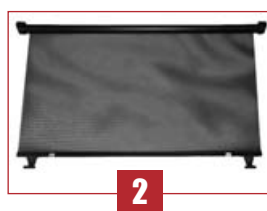

Réf. Ref.	OEM	Description	Mesures Sizes	Fig.
Hublot de toit / Roof window				
70/4181-1	211524	Type M - MC - MT 8/17 m M - MC - MT 8/17 m type	A : 475 mm B : 535 mm	1
70/4181-5	600733	Type MLT / MLT type	A : 660 mm B : 220 mm	1
70/4181-2	600730	Type MLT / MLT type	A : 675 mm B : 725 mm	2
Pare-brise / Windscreen				
70/4181-4	242174	Type MT 8/17 m / MT 8/17 m type	A : 685 mm B : 645 mm	2
70/4181-3	199153	Type M - MC / M - MC type	A : 490 mm B : 190 mm	3

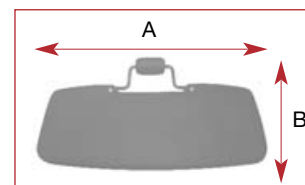
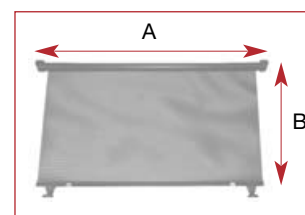

PEINTURES PAINTS

Teinte Colour	1L	5L	Spray
Rouge Manitou / Manitou red	64/3102-410	64/3102-402	64/3102-404
Brun Manitou / Manitou brown	64/3102-400	-	64/3102-406
Noir brillant / Bright black	64/3102-218	64/3102-219	64/3102-220
Noit mat / Mat black	64/3102-206	64/3102-207	64/3102-208

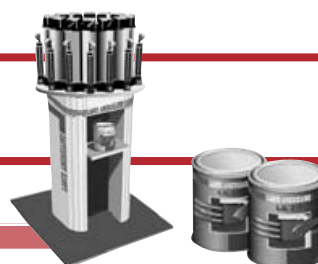

LAQUE AMERICAINE

La meilleure peinture du marché
The best paint on the market

Plus de 2000 nuances possibles
Possibilité de créer une couleur
suivant échantillon

More than 2000 colors available
Possibility to create a color
from a sample

RÉFÉRENCES INTERCHANGEABLES
CROSS REFERENCES

OEM OEM	Réf. Ref.	Page Page	OEM OEM	Réf. Ref.	Page Page	OEM OEM	Réf. Ref.	Page Page	OEM OEM	Réf. Ref.	Page Page
874	44/1931-53	34	49875	63/951-94	31	176737	63/1995-4	32	223595	63/1931-35	35
928	44/566-326	43	53840	44/566-309	42	176797	44/566-307	42	223596	63/1931-34	35
1371	44/1913-172	33	54556	44/1980-38	48	177129	60/161-209	19,20,22,25,26	224580	44/1931-91	35
1752	44/1918-116	33	54557	70/1987-64	47	177130	60/161-208	19-26	224581	44/1931-92	35
2163	44/1912-201	33	58862	63/950-91	31	177178	60/162-209	19, 22, 26	224718	44/153-123	15
6060	44/495-236	41	58863	63/951-20	31	177179	60/162-208	19-26	224734bis	44/5000-110	37
6063	44/495-237	41	61755	44/4170-67	51	177896	44/566-316	42, 43	225199	44/432-4	38
6783	44/566-337	43	62415	44/105-41	12	178924	63/950-81	30	226426	44/154-121	15
8779	44/566-325	43	72431	70/1987-65	47	179507	44/850-17	52	226681	44/876-9	50
18992	63/1970-2	32	74367	44/850-22	52	179531	44/4170-154	51	231803	44/144-520	16
20001	63/958-87	31	75998	44/566-316	42, 43	182110	44/4170-153	51	232509	44/876-11	50
20125	63/1995-5	32	76925	63/1995-3	32	182167	44/850-19	52	233919	63/958-86	31
20997	44/181-73	34	78442	44/876-17	50	182168	44/850-18	52	234133	44/140-2	15
24456	44/566-310	42	78745	44/154-122	15	182819	70/1987-63	47	234944	44/153-123	15
25237	44/566-307	42	78857	44/876-19	50	184526	44/1985-6	47	234956	63/958-88	31
33479	44/200-172	36	85282	70/1987-6	47	184499	44/876-21	50	235137	44/153-122	15
49003	44/42-29	10	89135	70/1987-68	47	184817	63/950-89	31	236094	60/240-106	22, 26
49004	44/43-28	10	89136	44/1985-17	47	184818	63/951-90	31	236148	44/1931-46	32
49005	44/2-109	7	105548	60/97-56	19, 26	185578	60/161-207	19-24, 26	23737R	62/920-4	44
49007	44/31-224	8	106375	44/316-25	37	188920	44/153-121	15	23737R	62/920-10	44
49008	44/11-109	7	106387	60/97-1	19, 25, 26	189007	44/181-68	34	238131	69/7639-2	46
49009	44/13-109	7	107349	44/6408-42	39	189008	44/181-72	34	23962R	62/920-4	44
49010	44/34-184	8, 9	108100	44/6408-40	39	189008R	44/181-68	34	23962R	62/920-10	44
49011	44/28-109	7	108511	63/950-93	31	189010	44/876-20	50	239478	44/1743-2	29
49013	44/144-500	16	108914	44/6453-125	39	191384	63/958-85	31	239479	44/1743-1	29
49014	44/144-519	16	108915	44/6453-124	39	193155	70/1987-30	47	240923	44/876-9	50
49022	44/231-172	36	108916	44/6453-123	39	195535	44/4170-65	51	242174	70/4181-4	54
49023	44/420-90	38	108948	44/6408-37	39	197297	44/566-317	43	257524	44/144-505	17
49054	44/566-330	42	108965	44/6408-38	39	198069	63/958-89	31	400160	70/4178-2	54
49057	44/144-526	16	108991	44/495-272	41	198126	44/1980-85	48	400160M	70/4178-3	54
49064	44/418-90	38	109281	62/930-38	44	198127	44/1985-5	47	401172	63/1885-8	27
49071	44/100-112	12	109437	44/144-501	16	198290	70/1987-66	47	404719	44/876-8	50
49086	44/60-44	13	109555	44/6408-47	39	199153	70/4181-3	54	418601T	63/1973-4	28
49138	44/40-10	10	109594	44/316-22	37	199412	44/1980-39	49	419491	63/1970-23	28
49139	44/41-31	10	109533	44/6450-124	39	199414	44/1980-72	48	419560	63/1970-20	28
49174	44/25-29	7	109753	44/6403-112	37	199624	44/410-49	37	420189	44/495-273	41
49180	44/80-15	10	128680	60/97-39	20, 26	199955	44/1989-4	47	449375	44/316-23	37
49183	44/424-90	38	133755	60/97-2	19-26	199956	44/1989-6	47	449376	44/317-21	37
49190	44/130-215	14	133757	44/60-45	13	202659	44/1980-33	48	453958	63/1971-23	28
49196	44/419-90	38	133989	44/423-17	38	205243	44/1980-38	48	453959	63/1970-18	28
49206	60/112-1	13	136163	60/97-36	19, 26	205809	44/851-26	52	454023	63/1970-19	28
49250	44/417-90	38	136353	44/566-352	37	208756	44/144-506	17	454024	63/1971-24	28
49261	44/1-109	7	136508	60/97-30	20, 26	208889	44/1980-72	48	454542	44/1980-35	48
49297	44/130-215	14	162841	63/958-84	31	209377	44/876-15	50	466212	44/1931-54	34
49311	44/41-32	10	163782	44/1912-211	33	209847	44/140-1	15	473010	63/1970-22	28
49319	44/221-240	36	163783	44/1912-210	33	211101	44/876-18	50	473390	44/1980-70	48
49329	44/432-3	38	163825	63/1955-500	33	211524	70/4181-1	54	473557	44/144-503	16
49364	44/44-22	10	165598	44/1913-191	33	212846	44/566-337	43	473671	44/6408-45	39
49365	44/45-18	10	165599	44/1913-192	33	213461	44/876-7	50	473722	44/144-503	16
49445	60/96-1	19, 20, 25, 26	166347	63/1971-2	32	214241	44/876-6	50	473724	44/130-255	14
49532	44/230-172	36	167787	70/1987-7	47	216933	44/144-507	17	473832	44/422-70	38
49536	44/38-10	8	169469	60/161-38	19, 25, 26	217366	62/920-4	44	473834	44/416-40	38
49537	44/35-78	8, 9	173284	44/566-307	42	217366	62/920-10	44	473835	44/416-37	38
49541	44/33-188	8	174055	44/1980-32	49	221174	60/240-104	20-24, 26	473837	44/416-39	38
49544	44/3-109	7	174096	44/850-16	52	223523	44/876-12	50	473838	44/416-38	38
49660	60/111-3	19-26	174114	44/876-16	50	223258	44/144-505	17	473868	44/6408-44	39
49667	60/110-2	13	175201	44/1985-4	47	223480	44/1931-55	34	473892	44/6408-41	39
49750	44/117-64	13	175856	44/1980-34	48	223594	63/1885-2	27	474683	44/495-171	41

Les références des pièces sont indicatives.
Nos pièces ne sont pas d'origine

"THE RELIABLE SERVICE"

Part numbers are quoted for reference purposes only.
Our parts and accessories are not original.

RÉFÉRENCES INTERCHANGEABLES CROSS REFERENCES

OEM OEM	Réf. Ref.	Page Page	OEM OEM	Réf. Ref.	Page Page	OEM OEM	Réf. Ref.	Page Page	OEM OEM	Réf. Ref.	Page Page
474948	44/144-502	16	549339	44/6408-43	39	601221	44/490-26	40			
475270	44/6450-123	39	549553	44/100-113	12	601220	44/490-25	40			
475393	44/6408-46	39	549701	44/4170-64	51	601223	44/496-53	40			
475499	44/144-515	18	549800	44/144-513	18	601464	44/144-509	18			
475796	44/422-38	38	550649	44/4170-156	53	601464	44/144-510	18			
476010	44/144-508	17	551322	44/1918-140	33	604656	44/6408-55	39			
476152	44/144-523	17	551450	44/1989-5	47	610092	44/1980-33	48			
476170	60/112-1	13	551451	44/850-20	52	661500	44/497-181	41			
476954	60/97-3	19-26	551562	44/4170-66	51	661501	44/495-181	41			
477279	44/423-16	38	551563	44/1985-6	47	661973	44/1912-178	33			
477419	60/112-2	13	551572	44/4170-159	51	676033	44/4170-155	53			
477709	44/422-39	38	551814	44/1918-141	33	676069	44/850-13	52			
477791	44/144-523	17	551841	70/1987-64	47	691723	70/1987-66	47			
477796	44/490-31	41	551874	70/1987-38	47	708294R93	44/100-112	12			
478031	44/422-40	38	552500	44/144-514	18	714854R1	44/38-11	8			
478128	44/422-41	38	561299	44/144-504	16	1637718E	44/144-516	18			
485268	44/1976-4	32	561414	62/930-38	44	26560143	60/111-26	21, 26			
485221	63/1740-9	27	561428	44/4170-63	51	2666108	44/60-45	13			
485222	63/1741-10	27	561557	44/495-238	41	2802315MI	70/1987-600	47			
485223	63/1740-8	27	5618T	63/1970-21	28	3050149R92	44/34-185	8, 9			
485224	63/1741-8	27	562054	44/1980-73	48	3064060R91	44/90-82	12			
485241	63/1742-11	27	562516	44/423-19	38	631TH87	44/1980-76	48			
485242	63/1742-12	27	563270	44/144-521	16	6310913	44/1985-17	47			
486356	63/1973-3	28	563415	60/162-206	19-24, 26	2871A141	62/920-108	44			
485696	60/240-147	25, 26	563416	60/161-206	19-24, 26	2871A163	62/920-108	44			
484952	60/162-207	19-24, 26	564744	44/1913-173	33	2873B056	62/930-38	44			
489768	44/168-26	26	564765	44/7703-7	38	2873B071	62/930-38	44			
490393	63/1971-22	28	564916	44/1989-3	47	2873B072	62/930-80	44			
490394	63/1970-17	28	565666	44/144-511	18	90916-02952-71	44/144-517	18			
498524	44/876-10	50	572281ACC	44/850-21	52	AAU2906	44/221-241	36			
505556	44/6403-111	37	573046	44/1989-2	47	AVX 10-775	44/144-519	16			
545534	44/1980-40	49	573113	70/1987-7	47	AVX 13-750	44/144-526	16			
551330	44/1980-73	48	573117	44/1985-4	47	AVX 17-825	44/144-500	16			
551567	44/1980-74	48	573141	44/4170-158	51	B1036	44/72-325	11			
551569	44/870-102	50	573142	44/4170-157	51	R4485	44/6408-54	39			
552760	44/1980-75	48	573199	44/1980-37	48	U5MW0092	44/130-255	14			
561749	60/240-102	20-24, 26	573213	44/1985-6	47	U5MW0108	44/130-254	14			
563482	60/240-105	22, 26	573214	70/1987-6	47	U5MW0157	44/130-256	14			
563483	60/240-103	22, 23, 26	582075	44/1931-56	35	U7LW0058	44/131-253	14			
563841	44/1980-31	49	587421	44/1912-212	33	U7LW0096	44/131-254	14			
573050	44/1980-36	48	587422	44/1912-213	33	U7LW0151	44/131-255	14			
573067	63/2000-105	30	600733	70/4181-5	54	ULPK0005	44/100-113	12			
573070	44/1980-71	48	600730	70/4181-2	54						
573125	44/1980-37	48	600737	44/1985-7	47						
582458	63/1973-2	28	601207	44/490-29	40						
605013	60/111-176	25, 26	601208	44/490-30	40						
610075	44/1980-32	49	601209	44/497-179	40, 41						
501058	44/6408-48	39	601210	44/495-175	40						
501266	44/423-18	38	601211	44/496-55	40						
503965	44/144-518	17	601212	44/490-27	40						
508118	44/1924-2	35	601213	44/490-28	40						
545816	44/851-25	52	601214	44/495-174	40						
549064	44/1922-1	53	601215	44/496-54	40						
549253	44/416-43	38	601216	44/490-23	40						
549259	44/6408-39	39	601217	44/490-24	40						
549313	44/422-42	38	601218	44/495-172	40						
549314	44/422-43	38	601219	44/496-52	40						
549322	44/416-44	38	601222	44/495-173	40						

Les références des pièces sont indicatives.
Nos pièces ne sont pas d'origine

"THE RELIABLE SERVICE"

Part numbers are quoted for reference purposes only.
Our parts and accessories are not original.

INDEX DES RÉFÉRENCES
REFERENCE INDEX

OEM OEM	Page Page	OEM OEM	Page Page	OEM OEM	Page Page	OEM OEM	Page Page
44/1-109	.7	44/144-516	.18	44/490-26	.40	44/851-25	.52
44/2-109	.7	44/144-517	.18	44/490-27	.40	44/851-26	.52
44/3-109	.7	44/144-518	.17	44/490-28	.40	44/870-102	.50
44/11-109	.7	44/144-519	.16	44/490-29	.40	44/876-6	.50
44/13-109	.7	44/144-520	.16	44/490-30	.40	44/876-7	.50
44/25-29	.7	44/144-521	.16	44/490-31	.41	44/876-8	.50
44/28-109	.7	44/144-523	.17	44/495-171	.41	44/876-9	.50
44/31-224	.8	44/144-526	.16	44/495-172	.40	44/876-10	.50
44/31-225	.8	44/153-121	.15	44/495-173	.40	44/876-11	.50
44/33-188	.8	44/153-122	.15	44/495-174	.40	44/876-12	.50
44/34-184	.8, 9	44/153-123	.15	44/495-175	.40	44/876-15	.50
44/34-185	.8, 9	44/153-252	.15	44/495-181	.41	44/876-16	.50
44/35-78	.8, 9	44/154-120	.15	44/495-236	.41	44/876-17	.50
44/38-10	.8	44/154-121	.15	44/495-237	.41	44/876-18	.50
44/38-11	.8	44/154-122	.15	44/495-238	.41	44/876-19	.50
44/40-10	.10	44/154-252	.15	44/495-270	.41	44/876-20	.50
44/41-31	.10	44/168-26	.26	44/495-271	.41	44/876-21	.50
44/41-32	.10	44/1743-1	.29	44/495-272	.41	44/1912-178	.33
44/42-29	.10	44/1743-2	.29	44/495-273	.41	44/1912-201	.33
44/43-28	.10	44/181-68	.34	44/496-52	.40	44/1912-210	.33
44/44-22	.10	44/181-72	.34	44/496-53	.40	44/1912-211	.33
44/45-18	.10	44/181-73	.34	44/496-54	.40	44/1912-212	.33
44/60-44	.13	44/186-39	.29	44/496-55	.40	44/1912-213	.33
44/60-45	.13	44/200-1450KT	.36	44/497-179	.40, 41	44/1913-172	.33
44/71-324	.11	44/200-1451KT	.36	44/497-181	.41	44/1913-173	.33
44/71-325	.11	44/200-1452KT	.36	44/497-270	.41	44/1913-191	.33
44/72-325	.11	44/200-172	.36	44/566-306	.42	44/1913-192	.33
44/73-324	.11	44/200-173	.36	44/566-307	.42	44/1918-116	.33
44/73-325	.11	44/200-174	.36	44/566-308	.42	44/1918-140	.33
44/74-324	.11	44/221-240	.36	44/566-309	.42	44/1918-141	.33
44/74-325	.11	44/221-241	.36	44/566-310	.42	44/1919-82	.33
44/75-324	.11	44/221-242	.36	44/566-311	.42	44/1922-1	.53
44/80-15	.10	44/230-172	.36	44/566-312	.42	44/1924-2	.35
44/90-82	.12	44/231-172	.36	44/566-313	.42	44/1931-46	.32
44/100-112	.12	44/231-174	.36	44/566-314	.42	44/1931-53	.34
44/100-113	.12	44/316-22	.37	44/566-315	.42	44/1931-54	.34
44/105-41	.12	44/316-23	.37	44/566-316	.42, 43	44/1931-55	.34
44/117-64	.13	44/316-25	.37	44/566-317	.42, 43	44/1931-56	.35
44/117-211	.13	44/317-21	.37	44/566-318	.42	44/1931-91	.35
44/130-215	.14	44/410-49	.37	44/566-319	.42	44/1931-92	.35
44/130-249	.14	44/416-37	.38	44/566-320	.42	44/1976-4	.32
44/130-250	.14	44/416-38	.38	44/566-321	.43	44/1980-31	.49
44/130-251	.14	44/416-39	.38	44/566-322	.43	44/1980-32	.49
44/130-252	.14	44/416-40	.38	44/566-323	.43	44/1980-33	.48
44/130-253	.14	44/416-43	.38	44/566-324	.43	44/1980-34	.48
44/130-254	.14	44/416-44	.38	44/566-325	.43	44/1980-35	.48
44/130-255	.14	44/417-90	.38	44/566-326	.43	44/1980-36	.48
44/130-256	.14	44/418-90	.38	44/566-327	.43	44/1980-37	.48
44/131-253	.14	44/419-90	.38	44/566-328	.43	44/1980-38	.48
44/131-254	.14	44/420-90	.38	44/566-329	.42	44/1980-39	.49
44/131-255	.14	44/422-38	.38	44/566-330	.43	44/1980-40	.49
44/140-1	.15	44/422-39	.38	44/566-331	.43	44/1980-70	.48
44/140-2	.15	44/422-40	.38	44/566-332	.43	44/1980-71	.48
44/144-500	.16	44/422-41	.38	44/566-333	.43	44/1980-72	.48
44/144-501	.16	44/422-42	.38	44/566-334	.43	44/1980-73	.48
44/144-502	.16	44/422-43	.38	44/566-335	.43	44/1980-74	.48
44/144-503	.16	44/422-70	.38	44/566-336	.43	44/1980-75	.48
44/144-504	.16	44/423-16	.38	44/566-337	.43	44/1980-76	.48
44/144-505	.17	44/423-17	.38	44/566-338	.43	44/1980-85	.48
44/144-506	.17	44/423-18	.38	44/566-352	.37	44/1985-4	.47
44/144-507	.17	44/423-19	.38	44/850-13	.52	44/1985-5	.47
44/144-508	.17	44/424-90	.38	44/850-16	.52	44/1985-6	.47
44/144-509	.18	44/432-3	.38	44/850-17	.52	44/1985-7	.47
44/144-510	.18	44/432-4	.38	44/850-18	.52	44/1985-17	.47
44/144-511	.18	44/435-90	.38	44/850-19	.52	44/1989-2	.47
44/144-513	.18	44/490-23	.40	44/850-20	.52	44/1989-3	.47
44/144-514	.18	44/490-24	.40	44/850-21	.52	44/1989-4	.47
44/144-515	.18	44/490-25	.40	44/850-22	.52	44/1989-5	.47

Les références des pièces sont indicatives.
Nos pièces ne sont pas d'origine

"THE RELIABLE SERVICE"

Part numbers are quoted for reference purposes only.
Our parts and accessories are not original.

INDEX DES RÉFÉRENCES REFERENCE INDEX

OEM OEM	Page Page	OEM OEM	Page Page	OEM OEM	Page Page	OEM OEM	Page Page
44/1989-6	.47	60/161-38	.19, 25, 26	63/1955-453	.34, 35	69/9483-1	.46
44/4170-63	.51	60/161-206	.19-24, 26	63/1955-460	.34	69/9483-2	.46
44/4170-64	.51	60/161-207	.19-24, 26	63/1955-500	.33	69/9483-3	.46
44/4170-65	.51	60/161-208	.19-26	63/1955-501	.35	69/9483-10	.46
44/4170-66	.51	60/161-209	.19, 20, 22, 25, 26	63/1955-615	.34	69/9483-11	.46
44/4170-67	.51	60/162-206	.19-24, 26	63/1963-1	.53	69/9483-12	.46
44/4170-153	.51	60/162-207	.19-24, 26	63/1970-2	.32	69/9490-30	.46
44/4170-154	.51	60/162-208	.19-24, 26	63/1970-17	.28	69/9490-31	.46
44/4170-155	.53	60/162-209	.19, 22, 26	63/1970-18	.28	69/9490-32	.46
44/4170-156	.53	60/168-50	.26	63/1970-19	.28	69/9490-33	.46
44/4170-157	.51	60/168-51	.26	63/1970-20	.28	69/9496-1	.46
44/4170-158	.51	60/168-52	.26	63/1970-21	.28	69/9496-2	.46
44/4170-159	.51	60/240-102	.20-24, 26	63/1970-22	.28	69/9496-3	.46
44/5000-110	.37	60/240-103	.22, 23, 26	63/1970-23	.28	69/9496-10	.46
44/6403-106	.41	60/240-104	.20-24, 26	63/1971-2	.32	69/9496-11	.46
44/6403-107	.41	60/240-105	.22, 26	63/1971-22	.28	69/9496-12	.46
44/6403-108	.41	60/240-106	.22, 26	63/1971-23	.28	70/1987-6	.47
44/6403-111	.37	60/240-147	.25, 26	63/1971-24	.28	70/1987-7	.47
44/6403-112	.37	62/920-4	.44	63/1973-2	.28	70/1987-30	.47
44/6407-67	.39	62/920-10	.44	63/1973-3	.28	70/1987-38	.47
44/6407-68	.39	62/920-108	.44	63/1973-4	.28	70/1987-63	.47
44/6408-37	.39	62/930-5	.44	63/1995-3	.32	70/1987-64	.47
44/6408-38	.39	62/930-38	.44	63/1995-4	.32	70/1987-65	.47
44/6408-39	.39	62/930-80	.44	63/1995-5	.32	70/1987-66	.47
44/6408-40	.39	63/950-44	.30	63/2000-105	.30	70/1987-68	.47
44/6408-41	.39	63/950-81	.30	64/3102-206	.54	70/1987-600	.47
44/6408-42	.39	63/950-82	.30	64/3102-207	.54	70/4178-2	.54
44/6408-43	.39	63/950-89	.31	64/3102-208	.54	70/4178-3	.54
44/6408-44	.39	63/950-91	.31	64/3102-218	.54	70/4181-1	.54
44/6408-45	.39	63/950-93	.31	64/3102-219	.54	70/4181-2	.54
44/6408-46	.39	63/951-20	.31	64/3102-220	.54	70/4181-3	.54
44/6408-47	.39	63/951-90	.31	64/3102-400	.54	70/4181-4	.54
44/6408-48	.39	63/951-94	.31	64/3102-402	.54	70/4181-5	.54
44/6408-54	.39	63/958-84	.31	64/3102-404	.54	70/tub 1220	.15
44/6408-55	.39	63/958-85	.31	64/3102-406	.54	70/tub 1225	.15
44/6413-123	.39	63/958-86	.31	64/3102-410	.54	70/tub 1231	.15
44/6450-123	.39	63/958-87	.31	65/9604-401	.29	70/tub 1233	.15
44/6450-124	.39	63/958-88	.31	69/7639-2	.46	70/tub 1237	.15
44/6452-123	.39	63/958-89	.31	69/9068-1	.45	70/tub 1244	.15
44/6452-124	.39	63/1740-8	.27	69/9068-2	.45	70/tub 1248	.15
44/6453-123	.39	63/1740-9	.27	69/9068-3	.45	70/tub 1255	.15
44/6453-124	.39	63/1741-8	.27	69/9448-1	.45	70/tub 1265	.15
44/6453-125	.39	63/1741-10	.27	69/9465-2	.45	70/tub 1280	.15
44/6462-123	.39	63/1742-11	.27	69/9465-5	.45	82/9202-453	.49
44/6462-124	.39	63/1742-12	.27	69/9465-8	.45		
44/7703-7	.38	63/1881-1	.30	69/9465-10	.45		
60/96-1	.19, 20, 25, 26	63/1881-2	.30	69/9465-11	.45		
60/96-14	.20, 26	63/1881-18	.30	69/9466-2	.45		
60/96-2	.19, 26	63/1881-19	.30	69/9466-5	.45		
60/96-3	.19, 20, 25, 26	63/1881-20	.30	69/9466-8	.45		
60/96-7	.19, 20, 25, 26	63/1881-21	.30	69/9466-10	.45		
60/97-1	.19, 25, 26	63/1882-2	.30	69/9466-11	.45		
60/97-2	.19-26	63/1882-3	.30	69/9471-2	.45		
60/97-3	.19-26	63/1882-7	.30	69/9471-3	.45		
60/97-30	.20, 26	63/1882-8	.30	69/9471-5	.45		
60/97-36	.19, 26	63/1885-1	.27	69/9471-6	.45		
60/97-39	.20, 26	63/1885-2	.27	69/9471-7	.45		
60/97-54	.20, 25, 26	63/1885-8	.27	69/9471-8	.45		
60/97-56	.19, 26	63/1931-34	.35	69/9471-9	.45		
60/97-97	.25, 26	63/1931-35	.35	69/9471-15	.45		
60/110-2	.13	63/1955-207	.33	69/9472-2	.45		
60/111-3	.19-26	63/1955-239	.33	69/9472-3	.45		
60/111-25	.20, 25, 26	63/1955-242	.53	69/9472-5	.45		
60/111-26	.21, 26	63/1955-250	.34, 35	69/9472-6	.45		
60/111-45	.19, 26	63/1955-287	.35	69/9472-7	.45		
60/111-176	.25, 26	63/1955-382	.32, 33	69/9472-8	.45		
60/112-1	.13	63/1955-410	.34	69/9472-9	.45		
60/112-2	.13	63/1955-448	.34	69/9472-15	.45		

Les références des pièces sont indicatives.
Nos pièces ne sont pas d'origine

"THE RELIABLE SERVICE"

Part numbers are quoted for reference purposes only.
Our parts and accessories are not original.